

Industrial Connectivity Solutions

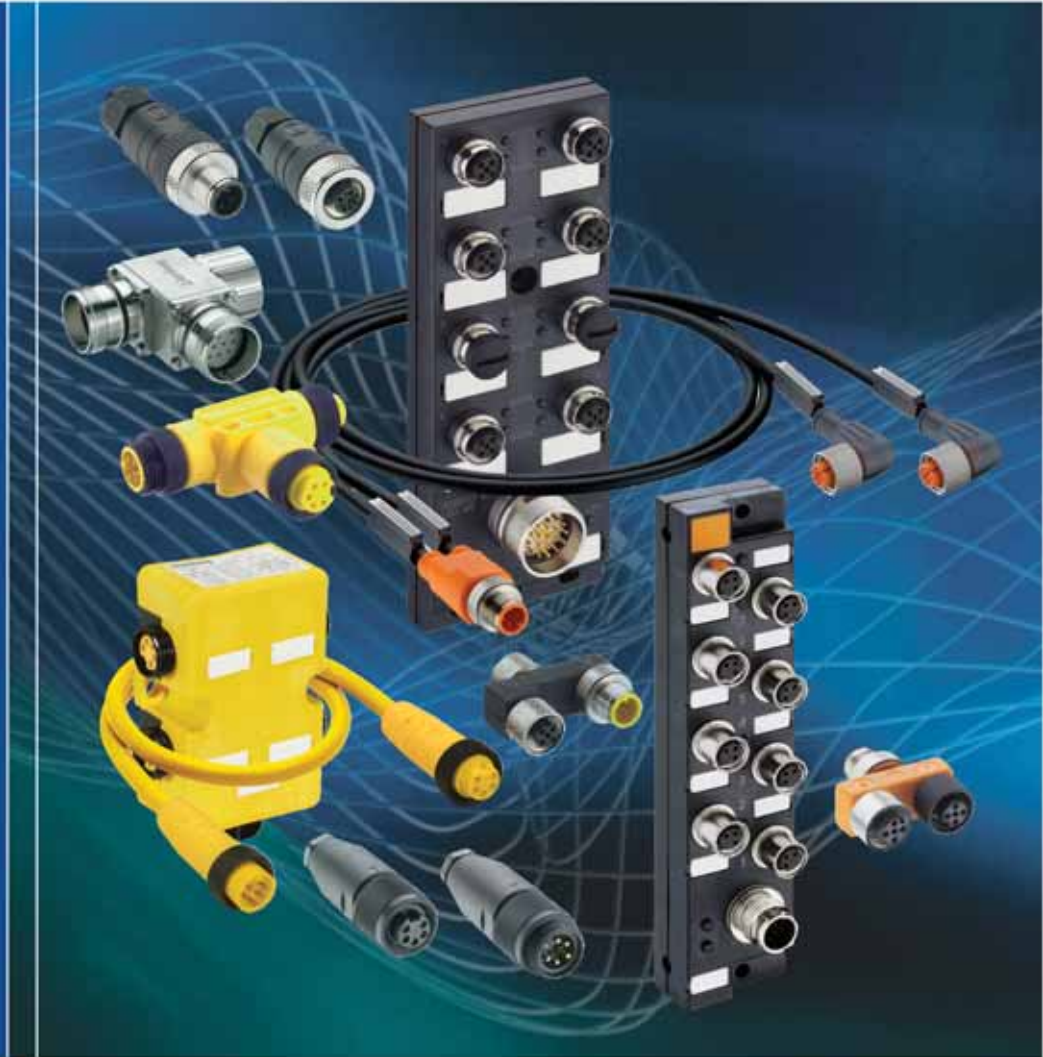

**Connectors and Components
for Automation Technology**



Lumberg Automation™ Provides
Reliable Connectivity Solutions for
Industrial Automation Applications
Worldwide.





Belden® Industrial Solutions — More Convenience and More Solutions for Networks in Harsh Environments and Large-scale Infrastructures

Belden Industrial Solutions

For mission-critical applications, Belden is the signal transmission partner that delivers confidence in signal availability, integrity and performance because only Belden can offer solutions that satisfy any requirement.

A majority of system failures occur within the signal transmission space, and trouble-shooting can be very difficult and time-consuming. We want everyone to "**Be Certain**" that when choosing Belden you receive **Signal Availability** — always there, **Signal Integrity** — always trusted and secure, and **Signal Performance** — always when and where you need it.

Belden has brought together a comprehensive line of industrial cabling, connectivity and networking devices, offering the most reliable communications solutions for your application. Whether you are networking your devices to the controllers, connecting the controllers to the control room, relaying data between the control room, the engineering department, and remote manufacturing sites — or all of the above — Belden has the products you need to seamlessly connect your communications.

From the petrochemical, automotive, pharmaceutical, power generation, pulp and paper, metals, food and beverage, or general manufacturing plant to the corporate headquarters — and everywhere in between — Belden has your signal transmission solution. Belden offers the most dependable network and communications system performance in tough and mission-critical environments.

Our Synergy Ensures Continuous Performance

With the Hirschmann™ and Lumberg Automation™ product line additions to the Belden offering, our line of Complete Industrial Solutions is uniquely positioned to provide the best network and communications infrastructure possible. Belden products and systems expertise means that you can maintain ongoing operations without interruption and costly downtime — in any environment.

Here are a few more good reasons why Belden is your best choice for industrial networking, communications and control:

- We have the expertise to integrate your industrial and commercial networks.
- Our products are engineered to perform in tough and difficult environments.
- We offer the broadest selection of products, for a complete, end-to-end Ethernet solution.
- Our sales and engineering professionals can audit, recommend/design, configure and assemble the products and systems to your specific requirements.
- Our global manufacturing and distribution network make our products available to you globally.

Offering Comprehensive Service & Support

Belden recognizes that comprehensive know-how is necessary to ensure an optimized, homogenous solution. We also know that consultation, support and training requires more than just a general understanding of the products, technologies and market trends. It requires a solid understanding of the application and the ability to provide the type of support that is needed — when and where it is needed. It requires the four key service and support areas that are critical to success:

- Network Design
- Training
- Technical Support
- System Performance

Network Design

Belden eliminates your design challenges because we understand the issues surrounding the design and operation of networks in industrial and mission-critical environments. Our engineers are available to work with you to deliver high-availability networks that meet your enterprise-wide IT needs. Whether it's designing systems for Greenfield facilities, or integrating into existing industrial IT environments, our highly-trained staff lifts the design burden from your shoulders to ours.

We'll consult with you to develop a strategy — or we'll develop and implement your full design — either way our staff is available to you.

Training

Backed by years of meeting and exceeding the needs of a broad range of end-user applications, Belden is ideally suited to offer beginners and networking experts alike the opportunity to expand their understanding of mission-critical industrial networks. Belden has developed a series of training programs that are given by Belden-certified individuals — all experts in industrial networking and cabling.

Technical Support

At Belden, our personnel are poised to assist our customers — ensuring maximum uptime and reliability. And with offices in North America, Asia and Europe, Belden can respond globally.

System Performance

If Belden designs it, we guarantee performance — period. We are committed to ensuring world-class signal connectivity and to significantly improve your operational up-time. All Belden components are "designed" to deliver optimum performance: from connectors, to cable, to routers and switches. Based on this comprehensive product portfolio, we have the necessary industrial solutions DNA to deliver reliability.

For more information on our service and support offering, including our warranties, please go to the Belden web site at www.belden.com/industrial to locate a Belden sales representative near you.

Belden keeps many different and mission-critical operations up and running all around the world.

Belden Products Serve Many Diverse Industries

Processing Industries

Safety is critical in all processing operations. Therefore the best defense is an effective and reliable offense — specifying signal transmission products that have been engineered and manufactured specifically for the process environment. Using Belden products, including Hirschmann- and Lumberg Automation branded products, you can rely on our products to ensure proper and consistent system performance — even in the most demanding and hazardous applications.



Discrete Manufacturing

Uptime and dependability of operations are hallmarks of Belden, Hirschmann and Lumberg Automation products. These products are designed to prevent transmission problems in the factory network which can lead to catastrophic failures and untold costs. With all our products and solutions having been designed to meet and exceed the high demands of our discrete manufacturing customers, comprehensive service and support are part of the offering.



Infrastructure

Control, centralized monitoring and network management perform seamlessly in very demanding applications for our most discriminating infrastructure customers. Whether networking a long underground rail tunnel, a large wastewater complex, an airport in the desert, or power generation facilities in the arctic, Belden, Hirschmann and Lumberg Automation products will deliver continuous network availability and bring efficiency to operations.



Be Certain with Belden



Applications

- Oil, Gas and Petrochemical Processing
- Oil, Drilling and Exploration
- Food and Beverage
- Pharmaceutical Processing
- Pulp and paper Processing
- Chemical Processing
- Cement and Concrete Production
- Coking
- Mining



Applications

- Industrial Equipment
- Machine Tools
- Semiconductors
- Plastics
- Rubber Products
- Electronic Components
- Medical Devices and Equipment
- Automotive
- Consumer Products
- Fabricated Metals
- Construction and Off-road Equipment



Applications

- Water Supply
- Waste Treatment and Management
- Roadway and Railway Tunnels
- Shipyards and Shipping Vessels
- Pipelines
- Security
- Airports
- Bridges
- Rail Yards
- Wind Power
- Power Generation, Transmission and Distribution
- Transportation

The Lumberg Automation™ Brand Sets the Standard for Quality, Reliability and Service.



About Our Solutions

Today, more than ever, manufacturing productivity depends upon seamless data communication and automation systems. Lumberg Automation has assembled one of the most diversified portfolios for industrial connectivity and distributed I/O systems for control applications.

With the advancements in technology and improved machine designs, industrial controls, such as sensors, actuators, safety light curtains, pushbutton switches and the like are moving closer to the application.

Our Enclosure~less™ Concept

The Enclosure~less concept from Lumberg Automation addresses these applications with an entire suite of industrial hardened connectivity and distributed I/O products.

Enhanced environmental characteristics, modular designs, plug-and-play electronics with quick-disconnect designs are all integrated to increase speed of installation, decrease troubleshooting and maintenance while reducing the overall complexity of the control application. These products provide the optimal solution in machine and equipment design and offer excellent opportunities and benefits to OEMs, system integrators, and end users alike.

Easing the Design Process

Our system approach leads to decreased time and money to develop complete integrated connectivity solutions. Using our Enclosure~less concept is one of the most effective ways to dramatically reduce the design time.

Re-Useable Solutions

OEM's now have access to a set of standard products designed around the concept that everything is pluggable and interchangeable.

Having the flexibility to re-configure or expand an existing system without worrying about customization is made possible with our Enclosure~less concept. Most importantly, our products are re-usable and can be adapted to future designs or merely put back on the shelf for future use.

Improved Installation Time with Less Mistakes

A recent study by a group of European manufacturers concluded that Enclosure~less assembly costs save as much as 30 percent over conventional installation methods.

These savings are realized through not only the Enclosure~less concept, but by the technology that is being employed. With a modular design approach and plug-and-play electronic features, less time will be spent running down errors or replacing parts from incorrect wiring.

Trouble-Shooting is Simplified

Troubleshooting circuits can be a long process, especially when one is dealing with several hundred termination points.

Many of our products have integrated LED function indicators which provide a visual notification that a circuit is functioning properly.

By using products that have integrated LED functions, mechanics and engineers alike can quickly isolate and resolve the problem.

Testing Made Simple

OEMs can cost-effectively build and pre-test a machine at their facility, disassemble and transport it to an end user's plant knowing that everything has been tested. This is primarily made possible through the reduction of wiring terminations throughout the system, which makes testing a much simpler and quicker process.

Reliability is Maximized

Enclosure~less™ solutions can minimize wiring errors because wiring is pre-manufactured with quick-disconnect features. With less manual wiring involved, there are fewer points of failure.

Some studies suggest that a large portion of system failures come from installation rather than part failures. The decrease in errors associated with pre-manufactured wiring leads to an increase in the overall reliability of the control system.

In the end, this helps speed installation and commissioning, maintenance, troubleshooting, and ultimately boosts a plant's production.

Maintenance/Repair Time is Reduced

Maintenance technicians and operators no longer need to access the control panel since much of the maintenance and troubleshooting can be done outside.

With the simplicity of wiring layout and connections, end users can efficiently isolate problems and replace a starter or I/O locally, rather than sorting through a complex panel. The result is significantly easier troubleshooting and shorter Mean-Time-To-Repair (MTTR).

Floor Space at a Premium

Control cabinets can occupy a substantial amount of the production floor. The Enclosure~less™ concept dramatically reduces the need for that real estate, allowing companies to leverage more of their facility.

Industries like semiconductor and pharmaceutical manufacturing have realized the benefits of the On-Machine approach for years, as their clean-room space is at a premium.



Table of Contents

Table of Contents	
About Belden® Industrial Solutions	3
Industries Served	4-5
About Our Solutions	6
Table of Contents	7
Connectivity Overview	8-13
Actuator/Sensor Distribution Boxes	14-55
Single-Ended Cordsets	60-137
Double-Ended Cordsets/Extensions	138-192
Splitters and Adapters	192-235
Receptacles	236-297
Field Attachable Connectors	298-335
Accessories	336-340
References	341-365
Part Number Configurations	341-355
Cable Index	356-357
Ingress Protection Classes According to DIN EN 60529 (IEC 529/VDE 047 T1)	358-359
Glossary of Terms	360-365
Part Number Index	366-382

- Distribution Boxes
- Cordsets
Single-Ended
- Cordsets
Double-Ended
- Splitters and
Adapters
- Receptacles
- Field Attachable
Connectors

Connectivity Overview - Mini Series

Distribution Boxes

Mini distribution boxes simplify control wiring while eliminating long cable runs and are ideally suited for harsh industrial environments (IP68 / NEMA 6P rated).

All distribution boxes are equipped with plug-n-play side mounted quick-disconnect ports, and Mini on-board quick-disconnect for home run control cable/extension and come with or without lamp indicators.

Features:

- Ports: 4
- Housing: Rugged polyester (glass filled)
- Contacts: Brass, gold plated contacts
- Lamps: Standard (no LAMPS) or with LAMPS
- Control Cable: Pre-wired Quick-Disconnect
- IP Rating: IP 68 / NEMA 6P rated (Enclosure~Less)

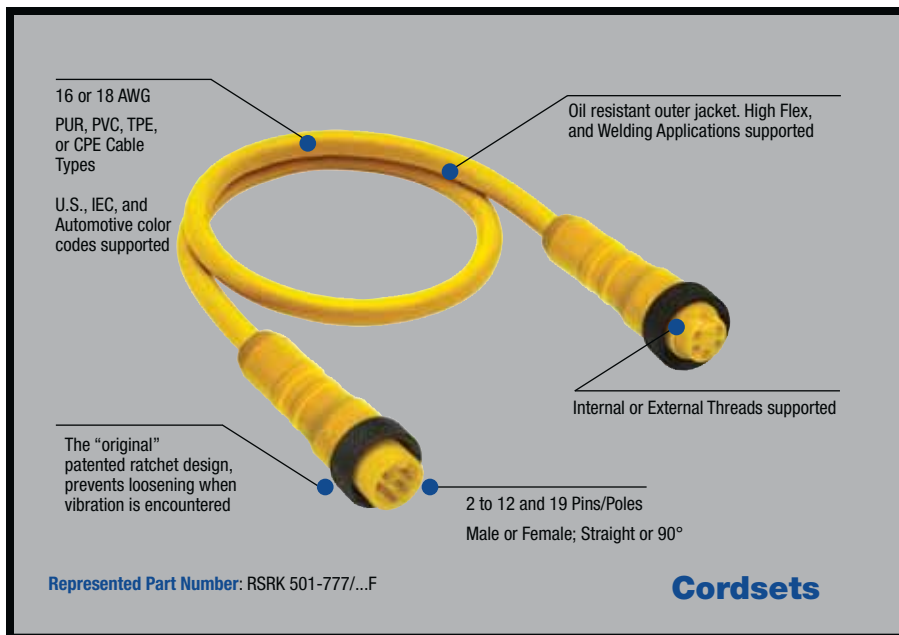
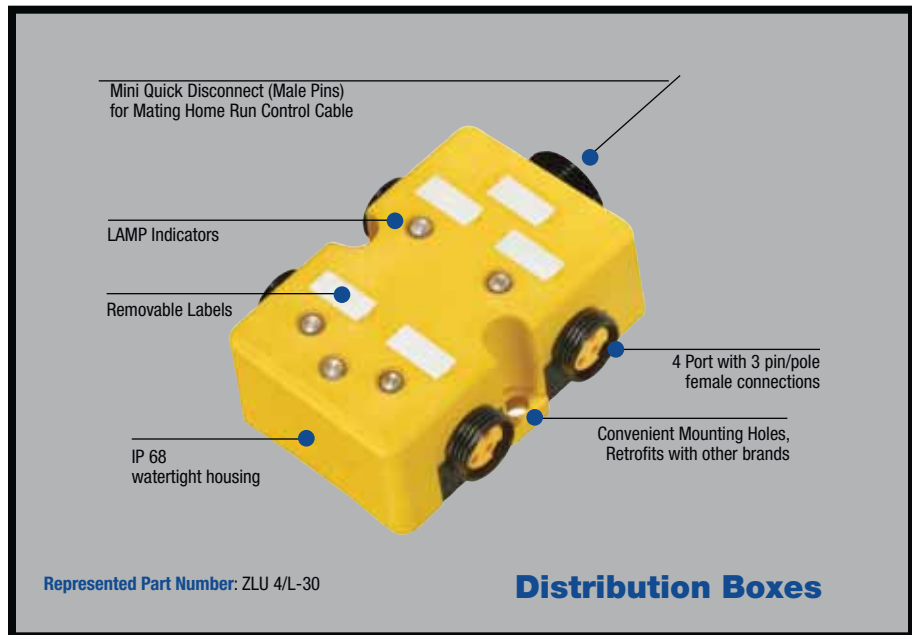

Cordsets

Mini cordsets come in a variety of configurations – 2 to 19 pins/poles, single or double-ended, straight or 90°, male or female. And are constructed with 16 or 18 AWG cable. Cable jackets include PVC, PUR, TPE, or CPE, wired in accordance with U.S., IEC, Automotive, or Numeric color codes.

Features:

- 2 to 19 pins/poles
- Oil resistant outer jacket and C-Track and Welding Applications supported
- High-flex conductor stranding
- Patented ratchet nut, prevents loosening when vibration is encountered
- Accepted industry standard design
- UL/CSA approvals
- IP 68 rated (Enclosure~Less)



Receptacles

Mini receptacles come in a variety of configurations – 2 to 12 and 19 pins/poles, male or female, front or rear mount and are wired in accordance with U.S., IEC, Automotive, or Numeric color codes.

Features:

- 2 to 12 and 19 pins/poles
- Vibration and shock resistant
- Accepted industry standard design
- UL/CSA approvals
- IP 68 rated (Enclosure~Less)

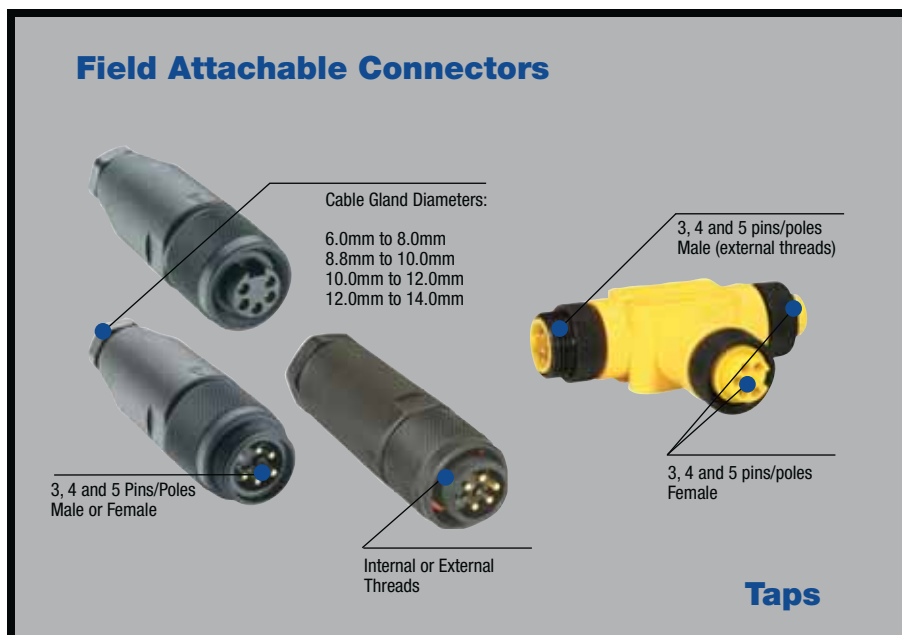
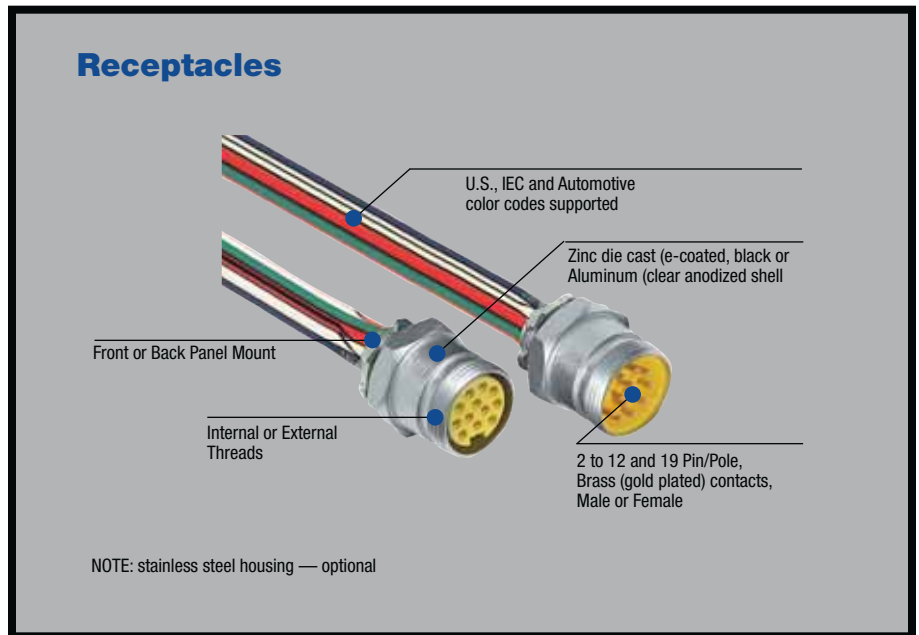

Field Attachable Connectors

Mini field attachable connectors are designed to complete the assembly of a single-ended cordset or to be used with raw cable.

Available in male (internal or external threads) and female versions, these 3, 4 and 5 pin/pole connectors contain screw terminals for quick and easy assembly of custom cables used on the plant floor or on existing machines.

Accessories

Accessories to the Mini line of connectors include Auxiliary Power Taps (3, 4 and 5 pins/poles), and Dust Covers (male or female) for unused ports.

Connectivity Overview - M12 Series

Distribution Boxes

Micro (M12) distribution boxes (stainless steel version shown) simplify control wiring while eliminating long cable runs and are ideally suited for harsh industrial environments.

Distribution boxes are equipped with plug-n-play side or top mount quick-disconnect ports and on-board quick-disconnect (M23), integrated home run control cable with Mini style connector or open leads.

Features:

- Ports: 4, 6, or 8 ports
- Housing Types: TPU, self-extinguishing or Stainless Steel
- Inserts: PA GF, self-extinguishing or PVC
- Contacts: Brass, pre-nickel and 0.8 microns gold plated
- LED: with or without
- IP Ratings: from IP 67 to IP 69K
- UL/CSA approvals

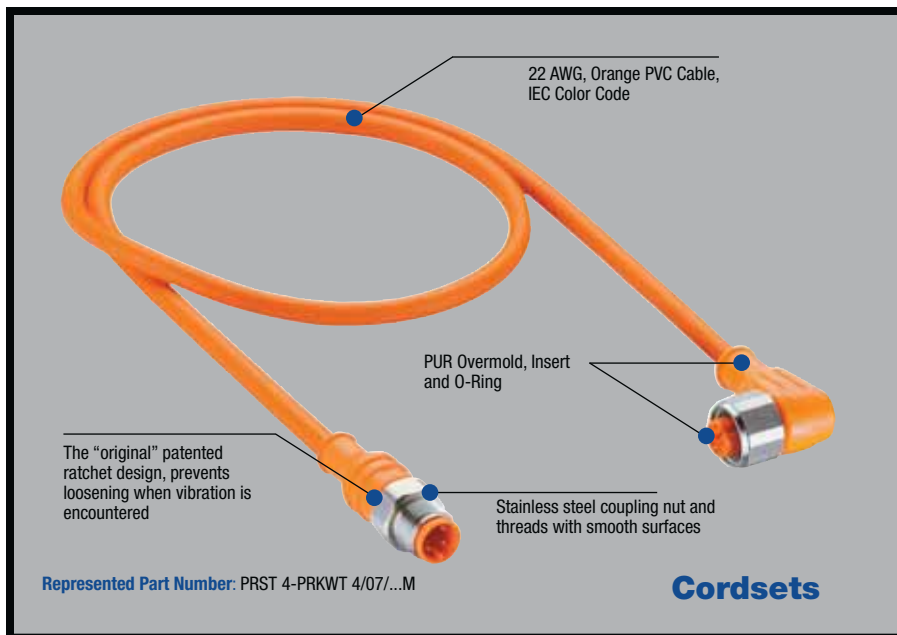
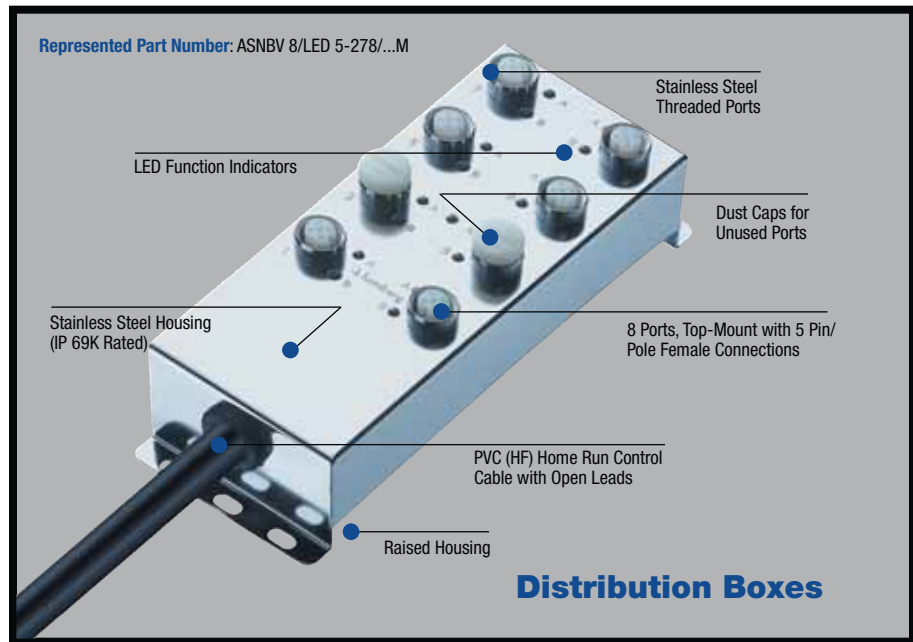

Cordsets

M12 (Micro) cordsets come in variety of configurations, single or double-ended, straight or 90°, male or female. Cable gauges include 18, 22, 24, or 26 AWG with TPE, PVC (standard or shielded), PUR Halogen Free (standard, welding spark proof or shielded) jackets and accommodate IEC (DC) and U.S. or Automotive (AC) color codes.

Features:

- Pins/Poles: 3, 4, 5, 6, 8, or 12 pins/poles
- LED Function Indicators: with or without
- Jacket Material: Oil resistant outer jacket and C-Track and Welding Applications supported
- Shielding: with or without
- Patented ratchet nut, prevents loosening when vibration is encountered
- Accepted industry standard design
- UL/CSA approvals
- IP 67/68 rated (Enclosure~Less)



“Y” and “T” Splitters

The Micro M12 (DC and AC) “Y” and “T” splitters are used to bring two sensor signals into a single port of a distribution box (two signals per port); thereby doubling the boxes capacity. Splitters come in a variety of wiring configurations, cable types and body styles.

Features:

- “Y” Configurations: Male Straight to Two Female Straight or 90° or “T” Male Straight to Two Female Straight
- Vibration and shock resistant
- Accepted industry standard design
- IP 68 rated (Enclosure~Less)

Receptacles

Micro M12 receptacles come in a variety of configurations – 2 to 12 and 19 pins/poles, male or female, front or rear mount and are wired in accordance with U.S., IEC, Automotive, or Numeric color codes.

Features:

- 2 to 12 and 19 pins/poles
- Vibration and shock resistant
- Accepted industry standard design
- UL/CSA approvals
- IP 68 rated (Enclosure~Less)

“Y” Splitter

Represented Part Number: ASB 2-RKWT/LED A 4-3-224/...M

PUR, Halogen Free Cable (IEC Color Code)

Two Female, 90°, 3 Pin/Pole Brass, pre-nickel and 0.3 microns gold-plated

“T” Splitter

Represented Part Number: ASBS 2 M12-5

TPU, Overmolded Body

Male 3 Pin/Pole Brass, pre-nickel and 0.8 microns gold-plated contacts

TPU, Molded Body

Male 5 Pin/Pole Brass, pre-nickel and 0.8 microns gold-plated contacts

Two Female, Straight, 5 Pin/Pole Brass, pre-nickel and 0.3 microns gold-plated

Receptacles

4, 5, or 8 wire leads - male or female contacts

Stainless steel potted housing

Hexagon nut with smooth surface

Stainless steel housing, front mount with solder contacts - especially for use on food processing equipment

Represented Part Numbers:
PRKFM/...M, PRSFM...M and PRSFM

Field Attachables

Cable Diameter Range
3.0 mm to 6.5 mm
4.0 mm - 8.0 mm

3, 4, 5, or 8 Pin/Pole
Female or Male

Represented Part Numbers:
RSCW 4/7, RKC 4/7, RSC 4/7 and RKCW 4/7

Connectivity Overview - M8 Series

Distribution Boxes

Pico (M8) distribution boxes simplify wiring while eliminating long cable runs and are ideally suited for harsh industrial environments.

Distribution boxes are equipped with top mount quick-disconnect ports, on-board M12 quick-disconnect, or integrated home run control cable with open leads.

Features:

- Ports: 4, 6, or 8 ports
- Housing Types: PBT and TPU self-extinguishing
- Inserts: PA and TPU self-extinguishing
- Contacts: M8: CuSn, pre-nickel and 0.8 microns gold plated and M12: CuZn, pre-nickel and 0.8 microns gold plated
- LED: yes
- IP Ratings: IP 67

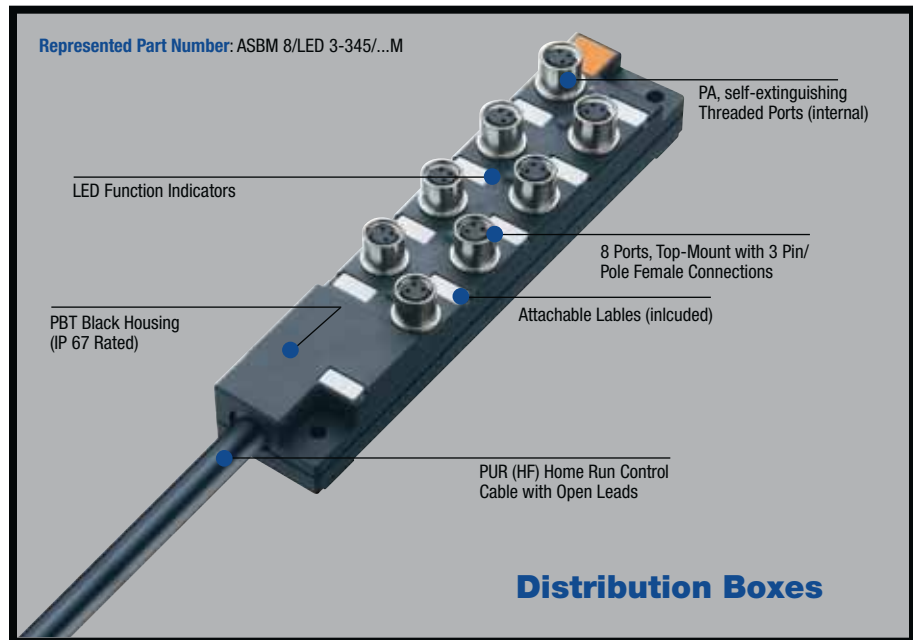

Cordsets

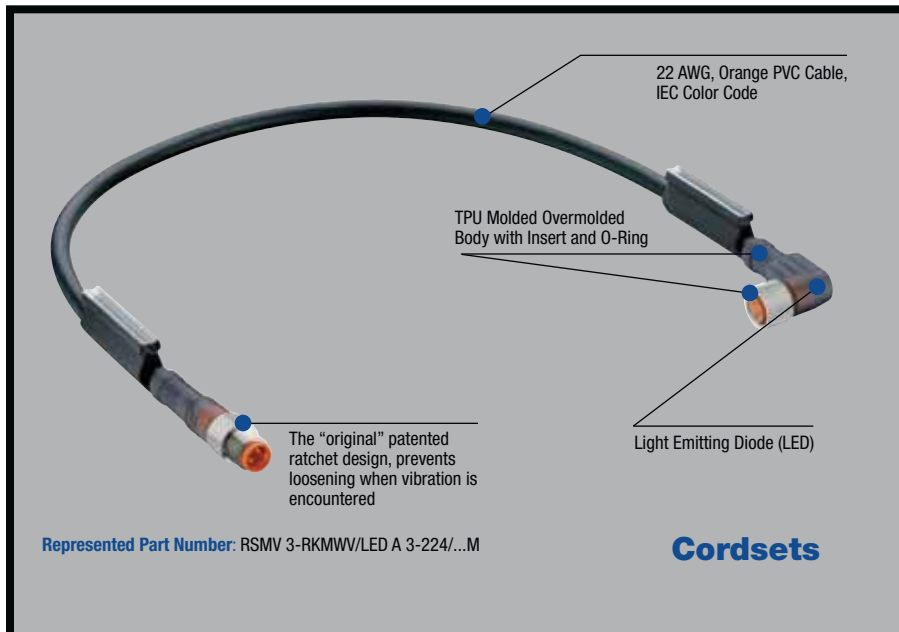

M8 (Pico) cordsets come in variety of configurations, single and double-ended, straight and 90°, male and female. Cable gauges include 22 or 24 AWG with PVC or PUR halogen-free jackets and accommodate the IEC color code.

Features:

- Pins/Poles: 3, 4, and 8 pins/poles
- LED Function Indicators (double-ended only): with or without
- Jacket Material: Oil resistant, shock and vibration proof, and C-Track rated
- Patented ratchet nut, prevents loosening when vibration is encountered
- Accepted industry standard design
- UL approvals
- IP 67/68 rated (Enclosure~Less)



“Y” and “T” Splitters

The Pico (M8) “Y” and “T” splitters are used to bring two sensor signals into a single port of a distribution box (two signals per port); thereby doubling the boxes capacity. Splitters come in a variety of wiring configurations, cable types and body styles.

Features:

- “Y” Configurations: Male Straight to Two Female Straight or 90° or “T” Male Straight to Two Female Straight
- Vibration and shock resistant
- Accepted industry standard design
- IP 67 rated

Receptacles

Pico M8 receptacles come in a variety of configurations – 3, 4, and 8 pins/poles, male or female, front or rear mount and are wired in accordance with IEC color codes.

Features:

- 3, 4, and 8 pins/poles
- Vibration and shock resistant
- Accepted industry standard design
- UL/CSA approvals
- IP 67 rated

“Y” Splitter

PUR, Halogen Free Cable (IEC Color Code)

Two M8 Female, 90°, 3 Pin/Pole Brass, pre-nickel and 0.3 microns gold-plated

TPU, Overmolded Body

M12 Male 3 Pin/Pole Brass, pre-nickel and 0.8 microns gold-plated contacts

“T” Splitter

TPU, Molded Body

M12 Male 4 Pin/Pole Brass, pre-nickel and 0.8 microns gold-plated contacts

Two M8 Female, Straight, 3 Pin/Pole Brass, pre-nickel and 0.3 microns gold-plated with self-locking joint.

Represented Part Number: ASBA 2-RKT 4-3-224/...M

Represented Part Number: ASBS 2 M8

Receptacles

3, 4, or 8 wire leads - male or female contacts

Hexagon Nut for Rear Mount

Solder CuZn Contacts Potted with Epoxy

CuZn, Nickel-Plated

TPU, Self-Extinguishing Insert

PCB Contacts

Represented Part Numbers:
RSMF/0.5 M... RKMf/0.5M... RKMHL/S 5.5

Field Attachables

CuZn, Nickel-Plated

3 and 4 Pin/Pole Male or Female

PBT Housing

Represented Part Numbers:
RSMC...RSMCW...RSMCK...RKMCK...RKMCKW...RKMCK

M8 Actuator/Sensor Distribution Boxes

ASBSM.../LED



4-, 6-, 8-, and 10-Ports (LED)

Pluggable miniature actuator/sensor distribution box with LED operation and function indicators, top-entry, 4-10-ports, M8 socket, 3-poles, 1 signal per socket, M12 connection for the control cable.

– control cable type: RKT12-348/...M or RKWT 12-348/...M –

4-Ports

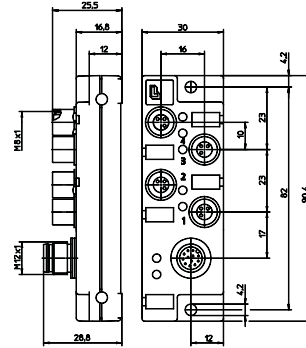

Pin Assignments

M8 / M12

Wiring Diagrams

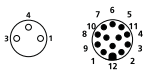

4-Ports

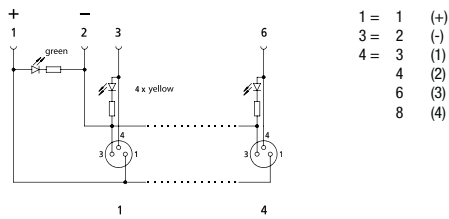

6-Ports

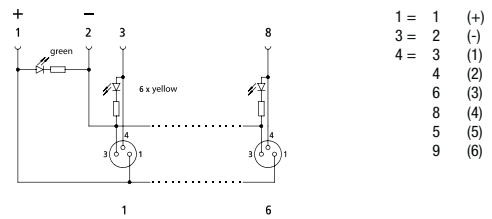

8-Ports

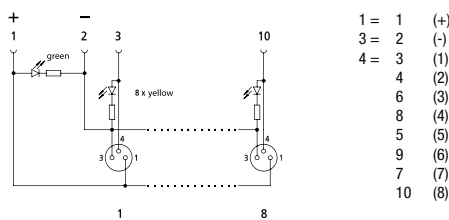

10-Ports

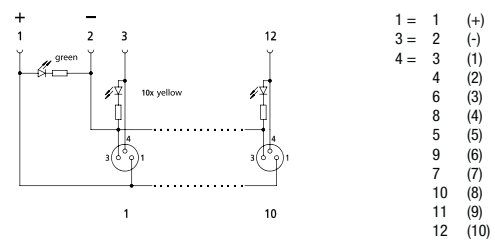



Be Certain with Belden

M8 Actuator/Sensor Distribution Boxes

ASBSM 4/LED 3 | ASBSM 6/LED 3 | ASBSM 8/LED 3 | ASBSM 10/LED 3

6-Ports

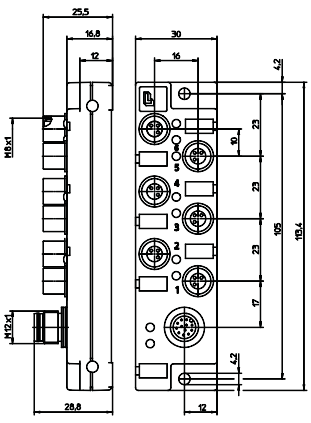

8-Ports

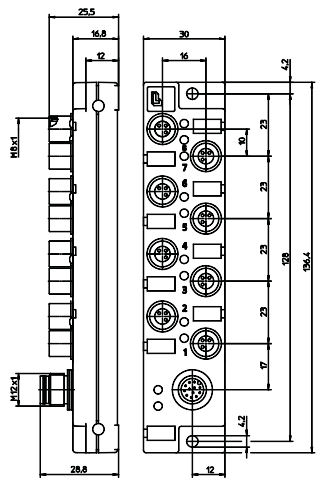

10-Ports

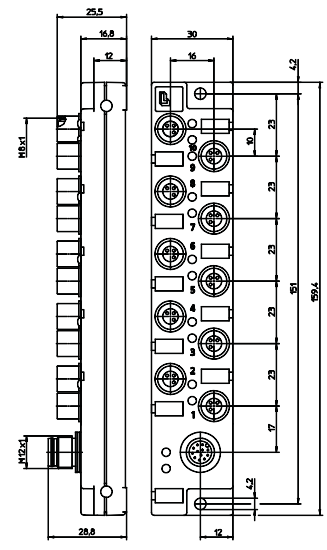

Technical Data

Environmental

Degree of protection
Operating temperature range

IP 67 / NEMA 6P
-25°C (-13°F) / +70°C (+158°F)

Mechanical

Housing
Insert
Contact

PBT
PA, self-extinguishing
M8: CuSn, pre-nickelated and 0.8 microns gold-plated
M12: Brass, pre-nickelated and 0.8 microns gold-plated
Brass, nickel-plated
FKM

Receptacle shell
O-ring

Electrical

Contact resistance
Voltage rating
Current rating

≤5mΩ
10-30 V DC
1.5 A per port
1.5 A max. total

Accessories (included)

ZVKM
ZBR 5/10

2 M8 dust covers for unused sockets
Attachable labels:
4-Ports: 5 pieces
6- and 8-Ports: 10 pieces
10-Ports: 15 pieces

Part Number	Ports	Mating Cordsets	Mating Control Cable	Characteristics
ASBSM 4/LED 3	4	RSMV 3... or RSMWV 3...	RKT 12-348 or RKWT 12-348	
ASBSM 6/LED 3	6	RSMV 3... or RSMWV 3...	RKT 12-348 or RKWT 12-348	
ASBSM 8/LED 3	8	RSMV 3... or RSMWV 3...	RKT 12-348 or RKWT 12-348	
ASBSM 10/LED 3	10	RSMV 3... or RSMWV 3...	RKT 12-348 or RKWT 12-348	

M8 Actuator/Sensor Distribution Boxes

ASBM .../LED



4-, 6-, 8-, 10- and 12-Ports (LED)

Pluggable miniature actuator/sensor distribution box with LED operation and function indicators, top-entry, 4-12-ports, M8 socket, 3-poles, 1 signal per socket, with integrated control cable.

6-Ports

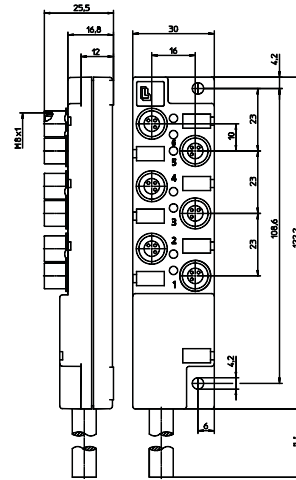

4-Ports

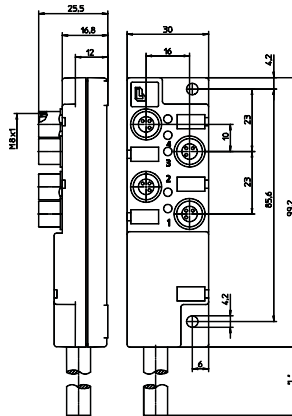

Pin Assignments

M8

Wiring Diagrams



4-Ports

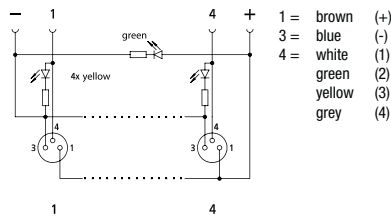

6-Ports

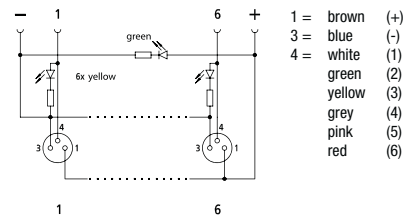

8-Ports

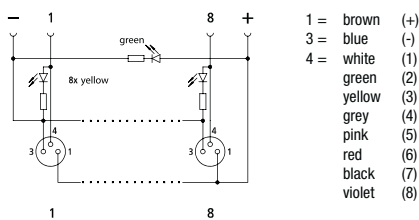

10-Ports

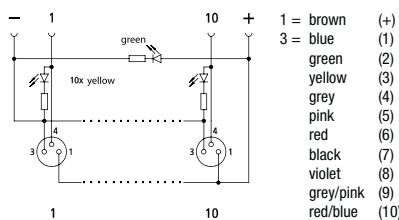

12-Ports

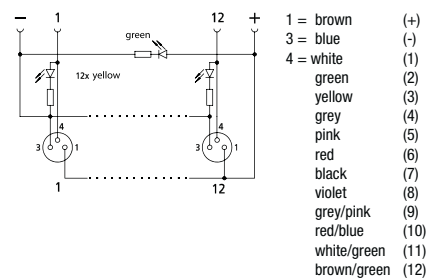



Be Certain with Belden

Distribution Boxes

M8 Actuator/Sensor Distribution Boxes

ASBM 4/LED 3-343 | ASBM 6/LED 3-344 | ASBM 8/LED 3-345 | ASBM 10/LED 3-346 | ASBM 12/LED 3-347

8-Ports

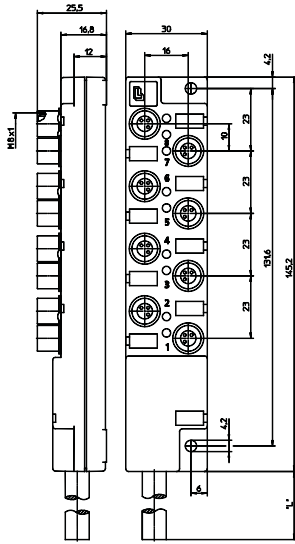

10-Ports

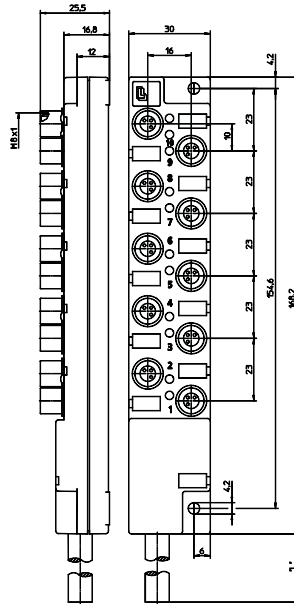

12-Ports

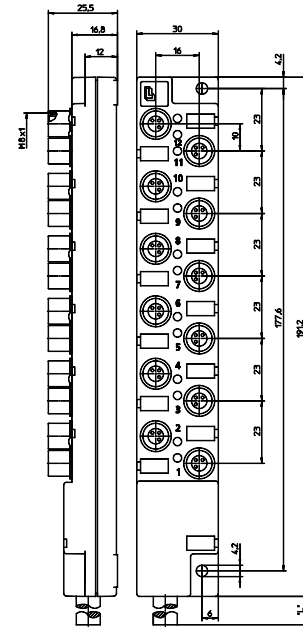

Technical Data

Environmental

Degree of protection
Operating temperature range

IP 67 / NEMA 6P
-25°C (-13°F) / +70°C (+158°F)

Mechanical

Housing
Insert
Contact

PBT
PA, self-extinguishing
CuSn, pre-nickelated and 0.8 microns gold-plated
Brass, nickel-plated
FKM

Receptacle shell
O-ring

Electrical

Contact resistance
Voltage rating
Current rating

≤5mΩ
10-30 V DC
1.5 A per port
1.5 A max. total

Accessories (included)

ZVKM
ZBR 5/10

2 M8 dust covers for unused sockets
Attachable labels:
4-Ports: 5 pieces
6- and 8-Ports: 10 pieces
10- and 12-Ports: 15 pieces

Cable Specifications

Cable No.	Outer Jacket	Conductor Size	Jacket Color	OD
343	PUR, halogen-free	6 x 0.25 mm ²	Black	.201" (5.1 mm)
344	PUR, halogen-free	8 x 0.25 mm ²	Black	.236" (6.0 mm)
345	PUR, halogen-free	10 x 0.25 mm ²	Black	.248" (6.3 mm)
346	PUR, halogen-free	12 x 0.25 mm ²	Black	.252" (6.4 mm)
347	PUR, halogen-free	14 x 0.25 mm ²	Black	.284" (7.2 mm)

Part Number	Ports	Standard Cable Lengths	Mating Cordsets	Characteristics
ASBM 4/LED 3-343/...M	4	5M, 10M, 15M	RSMV 3... or RSMWV 3...	
ASBM 6/LED 3-344/...M	6	5M, 10M, 15M	RSMV 3... or RSMWV 3...	
ASBM 8/LED 3-345/...M	8	5M, 10M, 15M	RSMV 3... or RSMWV 3...	
ASBM 10/LED 3-346/...M	10	5M, 10M, 15M	RSMV 3... or RSMWV 3...	
ASBM 12/LED 3-347/...M	12	5M, 10M, 15M	RSMV 3... or RSMWV 3...	

M8 Actuator/Sensor Distribution Boxes

SBS 4/LED 3



4-Ports (LED)

Pluggable miniature actuator/sensor distribution box with LED operation and function indicators, top-entry, 4-ports, M8 socket, 3-poles, 1 signal per socket, M12 connection for the control cable.

– control cable type: RKT 8-6-337 or RKWT 8-6-337 –

4-Ports

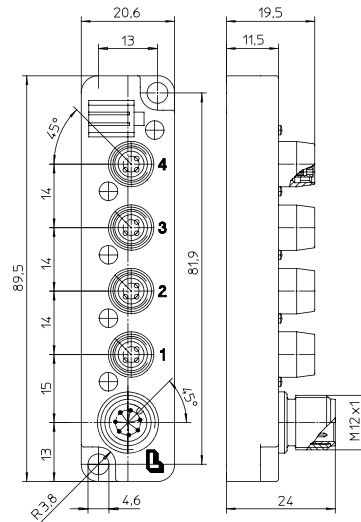

Pin Assignments

M8 / M12

Wiring Diagrams

4-Ports

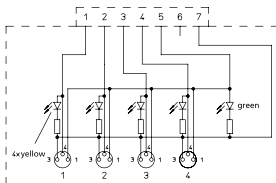
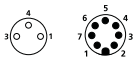

- 1 = 5 (+)
- 3 = 7 (-)
- 4 = 1 (1)
- 2 = 2 (2)
- 3 = 3 (3)
- 4 = 4 (4)



Be Certain with Belden

M8 Actuator/Sensor Distribution Boxes

SBS 4/LED 3

Technical Data

Environmental

Degree of protection IP 67 / NEMA 6P
 Operating temperature range -15°C (+5°F) / +90°C (+194°F)

Mechanical



Housing TPU, self-extinguishing
 Insert **M8:** TPU, self-extinguishing
M12: PA
 Contact CuSn, pre-nickel and 0.8 microns gold-plated
 Receptacle shell Brass, nickel-plated
 O-ring FKM

Electrical

Contact resistance $\leq 5m\Omega$
 Voltage rating 10-30 V DC
 Current rating 2 A per port / 2 A max. total

Accessories (included)

ZVKM 2 dust covers for unused sockets
 1 attachable label

Part Number	Ports	Mating Cordsets	Mating Control Cable	Characteristics
SBS 4/LED 3	4	RSMV 3... or RSMWV 3...	RKT 8-6-337 or RKWT 8-6-337	 

M8 Actuator/Sensor Distribution Boxes

SB 8/LED 3



8-Ports (LED)

Pluggable miniature actuator/sensor distribution box with LED operation and function indicators, top-entry, 8-ports, M8 socket, 3-poles, 1 signal per socket with integrated control cable.

8-Ports

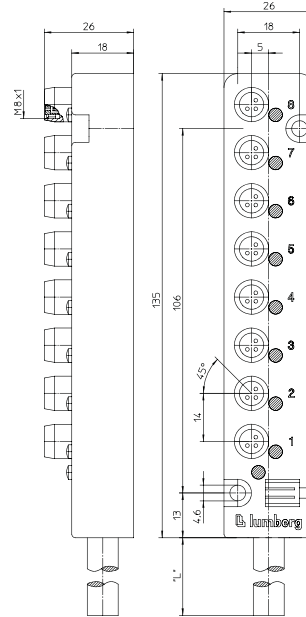

Pin Assignments

M8

Wiring Diagrams

4-Ports

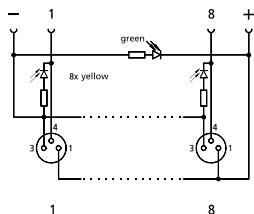

- 1 = brown (+)
- 3 = blue (-)
- 4 = white (1)
- green (2)
- yellow (3)
- grey (4)
- pink (5)
- red (6)
- black (7)
- violet (8)



Be Certain with Belden

M8 Actuator/Sensor Distribution Boxes SB 8/LED 3-333

Technical Data

Environmental

Degree of protection IP 67 / NEMA 6P
 Operating temperature range -15°C (+5°F) / +80°C (+176°F)

Mechanical

Housing PBT
 Insert TPU, self-extinguishing
 Contact CuSn, pre-nickelated and 0.8 microns gold-plated
 Receptacle shell Brass, nickel-plated
 O-ring FKM

Electrical



Contact resistance $\leq 5m\Omega$
 Voltage rating 10-30 V DC
 Current rating 2 A per port / 2 A max. total

Accessories (included)

ZVKM 2 M8 dust covers for unused sockets
 ZBR 5/10 Attachable labels:
 10 pieces

Cable Specifications

Cable No.	Outer Jacket	Conductor Size	Jacket Color	OD
333	PUR, halogen-free	2 x 0.50 mm ² 8 x 0.34 mm ²	Black	.347" (8.8 mm)

Part Number	Ports	Standard Cable Lengths	Mating Cordsets	Characteristics
SB 8/LED 3-333/...M	8	5M, and 10M	RSMV 3... or RSMWV 3...	  

M12 Actuator/Sensor Distribution Boxes (Stainless Steel)

ASNBV 8/LED



8-Ports (Stainless Steel Housing)

Actuator/sensor distribution box with LED operation and function indicators, housing and receptacle shells in stainless steel, top-entry, 8-ports, M12 sockets, 5-poles, 2 signals per socket, with integrated control cable.

– especially designed for use in food processing equipment applications –

8-Ports

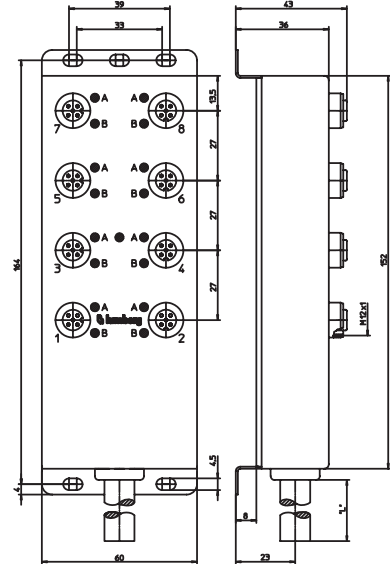

Pin Assignments

M12

Wiring Diagrams

8-Ports

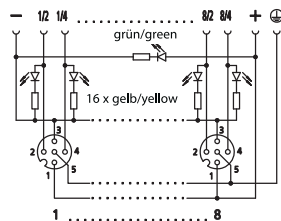

- | | |
|-------------------|-----------------------|
| 1 = Brown (+) | 4 = White (1) |
| 2 = Gray/Pink (1) | Green (2) |
| Red/Blue (2) | Yellow (3) |
| White/Green (3) | Grey (4) |
| Brown/Green (4) | Pink (5) |
| White/Yellow (5) | Red (6) |
| Yellow/Brown (6) | Black (7) |
| White/Grey (7) | Violet (8) |
| Grey/Brown (8) | 5 = Green/Yellow (PE) |
| 3 = Blue (-) | |



Be Certain with Belden

M12 Actuator/Sensor Distribution Boxes (Stainless Steel) ASNBV 8/LED

Technical Data

Environmental

Degree of protection IP 67 / IP 69 K
 Operating temperature range -25°C (-13°F) / +70°C (+158°F)

Mechanical

Housing Stainless steel
 Housing back cover PVC
 Insert PVC
 Contact CuSn, gold over nickel plated
 Receptacle shell Stainless steel
 O-ring EPDM

Electrical





Contact resistance $\leq 5 \text{ m}\Omega$
 Voltage rating 10-30 V DC
 Current rating 4A per port, 12A max. total
 Insulation resistance $> 10^9 \Omega$

Accessories (included)

PZVK 4 PVC dust covers for unused sockets

Cable Specifications

Cable No.	Outer Jacket	Conductor Size	Jacket Color	OD
278	PVC	16 x 0.50 mm ² 3 x 1.00 mm ²	Black	.457" (11.6 mm)

Part Number	Ports	Standard Cable Lengths	Mating Cordsets	Characteristics
ASNBV 8/LED 5-278/...M	8	5M, 10M, 15M	PRST-PRKT, PRST-PRKWT, PRST-PRKWT/LED	    

M12 Actuator/Sensor Distribution Boxes (Stainless Steel)

ASNBL 8/LED



8-Ports (Stainless Steel Housing)

Actuator/sensor distribution box with LED operation and function indicators, housing and receptacle shells in stainless steel, side-entry, 8-ports, M12 sockets, 5-poles, 1 signal per socket, with integrated control cable.

– especially designed for use in food processing equipment applications –

8-Ports

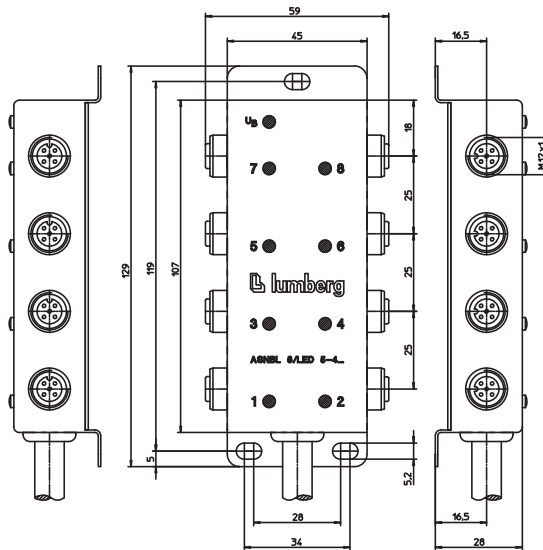

Pin Assignments

M12

Wiring Diagrams

8-Ports

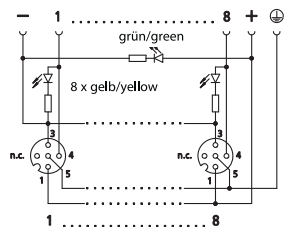

- | | | | |
|-----------|-----|------------------|------|
| 1 = Brown | (+) | Grey | (4) |
| 2 = n.c. | | Pink | (5) |
| 3 = Blue | (-) | Red | (6) |
| 4 = White | (1) | Black | (7) |
| Green | (2) | Violet | (8) |
| Yellow | (3) | 5 = Green/Yellow | (PE) |



Be Certain with Belden

M12 Actuator/Sensor Distribution Boxes (Stainless Steel) ASNBL 8/LED

Technical Data

Environmental

Degree of protection IP 67 / IP 69 K
 Operating temperature range -25°C (-13°F) / +70°C (+158°F)

Mechanical

Housing Stainless steel
 Housing back cover PVC
 Insert PVC
 Contact CuSn, gold over nickel plated
 Receptacle shell Stainless steel
 O-ring EPDM

Electrical





Contact resistance ≤ 5 mΩ
 Voltage rating 10-30 V DC
 Current rating 4A per port, 12A max. total
 Insulation resistance > 10⁹ Ω

Accessories (included)

PZVK 4 PVC dust covers for unused sockets

Cable Specifications

Cable No.	Outer Jacket	Conductor Size	Jacket Color	OD
320	PVC	8 x 0.34 mm ² 3 x 0.75 mm ²	Black	.374" (9.5 mm)

Part Number	Ports	Standard Cable Lengths	Mating Cordsets	Characteristics
ASNBL 8/LED 5-4-320/...M	8	5M, 10M, 15M	PRST-PRKT, PRST-PRKWT, PRST-PRKWT/LED	    

M12 Actuator/Sensor Distribution Boxes

ASB 4 | ASB 6 | ASB 8



4-, 6-, and 8-Ports

Actuator/sensor distribution box, top-entry, 4-, 6-, and 8-ports, M12 sockets, 4-poles, 1 signal per socket, with integrated control cable.

– control cable is suitable for c-track applications –

4-Ports

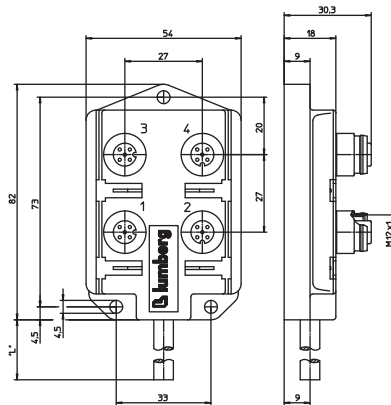

6-Ports

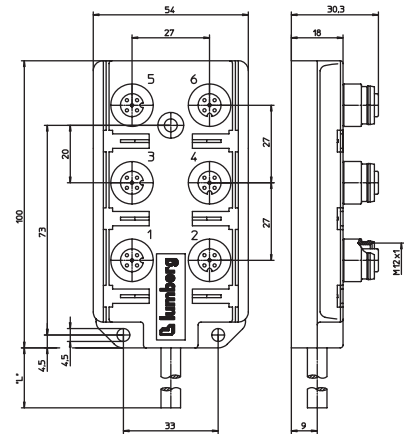

Pin Assignments

M12

Wiring Diagrams



4-Ports

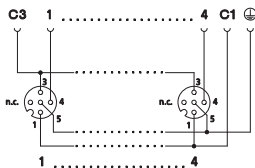

- 1 = brown (C1)
- 2 = n.c.
- 3 = blue (C3)
- 4 = white (1)
- green (2)
- yellow (3)
- grey (4)
- 5 = green/yellow (PE)

6-Ports

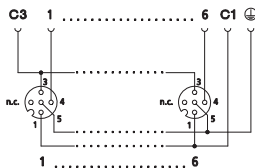

- 1 = brown (C1)
- 2 = n.c.
- 3 = blue (C3)
- 4 = white (1)
- green (2)
- yellow (3)
- grey (4)
- pink (5)
- red (6)
- 5 = green/yellow (PE)

8-Ports

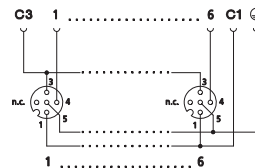

- 1 = brown (C1)
- 2 = n.c.
- 3 = blue (C3)
- 4 = white (1)
- green (2)
- yellow (3)
- grey (4)
- pink (5)
- red (6)
- black (7)
- violet (8)
- 5 = green/yellow (PE)



Be Certain with Belden

M12 Actuator/Sensor Distribution Boxes
 ASB 4 5-4-328 | ASB 6 5-4-330 | ASB 8 5-4-331

8-Ports

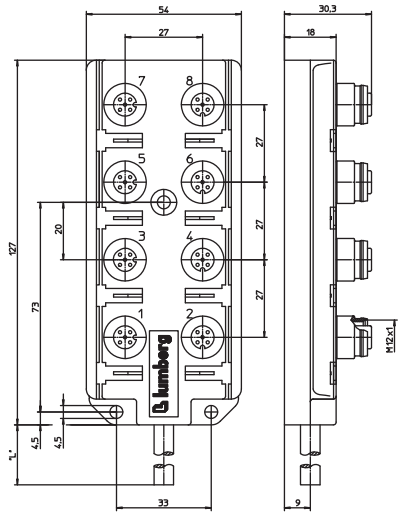

Technical Data

Environmental

Degree of protection IP 67 / NEMA 6P
 Operating temperature range -15°C (+5°F) / +80°C (+176°F)

Mechanical

Housing TPU, self-extinguishing
 Insert PA GF, self-extinguishing
 Contact CuZn, pre-nickelated and 0.8 microns gold-plated
 Receptacle shell CuZn, nickel-plated
 O-ring FKM

Electrical

Contact resistance ≤5mΩ
 Voltage rating 250 V
 Current rating 4 A per port / 12 A max. total
 Insulation resistance > 10⁹ Ω

Accessories (included)

ZVK 2 dust covers for unused sockets
 ZBS 10 attachable labels

Cable Specifications

Cable No.	Outer Jacket	Conductor Size	Color	Outside Diameter
328	PUR, halogen-free	3 x 0.75 mm ² 4 x 0.34 mm ²	Black	.268" (6.8 mm)
330	PUR, halogen-free	3 x 0.75 mm ² 6 x 0.34 mm ²	Black	.299" (7.6 mm)
331	PUR, halogen-free	3 x 0.75 mm ² 8 x 0.34 mm ²	Black	.315" (8.0 mm)

Part Number	Ports	Standard Cable Length	Characteristics
ASB 4 5-4-328/...M	4	5M and 10M	
ASB 6 5-4-330/...M	6	5M and 10M	
ASB 8 5-4-331/...M	8	5M and 10M	

M12 Actuator/Sensor Distribution Boxes

ASB 4/LED | ASB 6/LED | ASB 8/LED



4-, 6-, and 8-Ports (LED)

Actuator/sensor distribution box with LED operation and function indicators, top-entry, 4-, 6-, and 8-ports, M12 sockets, 4-poles, 1 signal per socket, with integrated control cable.

– control cable is suitable for c-track applications –

4-Ports

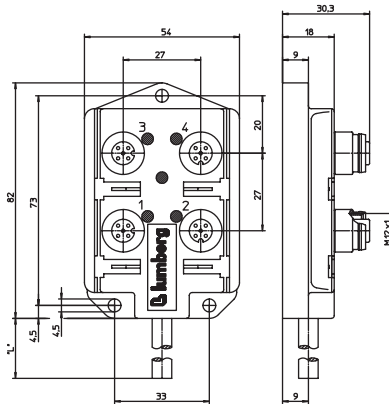

6-Ports

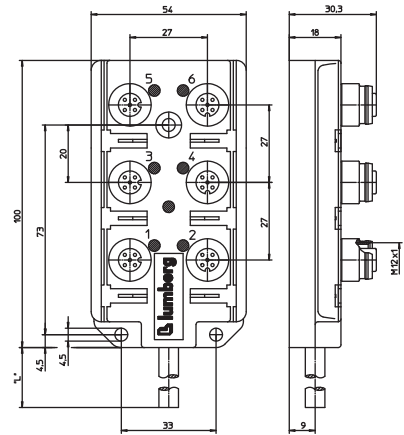

Pin Assignments

M12 Wiring Diagrams



4-Ports

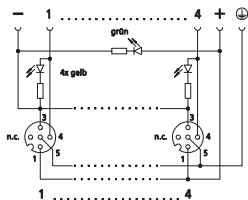

- 1 = brown (C1)
- 2 = n.c.
- 3 = blue (C3)
- 4 = white (1)
- green (2)
- yellow (3)
- grey (4)
- 5 = green/yellow (PE)

6-Ports

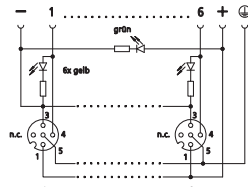

- 1 = brown (C1)
- 2 = n.c.
- 3 = blue (C3)
- 4 = white (1)
- green (2)
- yellow (3)
- grey (4)
- pink (5)
- red (6)
- 5 = green/yellow (PE)

8-Ports

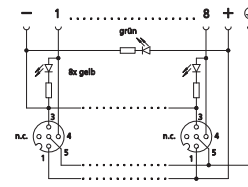

- 1 = brown (C1)
- 2 = n.c.
- 3 = blue (C3)
- 4 = white (1)
- green (2)
- yellow (3)
- grey (4)
- pink (5)
- red (6)
- black (7)
- violet (8)
- 5 = green/yellow (PE)



Be Certain with Belden

M12 Actuator/Sensor Distribution Boxes

ASB 4/LED 5-4-328 | ASB 6/LED 5-4-330 | ASB/LED 8 5-4-331

8-Ports

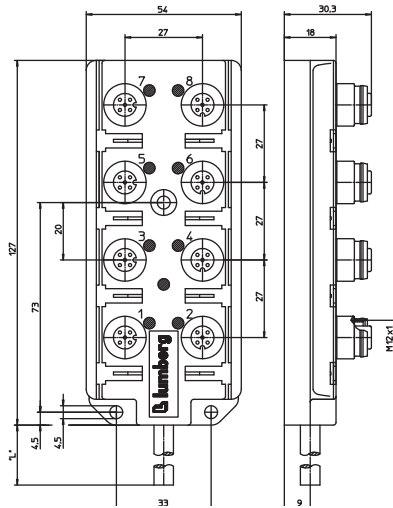

Technical Data

Environmental

Degree of protection IP 67 / NEMA 6P
 Operating temperature range -15°C (+5°F) / +80°C (+176°F)

Mechanical

Housing TPU, self-extinguishing
 Insert PA GF, self-extinguishing
 Contact CuZn, pre-nickel and 0.8 microns gold-plated
 Receptacle shell CuZn, nickel-plated
 O-ring FKM

Electrical

Contact resistance ≤5mΩ
 Voltage rating 10-30 V DC
 Current rating 4 A per port / 12 A max. total
 Insulation resistance > 10⁹ Ω

Accessories (included)

ZVK 2 dust covers for unused sockets
 ZBS 10 attachable labels

Cable Specifications

Cable No.	Outer Jacket	Conductor Size	Color	Outside Diameter
328	PUR, halogen-free	3 x 0.75 mm ² 4x 0.34 mm ²	Black	.268" (6.8 mm)
330	PUR, halogen-free	3 x 0.75 mm ² 6x 0.34 mm ²	Black	.299" (7.6 mm)
331	PUR, halogen-free	3 x 0.75 mm ² 8 x 0.34 mm ²	Black	.315" (8.0 mm)

Part Number	Ports	Standard Cable Length	Characteristics
ASB 4/LED 5-4-328/...M	4	5M and 10M	
ASB 6/LED 5-4-330/...M	6	5M and 10M	
ASB 8/LED 5-4-331/...M	8	5M and 10M	

M12 Actuator/Sensor Distribution Boxes

ASB 4/LED - RS120M | ASB 8/LED - RS120M



4- and 8-Ports (LED)

Actuator/sensor distribution box with LED operation and function indicators, top-entry, 4- and 8-ports, M12 sockets, 4-poles, 1 signal per socket, with integrated Mini quick disconnect home run control cable.

– control cable is suitable for c-track applications –

4-Ports

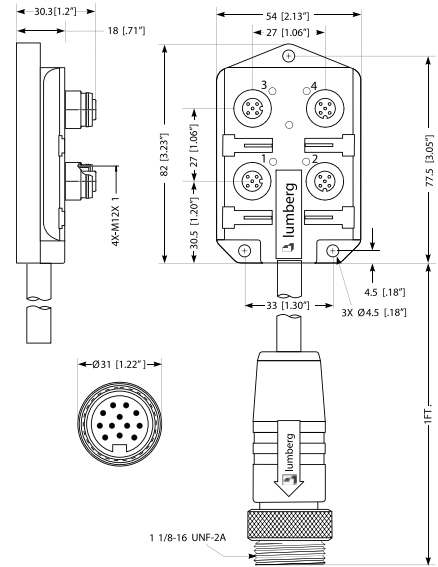

Pin Assignments

M12 / Mini 1 1/8"

Wiring Diagrams

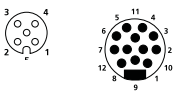

4-Ports

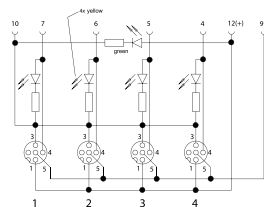

- 1 = 12 (+)
- 3 = 10 (-)
- 4 = 1 (7)
- 2 = 2 (6)
- 3 = 3 (5)
- 4 = 4 (4)
- 5 = 9 (gnd)

8-Ports

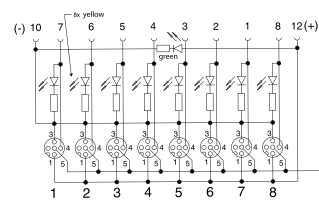

- 1 = 12 (+)
- 3 = 10 (-)
- 4 = 1 (7)
- 2 = 2 (6)
- 3 = 3 (5)
- 4 = 4 (4)
- 5 = 5 (3)
- 6 = 6 (2)
- 7 = 7 (1)
- 8 = 8 (8)
- 5 = 9 (gnd)



Be Certain with Belden

M12 Actuator/Sensor Distribution Boxes
 ASB 4/LED 5-4-328/RS120M | ASB/LED 8 5-4-331/RS120M

8-Ports

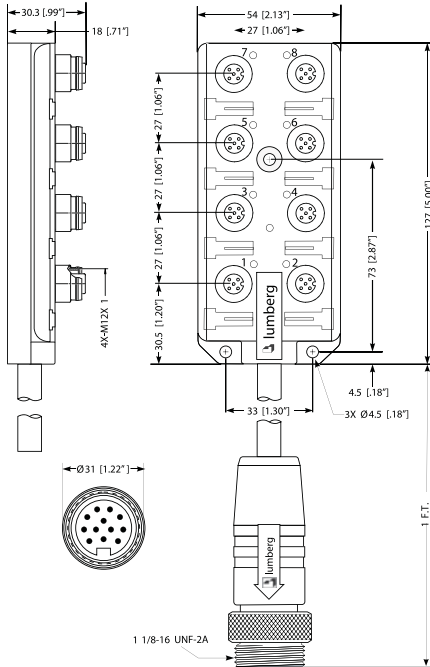

Technical Data

Environmental

Degree of protection IP 67 / NEMA 6P
 Operating temperature range -15°C (+5°F) / +80°C (+176°F)

Mechanical

Housing PUR, yellow
 Insert Nylon
 Contact CuZn, gold plated
 Receptacle shell CuZn, nickel-plated
 O-ring FKM

Mini Quick Disconnect

Molded body PUR, yellow
 Insert PUR, yellow
 Contact CuZn, gold plated
 Coupling nut Aluminum, black anodized

Electrical

Contact resistance $\leq 5m\Omega$
 Voltage rating 10-30 V DC
 Current rating 4 A per port / 12 A max. total
 Insulation resistance $> 10^9 \Omega$

Accessories (included)

ZVK 2 dust covers for unused sockets
 ZBS 10 attachable labels

Cable Specifications

Cable No.	Outer Jacket	Conductor Size	Color	Outside Diameter
328	PUR, halogen-free	3 x 0.75 mm ² 4 x 0.34 mm ²	Black	.268" (6.8 mm)
331	PUR, halogen-free	3 x 0.75 mm ² 8 x 0.34 mm ²	Black	.315" (8.0 mm)

Part Number	Ports	Cable Length	Characteristics
ASB 4/LED 5-4-328/RS120M	4	1F	
ASB 8/LED 5-4-331/RS120M	8	1F	

M12 Actuator/Sensor Distribution Boxes

ASB 8/LED 5-4/1.5M



8-Ports (LED)

Actuator/sensor distribution box with LED operation and function indicators and single wire connection in rear, top-entry, 8-ports, M12 sockets, 4-poles, 1 signal per socket.

– excellent solution for panel-mount applications –

8-Ports

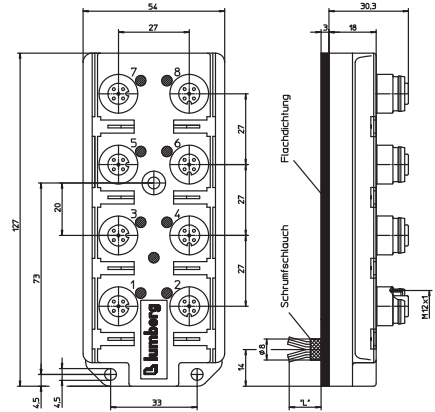

Pin Assignments

M12 Wiring Diagrams



8-Ports

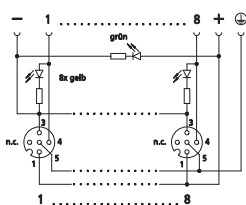

- 1 = brown (C1)
- 2 = n.c.
- 3 = blue (C3)
- 4 = white (1)
- green (2)
- yellow (3)
- grey (4)
- pink (5)
- red (6)
- black (7)
- violet (8)
- 5 = green/yellow (PE)



Be Certain with Belden

M12 Actuator/Sensor Distribution Boxes

ASB 8/LED 5-4/1.5M

Technical Data

Environmental

Degree of protection IP 67 / NEMA 6P
 Operating temperature range -15°C (+5°F) / +80°C (+176°F)

Mechanical

Housing TPU, self-extinguishing
 Insert PA GF, self-extinguishing
 Contact CuZn, pre-nickel and 0.8 microns gold-plated
 Receptacle shell CuZn, nickel-plated
 O-ring FKM

Electrical

Contact resistance $\leq 5m\Omega$
 Voltage rating 10-30 V DC
 Current rating 4 A per port / 12 A max. total
 Insulation resistance $> 10^9 \Omega$

Accessories (included)

ZVK 2 dust covers for unused sockets
 ZBS 10 attachable labels

Part Number	Ports	Standard Wire Length	Characteristics
ASB 8/LED 5-4/1.5M	8	1.5M	  

M12 Actuator/Sensor Distribution Boxes

ASBV



8-Ports

Actuator/sensor distribution box, top-entry, 4-, 6-, and 8-ports, M12 sockets, 5-poles, 2 signals per socket, with integrated control cable.

– control cable is suitable for c-track applications –

4-Ports

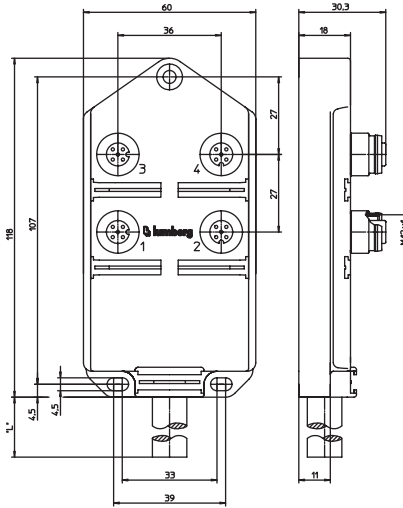

6-Ports

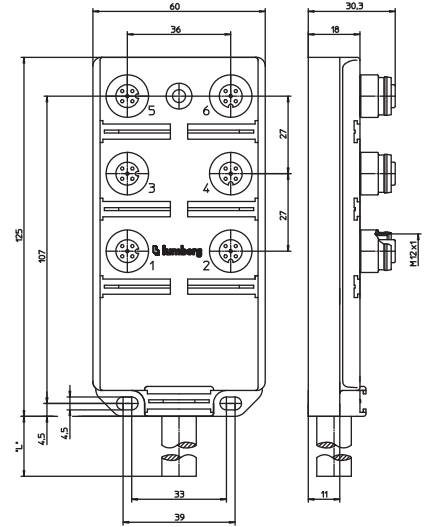

Pin Assignments

M12

Wiring Diagrams



4-Ports

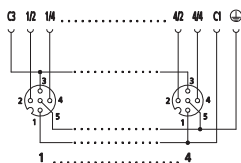

- | | | |
|-----|--------------|------|
| 1 = | brown | (C1) |
| 2 = | grey/pink | (1) |
| | red/blue | (2) |
| | white/green | (3) |
| | brown/green | (4) |
| | blue | (C3) |
| | white | (1) |
| | green | (2) |
| | yellow | (3) |
| | grey | (4) |
| 5 = | green/yellow | (PE) |

6-Ports

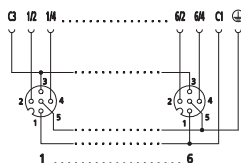

- | | | | | | |
|-----|--------------|------|-----|--------------|------|
| 1 = | brown | (C1) | 4 = | white | (1) |
| 2 = | grey/pink | (1) | | green | (2) |
| | red/blue | (2) | | yellow | (3) |
| | white/green | (3) | | grey | (4) |
| | brown/green | (4) | | pink | (5) |
| | white/yellow | (5) | | red | (6) |
| | yellow/brown | (6) | 5 = | green/yellow | (PE) |
| 3 = | blue | (C3) | | | |

8-Ports

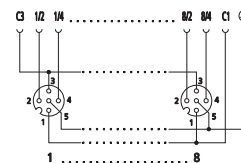

- | | | | | | |
|-----|--------------|------|-----|--------------|------|
| 1 = | brown | (C1) | 3 = | blue | (C3) |
| 2 = | grey/pink | (1) | 4 = | white | (1) |
| | red/blue | (2) | | green | (2) |
| | white/green | (3) | | yellow | (3) |
| | brown/green | (4) | | grey | (4) |
| | white/yellow | (5) | | pink | (5) |
| | yellow/brown | (6) | | red | (6) |
| | white/yellow | (7) | | black | (7) |
| | grey/brown | (8) | | violet | (8) |
| | | | 5 = | green/yellow | (PE) |



Be Certain with Belden

M12 Actuator/Sensor Distribution Boxes

ASBV 4 5-256 | ASBV 6 5-332 | ASBV 8 5-242

8-Ports

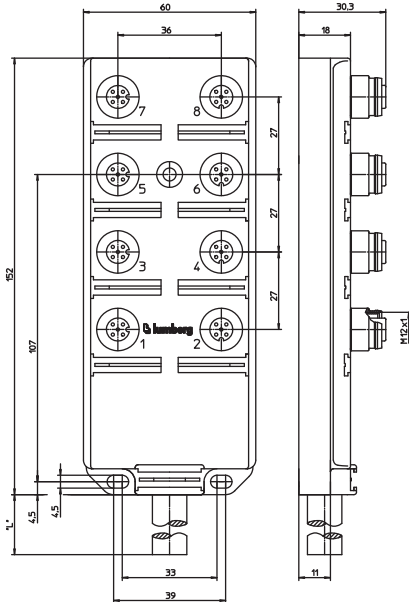

Technical Data

Environmental
 Degree of protection IP 67 / NEMA 6P
 Operating temperature range -15°C (+5°F) / +80°C (+176°F)

Mechanical
 Housing TPU, self-extinguishing
 Insert PA GF, self-extinguishing
 Contact CuZn, pre-nickelated and 0.8 microns gold-plated
 Receptacle shell CuZn, nickel-plated
 O-ring FKM

Electrical
 Contact resistance ≤5mΩ
 Voltage rating 250 V
 Current rating 4 A per port / 12 A max. total
 Insulation resistance > 10⁹ Ω

Accessories (included)
 ZVK 2 dust covers for unused sockets
 ZBS 10 attachable labels

Cable Specifications

Cable No.	Outer Jacket	Conductor Size	Color	Outside Diameter
256	PUR, halogen-free	3 x 1.00 mm ² 8 x 0.50 mm ²	Black	.457" (11.6 mm)
332	PUR, halogen-free	3 x 1.00 mm ² 12 x 0.50 mm ²	Black	.358" (9.1 mm)
242	PUR, halogen-free	3 x 1.00 mm ² 16 x 0.50 mm ²	Black	.453" (11.5 mm)

Part Number	Ports	Standard Cable Length	Characteristics
ASBV 4 5-256/...M	4	5M and 10M	
ASBV 6 5-332/...M	6	5M and 10M	
ASBV 8 5-242/...M	8	5M and 10M	

M12 Actuator/Sensor Distribution Boxes

ASBV.../LED



8-Ports (LED)

Actuator/sensor distribution box with LED operation and function indicators, top-entry, 4-, 6-, and 8-ports, M12 sockets, 5-poles, 2 signals per socket, with integrated control cable.

– control cable is suitable for c-track applications –

4-Ports

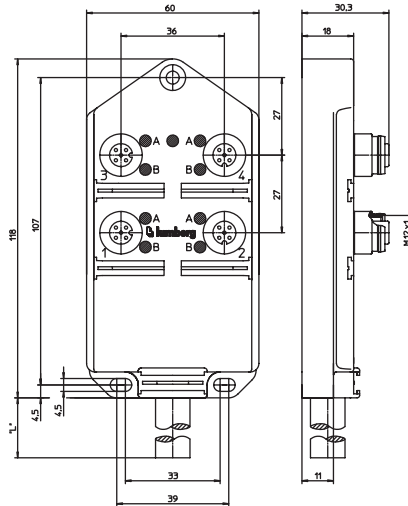

6-Ports

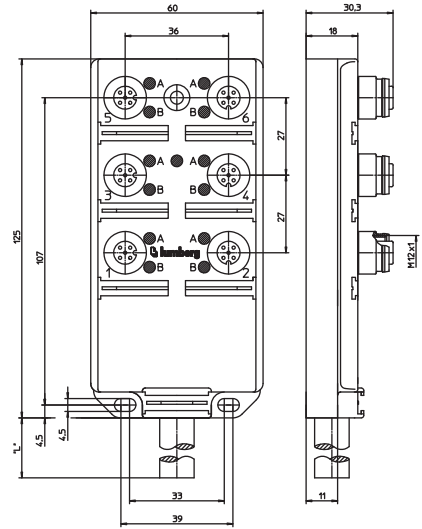

Pin Assignments

M12

Wiring Diagrams



4-Ports

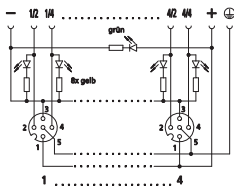

- | | | |
|-----|--------------|------|
| 1 = | brown | (C1) |
| 2 = | grey/pink | (1) |
| | red/blue | (2) |
| | white/green | (3) |
| | brown/green | (4) |
| | blue | (C3) |
| | white | (1) |
| | green | (2) |
| | yellow | (3) |
| | grey | (4) |
| 5 = | green/yellow | (PE) |

6-Ports

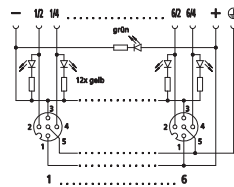

- | | | | | | |
|-----|--------------|------|-----|--------------|-----|
| 1 = | brown | (C1) | 4 = | white | (1) |
| 2 = | grey/pink | (1) | | green | (2) |
| | red/blue | (2) | | yellow | (3) |
| | white/green | (3) | | grey | (4) |
| | brown/green | (4) | | pink | (5) |
| | white/yellow | (5) | | red | (6) |
| | yellow/brown | (6) | 5 = | green/yellow | |
| 3 = | blue | (-) | | (PE) | |

8-Ports

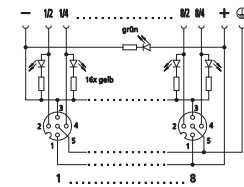

- | | | | | | |
|-----|--------------|------|-----|--------------|------|
| 1 = | brown | (C1) | 3 = | blue | (-) |
| 2 = | grey/pink | (1) | 4 = | white | (1) |
| | red/blue | (2) | | green | (2) |
| | white/green | (3) | | yellow | (3) |
| | brown/green | (4) | | grey | (4) |
| | white/yellow | (5) | | pink | (5) |
| | yellow/brown | (6) | | red | (6) |
| | white/yellow | (7) | | black | (7) |
| | grey/brown | (8) | | violet | (8) |
| | | | 5 = | green/yellow | (PE) |



Be Certain with Belden

M12 Actuator/Sensor Distribution Boxes

ASBV 4/LED 5-256 | ASBV 6/LED 5-332 | ASBV 8/LED 5-242

8-Ports

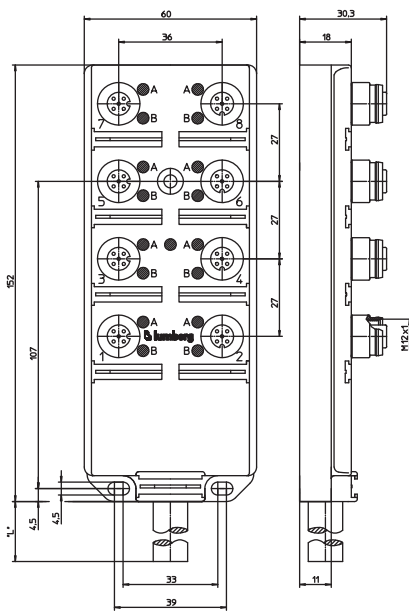

Technical Data

Environmental

Degree of protection IP 67 / NEMA 6P
 Operating temperature range -15°C (+5°F) / +80°C (+176°F)

Mechanical

Housing TPU, self-extinguishing
 Insert PA GF, self-extinguishing
 Contact CuZn, pre-nickel and 0.8 microns gold-plated
 Receptacle shell CuZn, nickel-plated
 O-ring FKM

Electrical

Contact resistance ≤5mΩ
 Voltage rating 10-30 V DC
 Current rating 4 A per port / 12 A max. total
 Insulation resistance > 10⁹ Ω

Accessories (included)

ZVK 2 dust covers for unused sockets
 ZBS 10 attachable labels

Cable Specifications

Cable No.	Outer Jacket	Conductor Size	Color	Outside Diameter
256	PUR, halogen-free	3 x 1.00 mm ² 8 x 0.50 mm ²	Black	.457" (11.6 mm)
332	PUR, halogen-free	3 x 1.00 mm ² 12x 0.50 mm ²	Black	.358" (9.1 mm)
242	PUR, halogen-free	3 x 1.00 mm ² 16 x 0.50 mm ²	Black	.453" (11.5 mm)

Part Number	Ports	Standard Cable Length	Characteristics
ASBV 4/LED 5-256/...M	4	5M, 10M, 15M	
ASBV 6/LED 5-332/...M	6	5M, 10M, 15M	
ASBV 8/LED 5-242/...M	8	5M, 10M, 15M	

M12 Actuator/Sensor Distribution Boxes

ASBV



4- and 8-Ports (Dual Solenoids)

Actuator distribution box with dual solenoids, 8-ports, top-entry, M12 sockets, 3-poles, 2 signals per socket, with Mini quick-disconnect control cable.

– control cable is suitable for c-track applications –

4-Ports

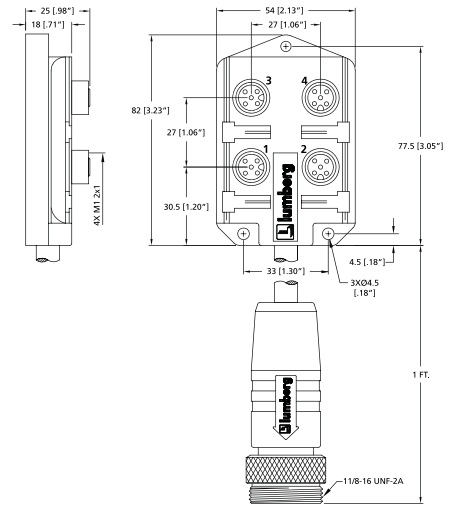

Pin Assignments

M12 / Mini 1 1/8"

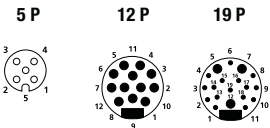

Wiring Diagrams

4-Ports

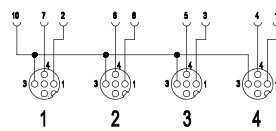

- 1 = brown/green
- 2 = grey/pink
- 3 = white/green
- 4 = grey
- 5 = yellow
- 6 = green
- 7 = white
- 8 = red/blue
- 9 = n.c.
- 10 = blue (-)
- 11 = n.c.
- 12 = n.c.

8-Ports

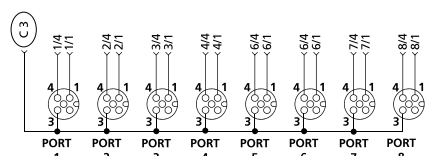

- | | | |
|-------------------|----------------|----------------|
| 1 = grey/pink (1) | 19 = white(1) | 15 = green (2) |
| red/blue (2) | 4 = green (2) | 6 = yellow (3) |
| white/green (3) | 8 = grey (4) | 16 = pink (5) |
| brown/green (4) | 14 = red (6) | 17 = black (7) |
| white/yellow (5) | 9 = violet (8) | 1 = violet (8) |
| yellow/brown (6) | 13 = n.c. | 7 = n.c. |
| white/grey (7) | 10 = n.c. | |
| grey/brown(8) | 18 = n.c. | |
| 3 = blue (C3) (-) | 5 = n.c. | |



Be Certain with Belden

M12 Actuator/Sensor Distribution Boxes

ASBV 4 4-3-138/RS120M | ASBV 8 4-3-139/RS190M

8-Ports

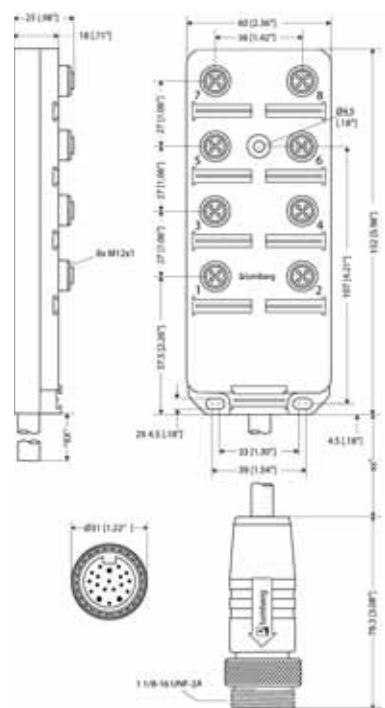

Technical Data

Environmental

Degree of protection IP 67 / NEMA 6P
 Operating temperature range -15°C (+5°F) / +90°C (+194°F)

Mechanical

Housing PUR, grey
 Insert Nylon
 Contact CuZn, gold plated
 Receptacle shell CuZn, nickel-plated
 O-ring FKM

Mini Quick Disconnect

Molded body PUR, yellow
 Insert PUR, yellow
 Contact CuZn, gold plated
 Coupling nut Aluminum, black anodized

Electrical

Contact resistance ≤5mΩ
 Voltage rating 250 V
 Current rating 4 A per port / 12 A max. total
 Insulation resistance > 10⁹ Ω

Accessories (included)

ZVK 2 dust covers for unused sockets
 ZBS 10 attachable labels

Cable Specifications

Cable No.	Outer Jacket	Conductor Size	Color	Outside Diameter
138	PUR/PVC	1 x 0.75 mm ² 8 x 0.34 mm ²	Black	.354" (9.0 mm)
139	PUR/PVC	1 x 1.00 mm ² 16 x 0.34 mm ²	Black	.425" (10.8 mm)

Part Number	Ports	Standard Cable Length	Characteristics
ASBV 4 4-3-138/RS120M	4	1F	
ASBV 8 4-3-139/RS190M	8	1F	

M12 Actuator/Sensor Distribution Boxes

ASBV...LED



4- and 8-Ports (LED)

Pluggable actuator/sensor distribution box with LED operation and function indicators, 4- and 8-ports, top-entry, M12 sockets, 5-poles, 2 signals per socket, with integrated Mini quick-disconnect control cable.

– control cable is suitable for c-track applications –

4-Ports

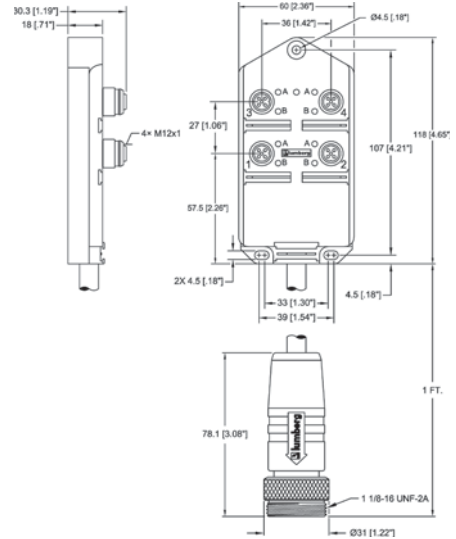

Pin Assignments

M12 / Mini 1 1/8"

Wiring Diagrams

5 P 12 P 19 P

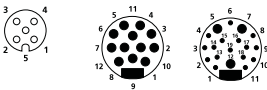

4-Ports

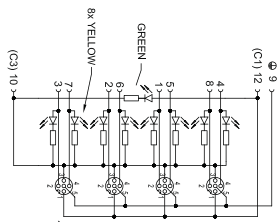

- | | | |
|------------------|-------|----|
| 1 = brown | (C1) | 12 |
| 2 = grey/pink | (1) | 3 |
| red/blue | (2) | 2 |
| white/green | (3) | 1 |
| brown/green | (4) | 8 |
| 3 = blue | (C3) | 10 |
| 4 = white | (1) | 7 |
| green | (2) | 6 |
| yellow | (3) | 5 |
| grey | (4) | 4 |
| 5 = yellow/green | (gnd) | 9 |

8-Ports

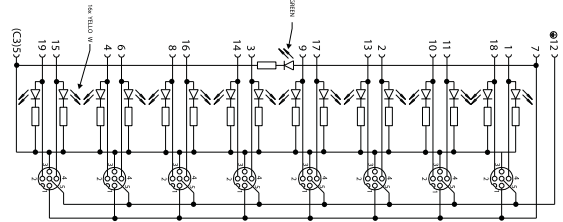

- | | | |
|------------------|-------|------|
| 1 = brown | (C1) | (7) |
| 2 = grey/pink | (1) | (19) |
| red/blue | (2) | (4) |
| white/green | (3) | (8) |
| brown/green | (4) | (14) |
| white/yellow | (5) | (9) |
| yellow/brown | (6) | (13) |
| white/grey | (8) | (18) |
| 3 = blue | (C3) | (5) |
| 4 = white | (1) | (15) |
| green | (2) | (6) |
| yellow | (3) | (16) |
| grey | (4) | (3) |
| pink | (5) | (17) |
| red | (6) | (2) |
| black | (7) | (11) |
| violet | (8) | (1) |
| 5 = yellow/green | (gnd) | (12) |



Be Certain with Belden

M12 Actuator/Sensor Distribution Boxes
 ASBV 4/LED 5-256/RS120M | ASBV 8/LED 5-242/RS190M

8-Ports

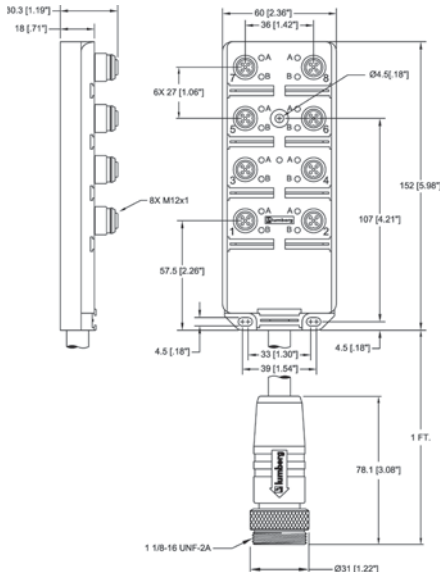

Technical Data

Environmental

Degree of protection IP 67 / NEMA 6P
 Operating temperature range -15°C (+5°F) / +90°C (+194°F)

Mechanical

Housing PUR, yellow
 Insert Nylon
 Contact CuZn, gold plated
 Receptacle shell CuZn, nickel-plated
 O-ring FKM

Mini Quick Disconnect

Molded body PUR, yellow
 Insert PUR, yellow
 Contact CuZn, gold plated
 Coupling nut Aluminum, black anodized

Electrical

Contact resistance $\leq 5m\Omega$
 Voltage rating 10-30 V DC
 Current rating 4 A per port / 12 A max. total
 Insulation resistance $> 10^9 \Omega$

Accessories (included)

ZVK 2 dust covers for unused sockets
 ZBS 10 attachable labels

Cable Specifications

Cable No.	Outer Jacket	Conductor Size	Color	Outside Diameter
256	PUR	3 x 1.75 mm ² 8 x 0.50 mm ²	Black	.366" (9.3 mm)
242	PUR	3 x 1.00 mm ² 16 x 0.50 mm ²	Black	.457" (11.6 mm)

Part Number	Ports	Standard Cable Length	Characteristics
ASBV 4/LED 5-256/RS120M	4	1F	
ASBV 8/LED 5-242/RS190M	8	1F	

M12 Actuator/Sensor Distribution Boxes

ASBS



6- and 8-Ports

Pluggable actuator/sensor distribution box, 6- and 8-ports, top-entry, M12 sockets, 4-poles, 1 signals per socket, with M23 quick-disconnect for the control cable.

– control cable type: 12P: RKU 12-256/...M or RKWU 12-256/...M –

6-Ports

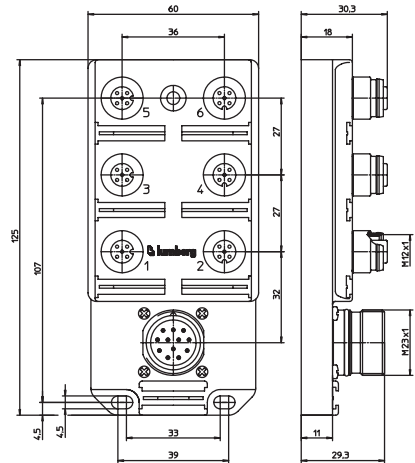

Pin Assignments

M12 / M23

Wiring Diagrams

5 P

12 P

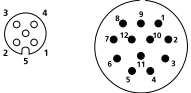

6-Ports

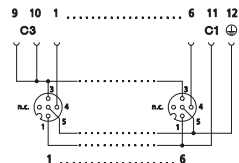

- | | | |
|-----|------|------|
| 1 = | 11 | (C1) |
| 2 = | n.c. | |
| 3 = | 9 | (C3) |
| 4 = | 1 | (1) |
| | 2 | (2) |
| | 3 | (3) |
| | 4 | (4) |
| | 5 | (5) |
| | 6 | (6) |
| 5 = | 12 | (PE) |

8-Ports

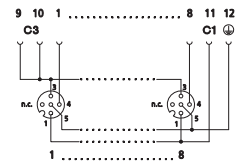

- | | | |
|-----|------|------|
| 1 = | 11 | (C1) |
| 2 = | n.c. | |
| 3 = | 9 | (C3) |
| 4 = | 1 | (1) |
| | 2 | (2) |
| | 3 | (3) |
| | 4 | (4) |
| | 5 | (5) |
| | 6 | (6) |
| | 7 | (7) |
| | 8 | (8) |
| 5 = | 12 | (PE) |



Be Certain with Belden

M12 Actuator/Sensor Distribution Boxes

ASBS 6 5-4 | ASBS 8 5-4

8-Ports

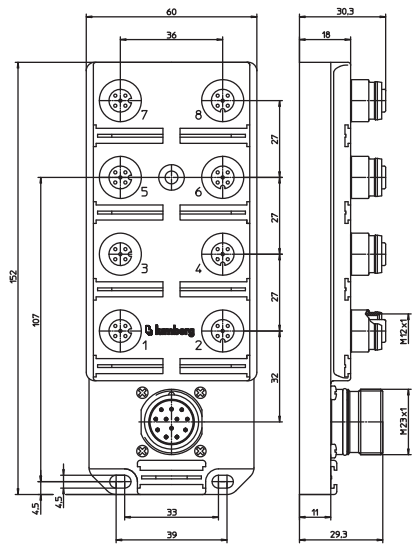

Technical Data

Environmental

Degree of protection IP 67 / NEMA 6P
 Operating temperature range -15°C (+5°F) / +80°C (+176°F)

Mechanical

Housing TPU, self-extinguishing
 Insert PA GF, self-extinguishing
 Contact CuZn, pre-nickel and 0.8 microns gold-plated
 Receptacle shell CuZn, nickel-plated
 O-ring FKM

Electrical

Contact resistance $\leq 5m\Omega$
 Voltage rating 250 V
 Current rating 4 A per port / 12 A max. total
 Insulation resistance $> 10^9 \Omega$

Accessories (included)

ZVK 2 dust covers for unused sockets
 ZBS 10 attachable labels

Part Number	Ports	Mating Control Cables	Characteristics
ASBS 6 5-4	6	RKU 12-256/...M or RKWU 12-256/...M	
ASBS 8 5-4	8	RKU 12-256/...M or RKWU 12-256/...M	

M12 Actuator/Sensor Distribution Boxes

ASBS.../LED



4-, 6- and 8-Ports (LED)

Pluggable actuator/sensor distribution box with LED operation and function indicators, 4-, 6-, and 8-ports, top-entry, M12 sockets, 4-poles, 1 signals per socket, with M23 quick-disconnect for the control cable.

– control cable type: 12P: RKU 12-256/...M or RKWU 12-256/...M –

4-Ports

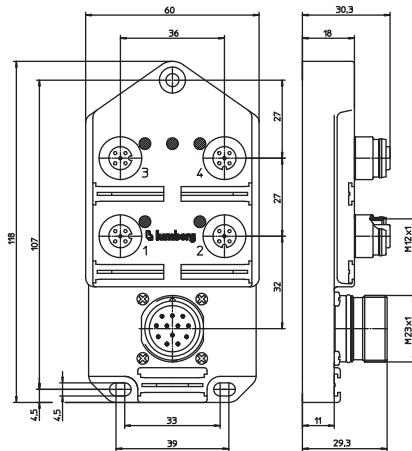

6-Ports

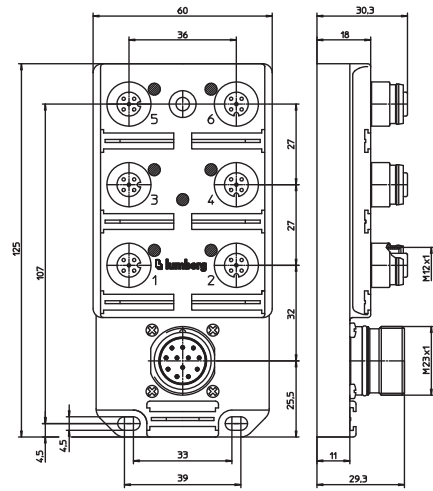

Pin Assignments

M12 / M23

Wiring Diagrams

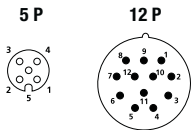

4-Ports

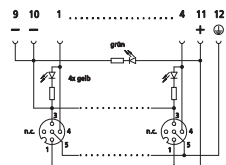

- 1 = 11 (+)
- 2 = n.c.
- 3 = 9 (-)
- 4 = 1 (1)
- 2 (2)
- 3 (3)
- 4 (4)
- 5 (5)
- 6 (6)
- 5 = 12 (PE)

6-Ports

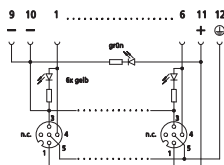

- 1 = 11 (+)
- 2 = n.c.
- 3 = 9 (-)
- 4 = 1 (1)
- 2 (2)
- 3 (3)
- 4 (4)
- 5 (5)
- 6 (6)
- 5 = 12 (PE)

8-Ports

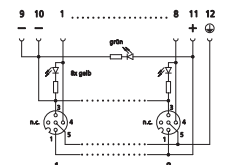

- 1 = 11 (+)
- 2 = n.c.
- 3 = 9 (-)
- 4 = 1 (1)
- 2 (2)
- 3 (3)
- 4 (4)
- 5 (5)
- 6 (6)
- 7 (7)
- 8 (8)
- 5 = 12 (PE)



Be Certain with Belden

Distribution Boxes

M12 Actuator/Sensor Distribution Boxes
 ASBS 4 5-4/LED | ASBS 6 5-4/LED | ASBS 8 5-4/LED

8-Ports

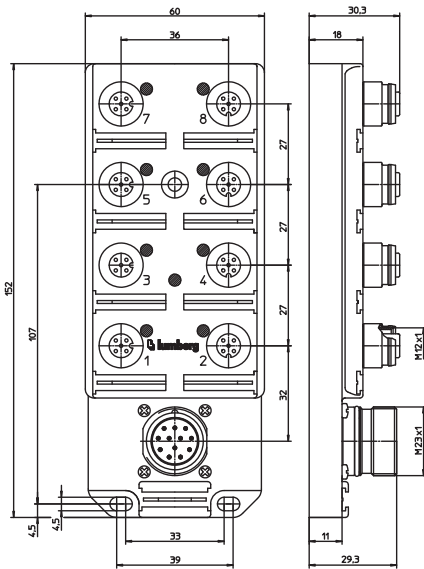

Technical Data

Environmental

Degree of protection IP 67 / NEMA 6P
 Operating temperature range -15°C (+5°F) / +80°C (+176°F)

Mechanical

Housing TPU, self-extinguishing
 Insert PA GF, self-extinguishing
 Contact CuZn, pre-nickel and 0.8 microns gold-plated
 Receptacle shell CuZn, nickel-plated
 O-ring FKM

Electrical

Contact resistance $\leq 5m\Omega$
 Voltage rating 10-30 V DC
 Current rating 4 A per port / 12 A max. total
 Insulation resistance $> 10^9 \Omega$

Accessories (included)

ZVK 2 dust covers for unused sockets
 ZBS 10 attachable labels

Part Number	Ports	Mating Control Cables	Characteristics
ASBS 4/LED 5-4	4	RKU 12-256/...M or RKWU 12-256/...M	
ASBS 6/LED 5-4	6	RKU 12-256/...M or RKWU 12-256/...M	
ASBS 8/LED 5-4	8	RKU 12-256/...M or RKWU 12-256/...M	

M12 Actuator/Sensor Distribution Boxes

ASBS 8/LED 5-4/4E4A



8-Ports (LED)

Pluggable actuator/sensor distribution box with LED operation and function indicators, to connect 4 standard sensors and actuators with separate power supply for inputs and outputs, 8-ports, top-entry, M12 sockets, 4-poles, 1 signals per socket, with M23 quick-disconnect for the control cable.

– field attachable type: 12P: RKC 120/13.5 or RKCW 13.5 –

8-Ports

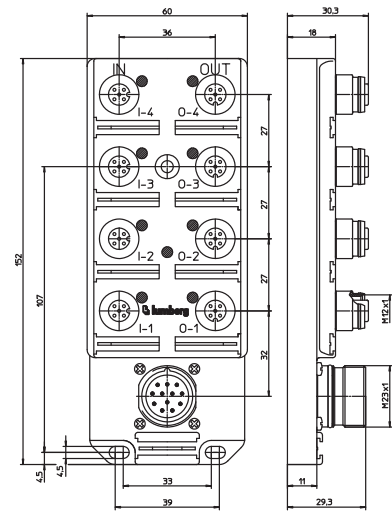

Pin Assignments

M12 / M23

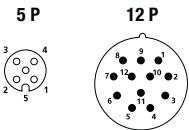

Wiring Diagrams

4-Ports

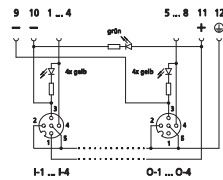

IN		OUT	
1 =	11 (+)	1 =	n.c.
2 =	12 (PE)	2 =	12 (PE)
3 =	10 (-)	3 =	9 (-)
4 =	1	4 =	5
	2		6
	3		7
	4		8
5 =	12 (PE)	5 =	12 (PE)



Be Certain with Belden

M12 Actuator/Sensor Distribution Boxes

ASBS 8/LED 5-4/4E4A

Technical Data

Environmental

Degree of protection IP 67 / NEMA 6P
 Operating temperature range -15°C (+5°F) / +80°C (+176°F)

Mechanical



Housing TPU, self-extinguishing
 Insert PA GF, self-extinguishing
 Contact CuZn, pre-nickelated and 0.8 microns gold-plated
 Receptacle shell CuZn, nickel-plated
 O-ring FKM

Electrical

Contact resistance $\leq 5m\Omega$
 Voltage rating 10-30 V DC
 Current rating 4 A per port / 12 A max. total
 Insulation resistance $> 10^9 \Omega$

Accessories (included)

ZVK 2 dust covers for unused sockets
 ZBS 10 attachable labels

Part Number	Ports	Mating Field Attachable for Control Connection	Characteristics
ASBS 8/LED 5-4/4E4A	8	RKC 120/13.5 or RKCW 120/13.5	  

M12 Actuator/Sensor Distribution Boxes

ASBSV



4-, 6-, and 8-Ports

Pluggable actuator/sensor distribution box, 4-, 6-, and 8-ports, top-entry, M12 sockets, 5-poles, 2 signals per socket, with M23 quick-disconnect for the control cable.

– control cable type: 19P: RKU 19-242/...M or RKWU 19-242/...M –

4-Ports

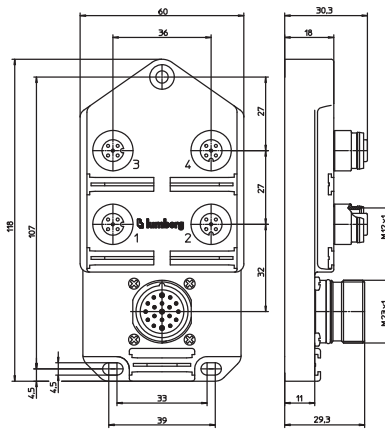

6-Ports

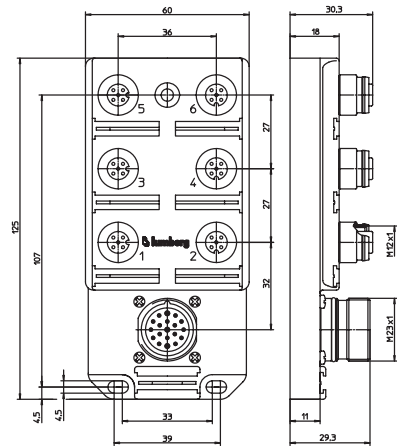

Pin Assignments

M12 / M23

Wiring Diagrams

5 P / 19 P

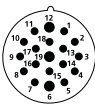

4-Ports

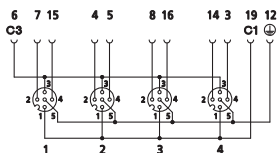

- 1 = 19 (C1)
- 2 = 1 (7)
- 2 = 2 (4)
- 3 = 3 (8)
- 4 = 4 (14)
- 3 = 6 (C3)
- 4 = 1 (15)
- 4 = 2 (5)
- 3 = 3 (16)
- 4 = 4 (3)
- 5 = 12 (PE)

6-Ports

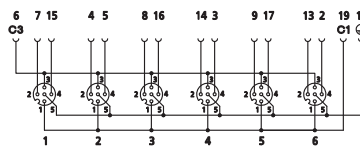

- 1 = 19 (C1)
- 2 = 1 (7)
- 2 = 2 (4)
- 3 = 3 (8)
- 4 = 4 (14)
- 5 = 5 (9)
- 6 = 6 (13)
- 3 = 6 (C3)
- 4 = 1 (15)
- 2 = 2 (5)
- 3 = 3 (16)
- 4 = 4 (3)
- 5 = 5 (17)
- 6 = 6 (2)
- 5 = 12 (PE)

8-Ports

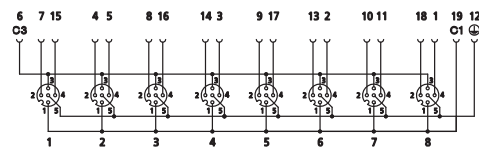

- 1 = 19 (C1)
- 2 = 1 (7)
- 2 = 2 (4)
- 3 = 3 (8)
- 4 = 4 (14)
- 5 = 5 (9)
- 6 = 6 (13)
- 7 = 7 (10)
- 8 = 8 (18)
- 3 = 6 (C3)
- 4 = 1 (15)
- 2 = 2 (5)
- 3 = 3 (16)
- 4 = 4 (3)
- 5 = 5 (17)
- 6 = 6 (2)
- 7 = 7 (11)
- 8 = 8 (1)
- 5 = 12 (PE)



Be Certain with Belden

M12 Actuator/Sensor Distribution Boxes

ASBSV 4 5-4 | ASBSV 6 5-4 | ASBSV 8 5-4

8-Ports

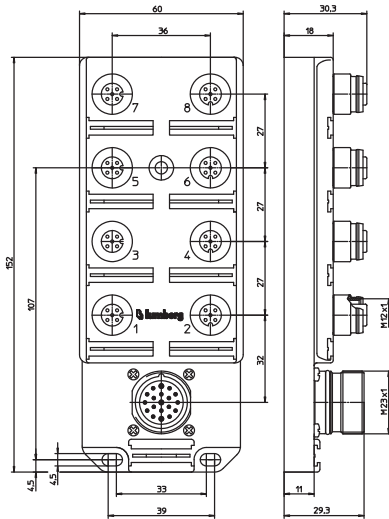

Technical Data

Environmental

Degree of protection IP 67 / NEMA 6P
 Operating temperature range -15°C (+5°F) / +80°C (+176°F)

Mechanical

Housing TPU, self-extinguishing
 Insert PA GF, self-extinguishing
 Contact CuZn, pre-nickel and 0.8 microns gold-plated
 Receptacle shell CuZn, nickel-plated
 O-ring FKM

Electrical

Contact resistance $\leq 5m\Omega$
 Voltage rating 250 V
 Current rating 4 A per port / 10 A max. total
 Insulation resistance $> 10^9 \Omega$

Accessories (included)

ZVK 2 dust covers for unused sockets
 ZBS 10 attachable labels

Part Number	Ports	Mating Control Cables	Characteristics
ASBSV 4 5-4	4	RKU 19-242/...M or RKWU 19-242/...M	
ASBSV 6 5-4	6	RKU 19-242/...M or RKWU 19-242/...M	
ASBSV 8 5-4	8	RKU 19-242/...M or RKWU 19-242/...M	

M12 Actuator/Sensor Distribution Boxes

ASBSV...LED



4-, 6-, and 8-Ports (LED)

Pluggable actuator/sensor distribution box with LED operation and function indicators, 4-, 6-, and 8-ports, top-entry, M12 sockets, 5-poles, 2 signals per socket, with M23 quick-disconnect for the control cable.

– control cable type: 19P: RKU 19-242/...M or RKWU 19-242/...M –

4-Ports

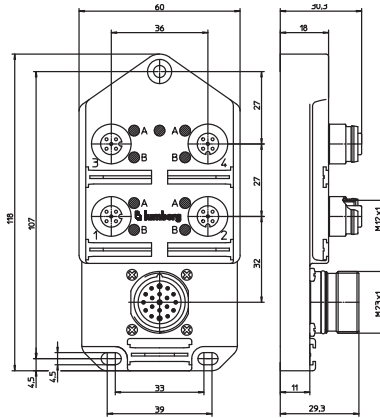

6-Ports

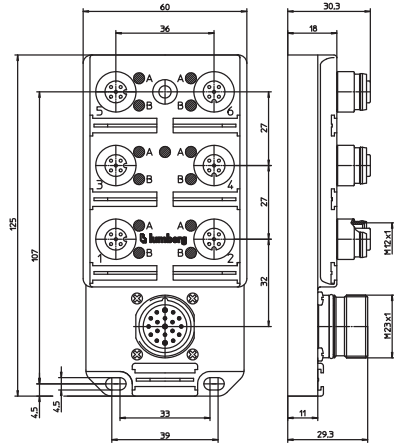

Pin Assignments

M12 / M23 Wiring Diagrams

5 P / 19 P

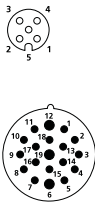

4-Ports

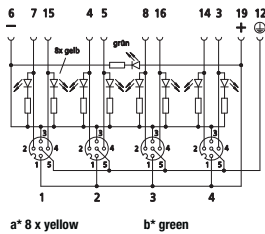

a* 8 x yellow b* green

- | | | |
|-----|----|------|
| 1 = | 19 | (C1) |
| 2 = | 1 | (7) |
| | 2 | (4) |
| | 3 | (8) |
| | 4 | (14) |
| 3 = | 6 | (C3) |
| 4 = | 1 | (15) |
| | 2 | (5) |
| | 3 | (16) |
| | 4 | (3) |
| 5 = | 12 | (PE) |

6-Ports

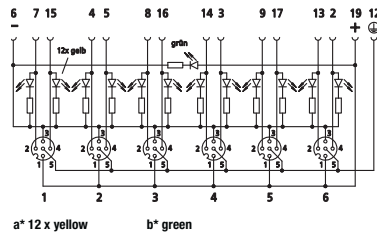

a* 12 x yellow b* green

- | | | |
|-----|----|------|
| 1 = | 19 | (C1) |
| 2 = | 1 | (7) |
| | 2 | (4) |
| | 3 | (8) |
| | 4 | (14) |
| | 5 | (9) |
| | 6 | (13) |
| 3 = | 6 | (C3) |
| 4 = | 1 | (15) |
| | 2 | (5) |
| | 3 | (16) |
| | 4 | (3) |
| | 5 | (17) |
| | 6 | (2) |
| 5 = | 12 | (PE) |

8-Ports

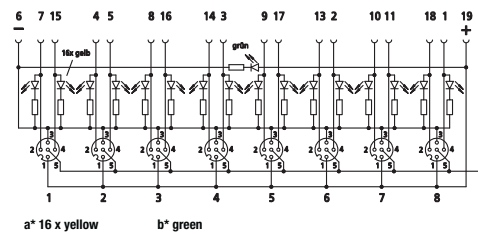

a* 16 x yellow b* green

- | | | |
|-----|----|------|
| 1 = | 19 | (C1) |
| 2 = | 1 | (7) |
| | 2 | (4) |
| | 3 | (8) |
| | 4 | (14) |
| | 5 | (9) |
| | 6 | (13) |
| | 7 | (10) |
| | 8 | (18) |
| 3 = | 6 | (C3) |
| 4 = | 1 | (15) |
| | 2 | (5) |
| | 3 | (16) |
| | 4 | (3) |
| | 5 | (17) |
| | 6 | (2) |
| | 7 | (11) |
| | 8 | (1) |
| 5 = | 12 | (PE) |



M12 Actuator/Sensor Distribution Boxes
 ASBSV 4/LED 5-4 | ASBSV 6/LED 5-4 | ASBSV 8/LED 5-4

8-Ports

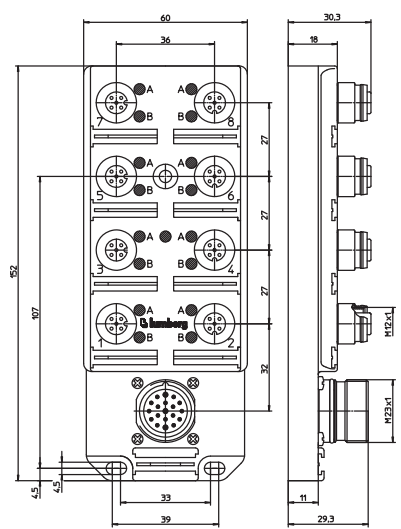

Technical Data

Environmental
 Degree of protection IP 67 / NEMA 6P
 Operating temperature range -15°C (+5°F) / +80°C (+176°F)

Mechanical
 Housing TPU, self-extinguishing
 Insert PA GF, self-extinguishing
 Contact CuZn, pre-nickel and 0.8 microns gold-plated
 Receptacle shell CuZn, nickel-plated
 O-ring FKM

Electrical
 Contact resistance $\leq 5m\Omega$
 Voltage rating 10-30 V DC
 Current rating 4 A per port / 10 A max. total
 Insulation resistance $> 10^9 \Omega$

Accessories (included)
 ZVK 2 dust covers for unused sockets
 ZBS 10 attachable labels

Part Number	Ports	Mating Control Cables	Characteristics
ASBSV 4/LED 5-4	4	RKU 19-242/...M or RKWU 19-242/...M	
ASBSV 6/LED 5-4	6	RKU 19-242/...M or RKWU 19-242/...M	
ASBSV 8/LED 5-4	8	RKU 19-242/...M or RKWU 19-242/...M	

M12 Actuator/Sensor Distribution Boxes

ASBSVD 8/LED W5



8-Ports (LED)

Pluggable actuator/sensor distribution box with LED operation and function indicators, 8-ports with integrated fuses and diagnostics display, top-entry, M12 sockets, 5-poles with M23 quick-disconnect for the control cable.

– control cable type: 19P: RKUF 19-242/...M or RKWUF 19-242/...M –

8-Ports

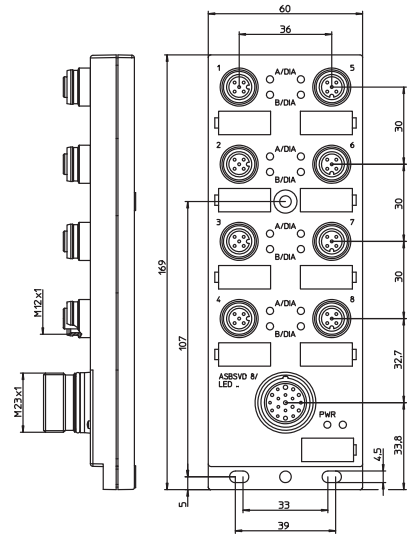

Pin Assignments

M12 / M23

5 P / 19 P

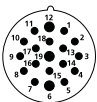

Wiring Diagrams

8-Ports

1 = +24 V (19)
 3 = -0 V (6)
 5 = 12 (PE)

Channel B		Channel A	
2 =	1 (7)	4 =	1 (15)
	2 (4)		2 (5)
	3 (8)		3 (16)
	4 (14)		4 (3)
	5 (9)		5 (17)
	6 (13)		6 (2)
	7 (10)		7 (11)
	DIA (18)		8 (1)

Diagnostic Indication

LED	Indication	Condition
1...8 A/B DIA	yellow/white	Function
1...8 A/B DIA	red	Periphery faults*
PWR	green	System power supply

* The peripheral error is sent as a collective message via the supply line to the control system. This message can be evaluated by the control system and issued as an error message. Therefore there is no channel B available for socket 8.



Be Certain with Belden

M12 Actuator/Sensor Distribution Boxes

ASBSVD 8/LED W5

Technical Data

Environmental

Degree of protection IP 67 / NEMA 6P
 Operating temperature range 0°C (+32°F) / +60°C (+140°F)

Mechanical

Housing PBT
 Insert M12 PA
 Contact M12 CuZn, pre-nickeled and 0.3 microns gold-plated
 O-ring M12 FKM
 Insert M23 PBT
 Contact M23 CuZn, pre-nickeled and 0.8 microns gold-plated
 O-ring M23 NBR
 Receptacle shell CuZn, nickel-plated

Electrical

Nominal current at 40°C 7.5 A max. total
 Nominal voltage 10-30 V DC
 Short circuit protection yes
 electronic fuses for all channels
 I max outputs 500 mA
 I max inputs 100 mA
 Operation indicator LED green
 Function indicator LED yellow/white
 Pollution degree 3

Accessories (included)

ZVK 2 dust covers for unused sockets
 ZBS 10 attachable labels

Part Number	Ports	Mating Control Cables	Characteristics
ASBSVD 8/LED W5	8	RKUF 19-242/...M or RKWUF 19-242/...M	 

Mini Actuator/Sensor Distribution Boxes

ZLU 4-30 | ZLU 4L 30 | ZLU 4-50



4-Ports

Distribution box, 4-ports with or without lamp indicators, side-entry, 7/8" sockets, 3- and 5-poles with integrated on-board quick-disconnect.

ZLU 4-30

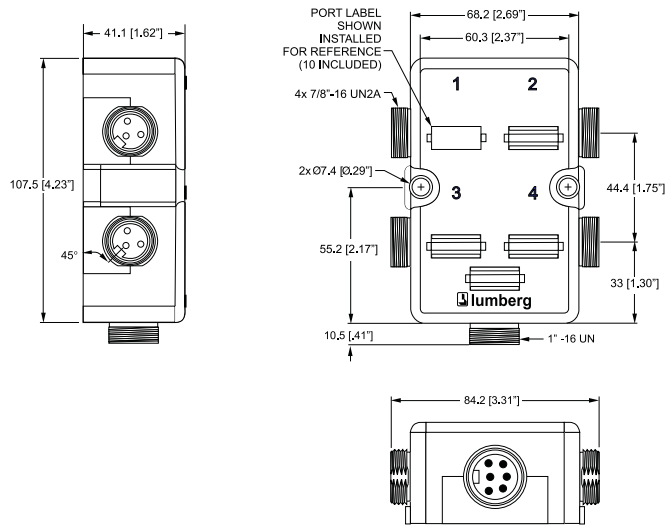

Wiring Diagrams

ZLU 4-30

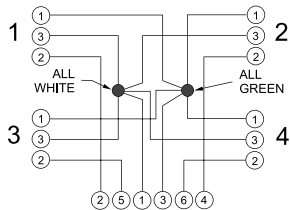

ZLU 4-50

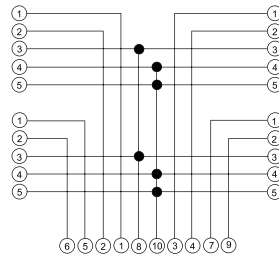

ZLU 4L-30

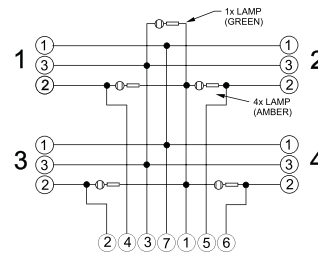

Pin Assignments

7/8" (

3 poles (ZLU 4-30)



- 1 = green
- 2 = black
- 3 = white

5 poles (ZLU 4-50)



- 1 = white
- 2 = red
- 3 = green
- 4 = orange
- 5 = black

7/8" (Control Connection)

6 poles (ZLU 4-30)



- 1 = white
- 2 = red
- 3 = green
- 4 = orange
- 5 = black
- 6 = blue

1" (Control Connection)

7 poles (ZLU 4L-30)



- 1 = white/black
- 2 = black
- 3 = white
- 4 = red
- 5 = orange
- 6 = green

1 1/8" (Control Connection)

10 poles (ZLU 4-50)



- 1 = orange
- 2 = blue
- 3 = white/black
- 4 = red/black
- 5 = green/black
- 6 = orange/black
- 7 = red
- 8 = green
- 9 = black
- 10 = white



Be Certain with Belden

Mini Actuator/Sensor Distribution Boxes

ZLU 4-30 | ZLU 4L 30 | ZLU 4-50

Technical Data

Environmental

Degree of protection

IP 67 / NEMA 6P

Operating temperature range

-25°C (-13°F) / +90°C (+194°F)

Mechanical

Housing

Polyester, glass filled, yellow TPE, black

I/O port shell

Zinc alloy, e-coated black

Control port shell

Aluminum, anodized black

Contacts

CuZn, gold plated

Insert

PUR, yellow

Electrical

Current rating

8 A per port

12 A max. per box

Voltage rating

600 V

Technical Data

ZLU 4L-30

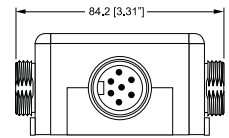
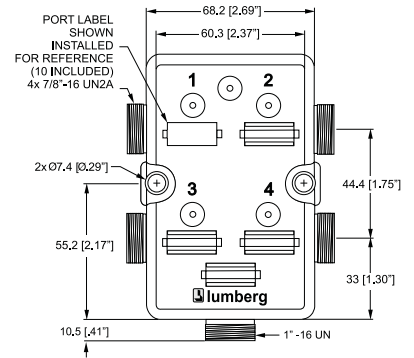
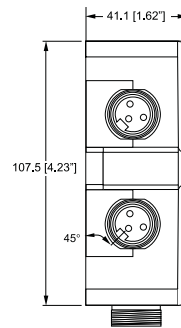

ZLU 4-50

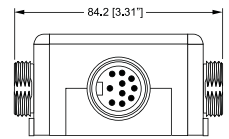
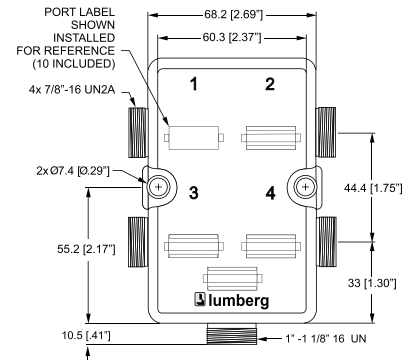
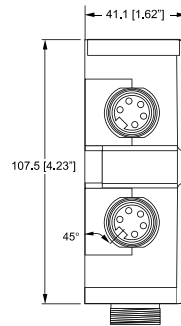

Part Number	Ports	Lamp Indicators	Mating Control Cables	Characteristics
ZLU 4-30	4		RSRK 601A-697/...F	
ZLU 4L-30	4	Lamps	RSRK 701M-622/...F	
ZLU 4-50	4		RSRK 1001M-699/...F	

M8 Actuator/Sensor Distribution Boxes

RSWU 12-SB 8/LED



8-Ports (LED)

Miniature sensor distribution box with LED operation and function indicators, 8-ports, top-entry, screw-lock M8 sockets, 3-poles, 1 signal per socket, earth connection, integrated control cable with M23 male right angle connector, 12-poles.

8-Ports

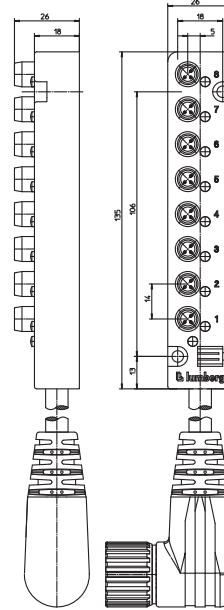

Pin Assignments

M8

M23

3 poles

12 poles

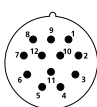



Be Certain with Belden

M8 Actuator/Sensor Distribution Boxes

RSWU 12-SB 8/LED

Technical Data

Environmental

Degree of protection IP 67 / NEMA 6P
 Operating temperature range -15°C (+5°F) / +90°C (+194°F)

Mechanical

Housing / Molded body TPU, self-extinguishing
 Insert RSWU: PBT
 SB: TPU, self-extinguishing
 Contact CuZn, pre-nickel and 0.8 microns gold-plated
 Receptacle shell CuZn, nickel-plated
 O-ring FKM

Electrical data

Contact resistance $\leq 5 \text{ m}\Omega$
 Nominal current at 40°C RSWU-SB: 2 A per outlet / 2 A max. total
 Nominal voltage 10–30 V DC
 Rated voltage 32 V
 Insulation resistance $> 109 \Omega$
 Pollution degree 3

Cable Specifications

Cable No.	Outer Jacket	Conductor Size	Jacket Color	OD
333	PUR, halogen-free	2 x 0.50 mm ² 8 x 0.34 mm ²	Black	.347" (8.8 mm)

Part Number	Ports	Mating Cordsets	Characteristics
RSWU 12-SB 8/LED 3-333/5 M	8	RSMV 3... or RSMWV 3...	

M12 Actuator/Sensor Distribution Boxes

RSWU 12-ASB 8/LED



8-Ports (LED)

Actuator/sensor distribution box with LED operation and function indicators, 8-ports, top-entry, M12 sockets, 4-poles, 1 signal per socket, earth connection, integrated control cable with M23 male right angle connector, 12-poles.

8-Ports

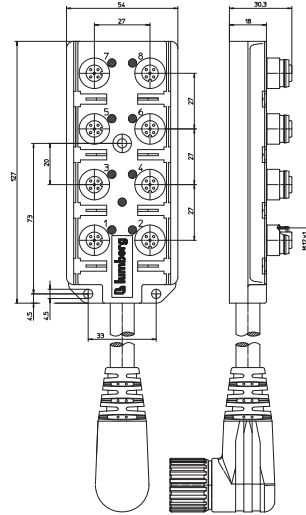

Pin Assignments

M12	M23
5-4 poles	12 poles



Be Certain with Belden

M12 Actuator/Sensor Distribution Boxes

RSWU 12-SB 8/LED

Technical Data

Environmental

Degree of protection IP 67 / NEMA 6P
 Operating temperature range -15°C (+5°F) / +90°C (+194°F)

Mechanical

Housing / Molded body TPU, self-extinguishing
 Insert RSWU: PBT
 ASB: PA, GF, self-extinguishing
 Contact CuZn, pre-nickel and 0.8 microns gold-plated
 Receptacle shell CuZn, nickel-plated
 O-ring FKM

Electrical data

Contact resistance ≤ 5 mΩ
 Nominal current at 40°C RSWU-ASB: 4 A per outlet /
 8 A max. total
 Nominal voltage 10–30 V DC
 Rated voltage 32 V
 Insulation resistance > 10⁹ Ω
 Pollution degree 3

Cable Specifications

Cable No.	Outer Jacket	Conductor Size	Jacket Color	OD
331	PUR, halogen-free	3 x 0.75 mm ² 8 x 0.34 mm ²	Black	.315" (8.0 mm)

Part Number	Ports	Mating Cordsets	Characteristics
RSWU 12-ASB 8/LED 5-4-331/5 M	8	RSMV 3... or RSMWV 3...	

M8-Round-Plug Connector, Single-Ended Cordsets, According to IEC 61976-2-104

RSMV | RSMWV



3- and 4-Poles

Actuator/sensor cordset, single-ended, M8, 3- and 4-poles male straight connector with self-locking threaded joint and molded cable.

RSMV

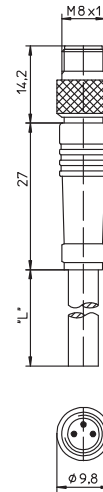

Actuator/sensor cordset, single-ended, M8, 3- and 4-poles male 90° connector with self-locking threaded joint and molded cable.

RSMWV

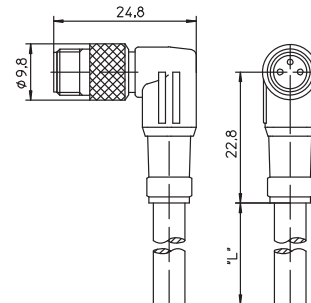

Pin Assignments

M8

3 poles

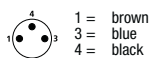

- 1 = brown
- 3 = blue
- 4 = black

4 poles



- 1 = brown
- 2 = white
- 3 = blue
- 4 = black

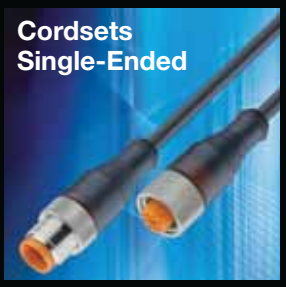

Be Certain with Belden

M8-Round-Plug Connector, Single-Ended Cordsets, According to IEC 61976-2-104

RSMV 3 | RSMV 4 | RSMWV 3 | RSMWV 4

Technical Data

Environmental

Degree of protection IP 67 / NEMA 6P
Operating temperature range -40°C (-40°F) / +90°C (+194°F)

Mechanical

Housing / Molded body TPU
Insert PA / TPU
Contact CuZn, pre-nickelated and 0.8 microns gold-plated
Coupling nut CuZn, nickel-plated

Electrical data

Contact resistance ≤ 5 mΩ
Nominal current at 40°C 4 A
Nominal voltage 3 poles 60 V
4 poles 30 V
Rated voltage 3 poles 63 V
4 poles 36 V
Test voltage 3 poles 1.5 kV eff. / 60 s
4 poles 0.8 kV eff. / 60 s
Insulation resistance > 10⁹ Ω
Pollution degree 3

Cable Specifications

Cable No.	Outer Jacket	Conductor Size	Jacket Color	OD
06	PVC	3 x 0.34 mm ²	Orange	.197" (5.0 mm)
07	PVC	4 x 0.75 mm ²	Orange	.197" (5.0 mm)
224	PUR, halogen-free	3 x 0.34 mm ²	Black	.169" (4.3 mm)
225	PUR, halogen-free	4 x 0.34 mm ²	Black	.185" (4.7 mm)

Part Number	Pins	Outer Jacket	Standard Cable Lengths	Characteristics
RSMV 3-06/...M	3	PVC	2 M / 5 M / 10 M	
RSMV 3-224/...M		PUR, halogen-free	2 M / 5 M / 10 M	
RSMV 4-07/...M	4	PVC	2 M / 5 M / 10 M	
RSMV 4-225/...M		PUR-halogen-free	2 M / 5 M / 10 M	

**M8-Round-Plug Connector, Single-Ended Cordsets,
According to IEC 61976-2-104**

RSM 8-354



8-Poles

Actuator/ sensor cord sets, single-ended, M8 male connector without snap-in joint and molded cable.

RSMV

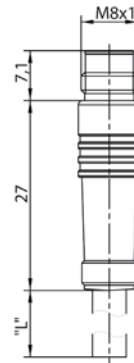

Pin Assignments

M8 8 Poles

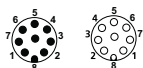

- | | |
|------------|----------|
| 1 = white | 5 = grey |
| 2 = brown | 6 = pink |
| 3 = green | 7 = blue |
| 4 = yellow | 8 = red |

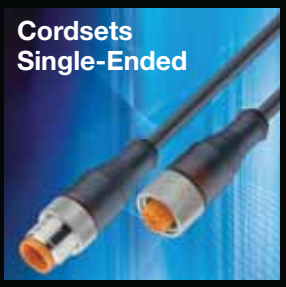

Be Certain with Belden

M8-Round-Plug Connector, Single-Ended Cordsets, According to IEC 61976-2-104
RSM 8-354

Technical Data

Environmental

Degree of protection IP x8 / NEMA 6P (15m/48h & 100m/2h)
Operating temperature range -25°C (-13°F) / +80°C (+176°F)

Mechanical

Housing / Molded body TPU
Insert TPU
Contact CuSn, & 0.8 microns gold-plated
Receptacle shell CuZn, nickel-plated
O-ring FKM

Electrical data

Contact resistance $\leq 5 \text{ m}\Omega$
Nominal current at 40°C 1 A
Nominal voltage 30 V
Rated voltage 36 V
Test voltage 0.8 kV eff. / 60 s
Insulation resistance $> 10^9 \Omega$
Pollution degree 3

Cable Specifications

Cable No.	Outer Jacket	Conductor Size	Jacket Color	OD
354	PUR, halogen-free	8 x 0.14 mm ²	Black	.197" (5.0 mm)

Part Number	Pins	Outer Jacket	Standard Cable Lengths	Characteristics
RSM 8-354/...M	8	PUR	2 M / 5 M / 10 M	   

M8-Round-Plug Connector, Single-Ended Cordsets, According to IEC 61976-2-104

RKMV | RKMVV



3-, 4-, and 8-Poles

Actuator/sensor cordset, single-ended, M8, 3-, 4-, and 8-poles, female straight connector with self-locking threaded joint and molded cable.

RKMV

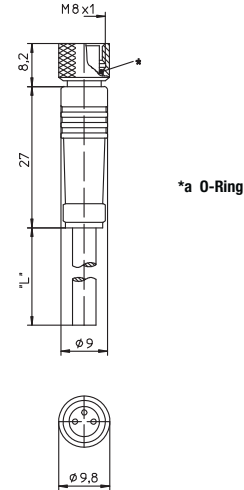

*a O-Ring



Actuator/sensor cordset, single-ended, M8, 3-, 4-, and 8-poles, female 90° connector with self-locking threaded joint and molded cable.

RKMVV

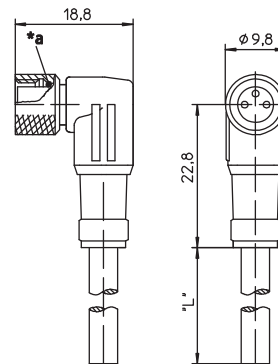

*a O-Ring

Pin Assignments

M8

3 poles

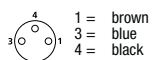

4 poles

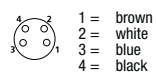

8 poles

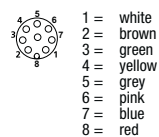

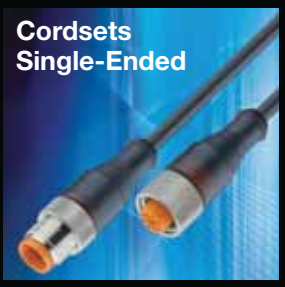

Be Certain with Belden

M8-Round-Plug Connector, Single-Ended Cordsets, According to IEC 61976-2-104

RKMV 3 | RKMV 4 | RKMV 8 | RKMWV 3 | RKMWV 4

Technical Data

Environmental

Degree of protection IP 67 / NEMA 6P
Operating temperature range -40°C (-40°F) / +90°C (+194°F)

Mechanical

Housing / Molded body TPU
Insert PA / TPU
Contact CuZn, pre-nickelated and 0.8 microns gold-plated
Coupling nut CuZn, nickel-plated

Electrical data

Contact resistance ≤ 5 mΩ
Nominal current at 40°C 4 A
Nominal voltage 3 poles 60 V
4 poles 30 V
Rated voltage 3 poles 63 V
4 poles 36 V
Test voltage 3 poles 1.5 kV eff. / 60 s
4 poles 0.8 kV eff. / 60 s
Insulation resistance > 10⁹ Ω
Pollution degree 3

Cable Specifications

Cable No.	Outer Jacket	Conductor Size	Jacket Color	OD
06	PVC	3 x 0.34 mm ²	Orange	.197" (5.0 mm)
07	PVC	4 x 0.75 mm ²	Orange	.197" (5.0 mm)
224	PUR, halogen-free	3 x 0.34 mm ²	Black	.169" (4.3 mm)
225	PUR, halogen-free	4 x 0.34 mm ²	Black	.185" (4.7 mm)
354	PUR, halogen-free	8 x 0.14 mm ²	Black	.197" (5.0 mm)

Part Number	Pins	Outer Jacket	Standard Cable Lengths	Characteristics
RKMV 3-06/...M	3	PVC	2 M / 5 M / 10 M	
RKMV 3-224/...M		PUR, halogen-free	2 M / 5 M / 10 M	
RKMV 4-07/...M	4	PVC	2 M / 5 M / 10 M	
RKMV 4-225/...M		PUR, halogen-free	2 M / 5 M / 10 M	
RKMV 8-354/...M	8	PUR, halogen-free	2 M / 5 M / 10 M	

**M8-Round-Plug Connector, Single-Ended Cordsets,
According to IEC 61976-2-104**

RKMWW/LED A 3



3-Poles (LED)

Actuator/sensor cordset, single-ended, M8
3-poles, female 90 connector with LED
operation and function indicator, self-locking
threaded joint and molded cable.

RKMWW/LED

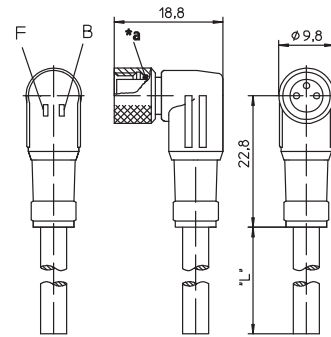

*a O-Ring

Pin Assignments

M8

Wiring Diagram

3 poles

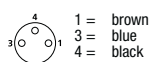

A pnp Normally open = yellow-green

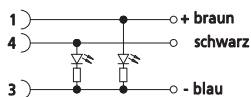

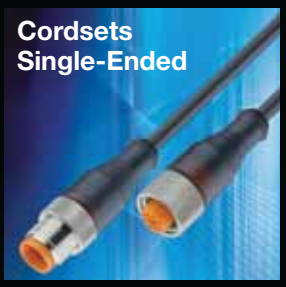

Be Certain with Belden

M8-Round-Plug Connector, Single-Ended Cordsets, According to IEC 61976-2-104
RKMWW/LED A 3

Technical Data

Environmental

Degree of protection IP 67/IP 69K / NEMA 6P
Operating temperature range -40°C (-40°F) / +90°C (+194°F)

Mechanical

Housing / Molded body TPU
Insert PA / TPU
Contact CuZn, pre-nickel and 0.8 microns gold-plated
Coupling nut CuZn, nickel-plated
O-Ring FKM

Electrical data

Contact resistance $\leq 5 \text{ m}\Omega$
Nominal current at 40°C 4 A
Nominal voltage 10-30 V DC
Insulation resistance $> 10^9 \Omega$
Pollution degree 3

Cable Specifications

Cable No.	Outer Jacket	Conductor Size	Jacket Color	OD
06	PVC	3 x 0.34 mm ²	Orange	.197" (5.0 mm)
224	PUR, halogen-free	3 x 0.34 mm ²	Black	.169" (4.3 mm)

Part Number	Pins	Outer Jacket	Standard Cable Lengths	Characteristics
RKMWW/LED A 3-06/...M	3	PVC	2 M / 5 M / 10 M	
RKMWW/LED A 3-224/...M		PUR, halogen-free	2 M / 5 M / 10 M	

**M8-Round-Plug Connector, Single-Ended Cordsets,
According to IEC 61976-2-104**

RKM | RKMW



3- and 4-Poles

Actuator/sensor cordset, single-ended, M8
3- and 4-poles, female straight connector with
snap-in joint and molded cable.

RKM

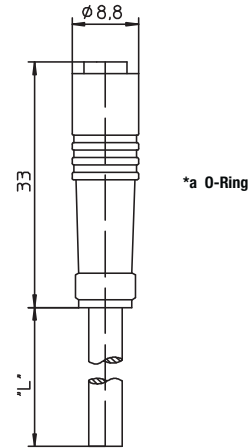

Actuator/sensor cordset, single-ended, M8 3-
and 4-poles, female 90° connector with snap-in
joint and molded cable.

RKMW

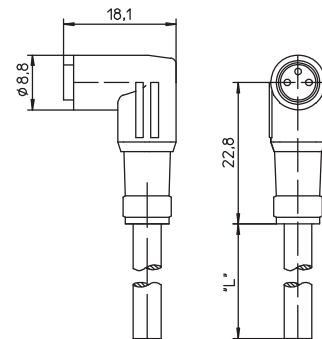

Pin Assignments

M8

3 poles

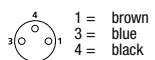

4 poles

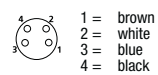

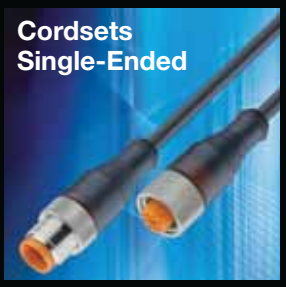

Be Certain with Belden

M8-Round-Plug Connector, Single-Ended Cordsets, According to IEC 61976-2-104

RKM 3 | RKM 4 | RKMW 3 | RKMW 4

Technical Data

Environmental

Degree of protection IP 65
Operating temperature range -40°C (-40°F) / +90°C (+194°F)

Mechanical









Housing / Molded body TPU
Insert PA / TPU
Contact CuZn, pre-nickelated and 0.8 microns gold-plated
Coupling nut CuZn, nickel-plated

Electrical data

Contact resistance ≤ 5 mΩ
Nominal current at 40°C 4 A
Nominal voltage 3 poles 60 V
4 poles 30 V
Rated voltage 3 poles 63 V
4 poles 36 V
Test voltage 3 poles 1.5 kV eff. / 60 s
4 poles 0.8 kV eff. / 60 s
Insulation resistance > 10⁹ Ω
Pollution degree 3

Cable Specifications

Cable No.	Outer Jacket	Conductor Size	Jacket Color	OD
06	PVC	3 x 0.34 mm ²	Orange	.197" (5.0 mm)
07	PVC	4 x 0.75 mm ²	Orange	.197" (5.0 mm)
224	PUR, halogen-free	3 x 0.34 mm ²	Black	.169" (4.3 mm)
225	PUR, halogen-free	4 x 0.34 mm ²	Black	.185" (4.7 mm)

Part Number	Pins	Outer Jacket	Standard Cable Lengths	Characteristics
RKM 3-06/...M	3	PVC	2 M / 5 M / 10 M	
RKM 3-224/...M		PUR, halogen-free	2 M / 5 M / 10 M	  
RKM 4-07/...M	4	PVC	2 M / 5 M / 10 M	
RKM 4-225/...M		PUR, halogen-free	2 M / 5 M / 10 M	  

**M8-Round-Plug Connector, Single-Ended Cordsets,
According to IEC 61976-2-104**

RKMW/LED



3-Poles (LED)

Actuator/sensor cordset, single-ended, M8, 3-poles, female 90° connector with LED operation and function indicator, with snap-in joint and molded cable.

RKMW/LED

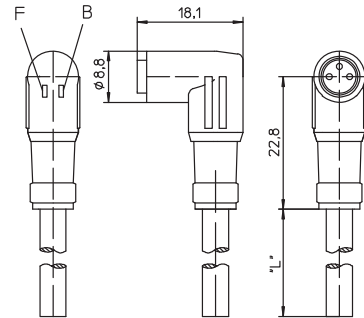

Pin Assignments

M8

3 poles

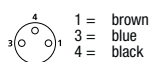

Wiring Diagram

A pnp Normally open = yellow-green

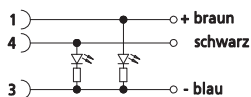

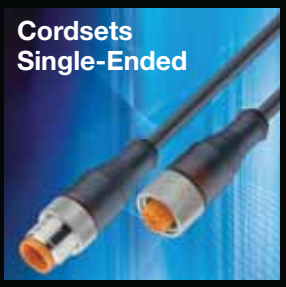

Be Certain with Belden

M8-Round-Plug Connector, Single-Ended Cordsets, According to IEC 61976-2-104
RKMW/LED 3

Technical Data

Environmental

Degree of protection IP 65
Operating temperature range -40°C (-40°F) / +90°C (+194°F)

Mechanical

Housing / Molded body TPU
Insert PA / TPU
Contact CuZn, pre-nickel and 0.8 microns gold-plated
Coupling nut CuZn, nickel-plated

Electrical data

Contact resistance ≤ 5 mΩ
Nominal current at 40°C 4 A
Nominal voltage 10-30 V DC
Insulation resistance > 10⁹ Ω
Pollution degree 3

Cable Specifications

Cable No.	Outer Jacket	Conductor Size	Jacket Color	OD
06	PVC	3 x 0.34 mm ²	Orange	.197" (5.0 mm)
224	PUR, halogen-free	3 x 0.34 mm ²	Black	.169" (4.3 mm)

Part Number	Pins	Outer Jacket	Standard Cable Lengths	Characteristics
RKMW/LED A 3-06/...M	3		2 M / 5 M / 10 M	
RKMW/LED A 3-224/...M			2 M / 5 M / 10 M	

**M8-Round-Plug Connector, Single-Ended Cordsets,
According to IEC 61976-2-104**

RKMVS | RKMVVS



3- and 4-Poles

Actuator/sensor cordset, single-ended, M8, 3- and 4-poles, female straight connector with self-locking threaded joint and molded cable, shielding connected to knurled nut.

RKMVS

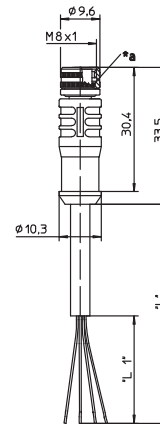

*a O-Ring
L 1 Stripping 30 mm



Actuator/sensor cordset, single-ended, M8, 3- and 4-poles, female 90° connector with self-locking threaded joint and molded cable, shielding connected to knurled nut.

RKMVVS

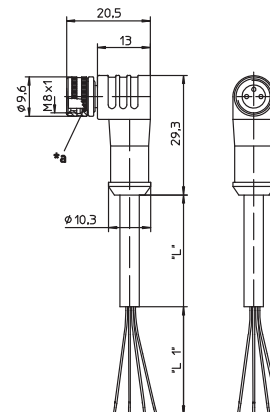

*a O-Ring
L 1 Stripping 30 mm

Pin Assignments

M8

3 poles

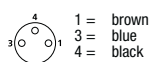

4 poles

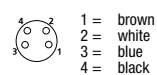



Be Certain with Belden

M8-Round-Plug Connector, Single-Ended Cordsets, According to IEC 61976-2-104

RKMVS | RKMWVS

Technical Data

Environmental

Degree of protection IP 67 / NEMA 6P
 Operating temperature range -30°C (-22°F) / +90°C (+194°F)

Mechanical

Housing / Molded body TPU
 Insert TPU, fibre-glass reinforced
 Contact CuZn, gold-plated
 Coupling nut CuZn, nickel-plated
 O-ring FKM

Electrical data

Contact resistance ≤ 5 mΩ
 Nominal current at 40°C 4 A
 Nominal voltage 3 poles 60 V
 4 poles 30 V
 Rated voltage 3 poles 63 V
 4 poles 36 V
 Test voltage 500 V eff. / 60 s
 Insulation resistance > 10⁹ Ω
 Pollution degree 3/2

Cable Specifications

Cable No.	Outer Jacket	Conductor Size	Jacket Color	OD
357	PUR, halogen-free	3 x 0.25 mm ²	Grey	.181" (4.6 mm)
358	PUR, halogen-free	4 x 0.25 mm ²	Grey	.205" (5.2 mm)

Part Number	Pins	Outer Jacket	Standard Cable Lengths	Characteristics
RKMVS 3-357/...M	3	PUR, halogen-free	5 M	
RKMVS 4-358/...M	4	PUR, halogen-free	5 M	

M12-Round-Plug Connector, Single-Ended Cordsets, According to IEC 61076-2-101

RST



3-, 4-, 5-, and 8-Poles

Actuator/sensor cordset, single-ended, M12,
3-, 4-, 5-, and 8-poles, male straight connector
with self-locking thread and molded cable.

RST

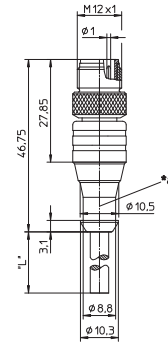

*a hose mounting



Pin Assignments

M12 - Male

3 poles

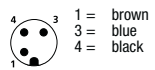

4 poles

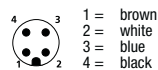

5 poles

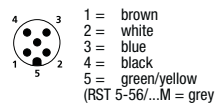

8 poles

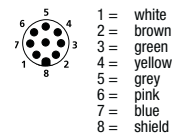



Be Certain with Belden

M12-Round-Plug Connector, Single-Ended Cordsets, According to IEC 61076-2-101 RST

Technical Data

Environmental

Degree of protection IP 67 / NEMA 6P
Operating temperature range -25°C (-13°F) / +80°C (+176°F)

Mechanical

Housing / Molded body TPU
Insert TPU
Contact CuSn, pre-nickel and 0.3 microns gold-plated
Coupling nut CuZn, nickel-plated

Electrical

Contact resistance ≤ 5 mΩ
Nominal current at 40°C 3-5 poles 4 A
8 poles 2 A
Nominal voltage 3-4 poles 240 V
5 poles 60 V
8 poles 30 V
Rated voltage 3-4 poles 250 V
5 poles 63 V
8 poles 36 V
Test voltage 3-4 poles 2.0 kV eff. / 60 s
5-8 poles 1.5 kV eff. / 60 s
Insulation resistance > 10⁹ Ω
Pollution degree 3

Cable Specifications

Cable No.	Outer Jacket	Conductor Size	Jacket Color	OD
06	PVC	3 x 0.34 mm ²	Orange	.197" (5.0 mm)
07	PVC	4 x 0.75 mm ²	Orange	.197" (5.0 mm)
56	PVC	5 x 0.34 mm ²	Orange	.224" (5.7 mm)
224	PUR, halogen-free	3 x 0.34 mm ²	Black	.169" (4.3 mm)
225	PUR, halogen-free	4 x 0.34 mm ²	Black	.185" (4.7 mm)
228	PUR, halogen-free	5 x 0.50 mm ²	Black	.213" (5.4 mm)
251	PUR, halogen-free welding spark proof	4 x 0.34 mm ²	Orange	.185" (4.7 mm)
259	PUR, halogen-free welding spark proof	5 x 0.50 mm ²	Orange	.217" (5.5 mm)
260	PUR, halogen-free welding spark proof	3 x 0.34 mm ²	Orange	.177" (4.5 mm)
282	PUR, halogen-free	7 x 0.25 mm ²	Black	.236" (6.0 mm)

Cordsets
Single-Ended

Part Number	Pins	Outer Jacket	Standard Cable Lengths	Characteristics
RST 3-06/...M	3	PVC	2 M / 5 M / 10 M	
RST 3-224/...M		PUR, halogen-free	2 M / 5 M / 10 M	
RST 3-260/...M		PUR, halogen-free / welding spark proof	2 M / 5 M / 10 M	
RST 4-07/...M	4	PVC	2 M / 5 M / 10 M	
RST 4-225/...M		PUR, halogen-free	2 M / 5 M / 10 M	
RST 4-251/...M		PUR, halogen-free / welding spark proof	2 M / 5 M / 10 M	
RST 5-56/...M	5	PVC	2 M / 5 M / 10 M	
RST 5-228/...M		PUR, halogen-free	2 M / 5 M / 10 M	
RST 5-259/...M		PUR, halogen-free / welding spark proof	2 M / 5 M / 10 M	
RST 8-282/...M	8	PUR, halogen-free	2 M / 5 M / 10 M	

**M12-Round-Plug Connector, Single-Ended Cordsets,
According to IEC 61076-2-101**

RST



RST 8-627

3-, 4-, 5-, and 8-Poles

Actuator/sensor cordset, single-ended, M12,
3-, 4-, 5-, and 8-poles, male straight connector
with self-locking thread and molded cable.

RST

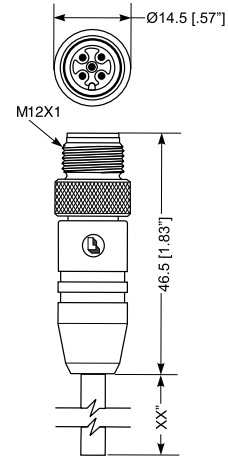

Pin Assignments

M12 - Male

3 poles

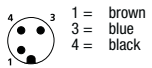

4 poles

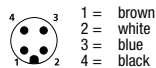

5 poles

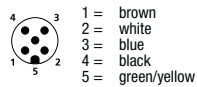

8 poles

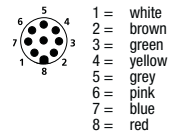



Be Certain with Belden

M12-Round-Plug Connector, Single-Ended Cordsets, According to IEC 61076-2-101 RST

Technical Data

Environmental

Degree of protection IP 67 / NEMA 6P
 Operating temperature range PUR: -40°C (-40°F) / +80°C (176°F)
 PVC: -40°C (-40°F) / +90°C (194°F)
 TPE: -40°C (-40°F) / +90°C (194°F)

Mechanical

Housing / Molded body PUR, yellow
 RST 8-627: PUR, black
 Insert PUR, Yellow
 RST 8-627: PUR, orange
 Contact CuSn, gold over nickel-plated
 Coupling nut CuZn, nickel-plated
 O-ring FKM

Electrical

Current rating 4 A
 Voltage rating 250 V
 RST 8-627: 60 V AC / 75 V DC

Cable Specifications

Cable No.	Outer Jacket	Gauge	Jacket Color	OD
602	PUR	18AWG	Yellow	.230" (5.9 mm)
610	PUR	22AWG	Yellow	.190" (4.8 mm)
612	PVC	22AWG	Yellow	.210" (5.3 mm)
627	PVC	24AWG	Black	.232" (5.9 mm)
632	PVC	22AWG	Yellow	.190" (4.8 mm)
633	PVC	22AWG	Yellow	.190" (4.8 mm)
637	TPE	18AWG	Yellow	.280" (7.1 mm)
643	TPE	22AWG	Yellow	.246" (6.2 mm)
644	PUR	22AWG	Yellow	.210" (5.3 mm)
645	PUR	18AWG	Yellow	.220" (5.6 mm)
679	PUR	22AWG	Yellow	.190" (4.8 mm)
731	TPE	18AWG	Yellow	.284" (7.2 mm)

Cordsets
Single-Ended

Part Number	Pins	Outer Jacket	Standard Cable Lengths	Characteristics
RST 3-731/...M	3	TPE	2 M / 5 M / 10 M	
RST 3-632/...M		PVC		
RST 3-645/...M		PUR		
RST 3-610/...M		PUR		
RST 4-637/...M	4	TPE	2 M / 5 M / 10 M	
RST 4-633/...M		PVC		
RST 4-643/...M		TPE		
RST 4-602/...M		PUR		
RST 4-679/...M		PUR		
RST 5-612/...M		5		PVC
RST 5-644/...M	PUR			
RST 8-627/...M	8		PVC	2 M / 5 M / 10 M

**M12-Round-Plug Connector, Single-Ended Cordsets,
According to IEC 61076-2-101**

RKT | RKWT



3-, 4-, 5-, 8-, and 12-Poles

Actuator/sensor cordset, single-ended, M12, 3-, 4-, 5-, 8-, and 12-poles, female straight connector with self-locking thread and molded cable.

RKT

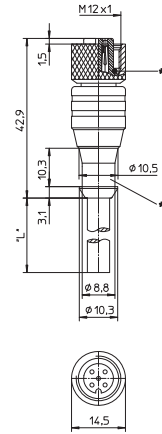

*a O-ring
* b Hose mounting



Actuator/sensor cordset, single-ended, M12, 3-, 4-, 5-, 8-, and 12-poles, female 90° connector with self-locking thread and molded cable.

RKT

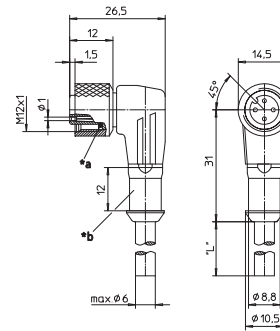

*a O-ring
* b Hose mounting

Pin Assignments

M12 - Male

3 poles

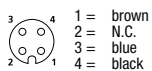

4 poles

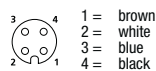

5 poles

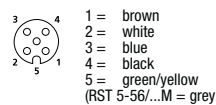

6 poles

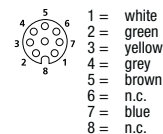

8 poles

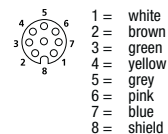

12 poles

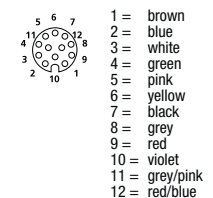



Be Certain with Belden

M12-Round-Plug Connector, Single-Ended Cordsets, According to IEC 61076-2-101 RKT | RKWT

Technical Data

Environmental

Degree of protection IP 67 / NEMA 6P
Operating temperature range -25°C (-13°F) / +80°C (+176°F)

Mechanical

Housing / Molded body TPU
Insert TPU
Contact CuSn (12 poles: CuZn), pre-nickeled and 0.3 microns gold-plated
Coupling nut CuZn, nickel-plated
O-ring FKM

Electrical

Contact resistance ≤ 5 mΩ
Nominal current at 40°C 3–5 poles 4 A, 6–12 poles 2 A
Rated voltage 3–4 poles 250 V
5 poles 63 V, 6–12 poles 36 V

Cable Specifications

Cable No.	Outer Jacket	Conductor Size	Jacket Color	OD
06	PVC	3 x 0.34 mm ²	Orange	.197" (5.0 mm)
07	PVC	4 x 0.25 mm ²	Orange	.197" (5.0 mm)

Cable No.	Outer Jacket	Conductor Size	Jacket Color	OD
56	PVC	5 x 0.34 mm ²	Orange	.224" (5.7 mm)
224	PUR, halogen-free	3 x 0.34 mm ²	Black	.169" (4.3 mm)
225	PUR, halogen-free	4 x 0.34 mm ²	Black	.185" (4.7 mm)
228	PUR, halogen-free	5 x 0.50 mm ²	Black	.213" (5.4 mm)
251	PUR, halogen-free welding spark proof	4 x 0.34 mm ²	Orange	.185" (4.7 mm)
259	PUR, halogen-free welding spark proof	5 x 0.50 mm ²	Orange	.217" (5.5 mm)
260	PUR, halogen-free welding spark proof	3 x 0.34 mm ²	Orange	.177" (4.5 mm)
268	PUR, halogen-free welding spark proof	6 x 0.34 mm ²	Orange	.236" (6.0 mm)
282	PUR, halogen-free	7 x 0.25 mm ²	Black	.236" (6.0 mm)
337	PUR, halogen-free	6 x 0.34 mm ²	Black	.236" (6.0 mm)
348	PUR, halogen-free	2 x 0.25 mm ² 10 x 0.14 mm ²	Black	.236" (6.0 mm)

Part Number		Pins	Outer Jacket	Standard Cable Lengths	Characteristics
RKT 4-3-06/...M	RKWT 4-3-06/...M	3	PVC	2 M / 5 M / 10 M	
RKT 4-3-224/...M	RKWT 4-3-224/...M		PUR, halogen-free	2 M / 5 M / 10 M	
RKT 4-3-260/...M	RKWT 4-3-260/...M		PUR, halogen-free / welding spark proof	2 M / 5 M / 10 M	
RKT 4-07/...M	RKWT 4-07/...M	4	PVC	2 M / 5 M / 10 M	
RKT 4-225/...M	RKWT 4-225/...M		PUR, halogen-free	2 M / 5 M / 10 M	
RKT 4-251/...M	RKWT 4-251/...M		PUR, halogen-free / welding spark proof	2 M / 5 M / 10 M	
RKT 5-56/...M	RKWT 5-56/...M	5	PVC	2 M / 5 M / 10 M	
RKT 5-228/...M	RKWT 5-228/...M		PUR, halogen-free	2 M / 5 M / 10 M	
RKT 5-259/...M	RKWT 5-259/...M		PUR, halogen-free / welding spark proof	2 M / 5 M / 10 M	
RKT 8-6-268/...M	RKWT 8-6-268/...M	6	PUR, halogen-free / welding spark proof	2 M / 5 M / 10 M	
RKT 8-6-337/...M	RKWT 8-6-337/...M		PUR, halogen-free / welding spark proof	2 M / 5 M / 10 M	
RKT 8-282/...M	RKWT 8-282/...M	8	PUR, halogen-free	2 M / 5 M / 10 M	
RKT 12-348/...M	RKWT 12-348/...M	12	PUR, halogen-free	2 M / 5 M / 10 M	

**M12-Round-Plug Connector, Single-Ended Cordsets,
According to IEC 61076-2-101**

RKT | RKWT



3-, 4-, 5-, and 8-Poles

Actuator/sensor cordset, single-ended, M12, 3-, 4-, 5-, and 8-poles, female straight connector with self-locking thread and molded cable.

RKT

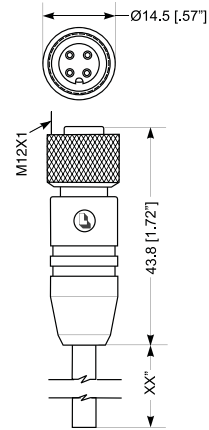

Actuator/sensor cordset, single-ended, M12, 3-, 4-, 5-, and 8-poles, female 90° connector with self-locking thread and molded cable.

– RKWT 8-627 has black cable and overmolde –

RKWT

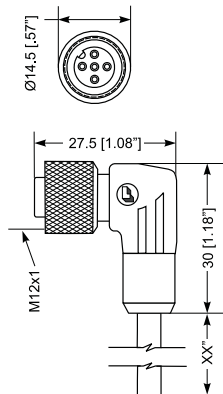

Pin Assignments

M12 - Male

3 poles



4 poles

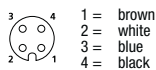

5 poles

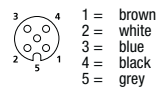

8 poles

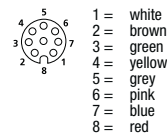



Be Certain with Belden

M12-Round-Plug Connector, Single-Ended Cordsets, According to IEC 61076-2-101

RKT | RKWT

Technical Data

Environmental

Degree of protection	IP 67 / NEMA 6P
Operating temperature range	PUR: -40°C (-40°F) / +80°C (176°F) PVC: -40°C (-40°F) / +90°C (194°F) TPE: -40°C (-40°F) / +90°C (194°F)

Mechanical

Housing / Molded body	TPU, yellow RST 8-627: PUR, black
Insert	TPU, Yellow RST 8-627: PUR, orange
Contact	CuSn, gold over nickel-plated
Coupling nut	CuZn, nickel-plated
O-ring	FKM

Electrical

Current rating	4 A
Voltage rating	250 V RST 8-627: 60 V AC / 75 V DC

Cable Specifications

Cable No.	Outer Jacket	Gauge	Jacket Color	OD
602	PUR	18AWG	Yellow	.230" (5.8 mm)
610	PUR	22AWG	Yellow	.190" (4.8 mm)
612	PVC	22AWG	Yellow	.210" (5.3 mm)
627	PVC	24AWG	Black	.232" (5.9 mm)
632	PVC	22AWG	Yellow	.190" (4.8 mm)
633	PVC	22AWG	Yellow	.190" (4.8 mm)
637	TPE	18AWG	Yellow	.280" (7.1 mm)
643	TPE	22AWG	Yellow	.246" (6.2 mm)
644	PUR	22AWG	Yellow	.210" (5.3 mm)
645	PUR	18AWG	Yellow	.220" (5.6 mm)
679	PUR	22AWG	Yellow	.190" (4.8 mm)
731	TPE	18AWG	Yellow	.261" (6.6 mm)

Cordsets
Single-Ended

Part Number	Pins	Outer Jacket	Standard Cable Lengths	Characteristics
RKT 4-3-731/...M RKWT 4-3-731/...M	3	TPE	2 M / 5 M / 10 M	
RKT 4-3-632/...M RKWT 4-3-632/...M		PVC	2 M / 5 M / 10 M	
RKT 4-3-645/...M RKWT 4-3-645/...M		PUR	2 M / 5 M / 10 M	
RKT 4-3-610/...M RKWT 4-3-610/...M		PUR	2 M / 5 M / 10 M	
RKT 4-637/...M RKWT 4-637/...M	4	TPE	2 M / 5 M / 10 M	
RKT 4-633/...M RKWT 4-633/...M		PVC	2 M / 5 M / 10 M	
RKT 4-643/...M RKWT 4-643/...M		TPE	2 M / 5 M / 10 M	
RKT 4-602/...M RKWT 4-602/...M		PUR	2 M / 5 M / 10 M	
RKT 4-679/...M RKWT 4-679/...M		PUR	2 M / 5 M / 10 M	
RKT 5-612/...M RKWT 5-612/...M	5	PVC	2 M / 5 M / 10 M	
RKT 5-644/...M RKWT 5-644/...M		PUR	2 M / 5 M / 10 M	
RKT 8-627/...M RKWT 8-627/...M	8	PVC	2 M / 5 M / 10 M	

**M12-Round-Plug Connector, Single-Ended Cordsets,
According to IEC 61076-2-101**

RKT/LED | RKWT/LED



3- and 4-Poles (LED)

Actuator/sensor cordset, single-ended, M12, 3-, 4-, 5-, 8-, and 12-poles, female straight connector with LED operation and function indicator with self-locking thread and molded cable.

RKT/LED

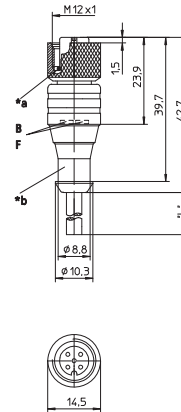

Actuator/sensor cordset, single-ended, M12, 3-, 4-, 5-, 8-, and 12-poles, female 90° connector with LED operation and function indicator with self-locking thread and molded cable.

RKWT/LED

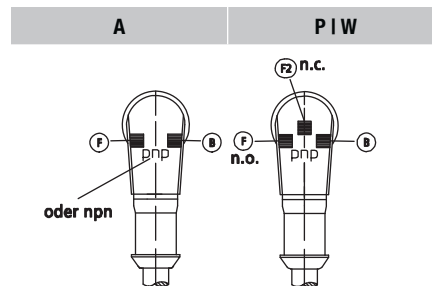
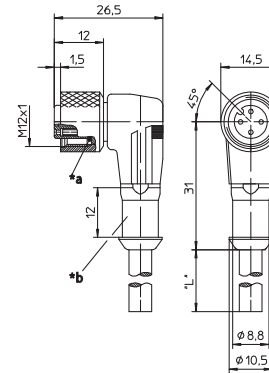

- *a O-Ring
- *b hose mounting
- B operation indicator green
- F function indicator yellow
- F2 function indicator yellow = P, white = W

Pin Assignments

M12 - Male

3 poles

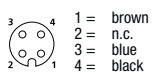

4 poles

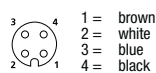

Wiring Diagrams

A npn normally open = yellow-green

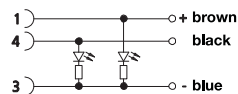

P pnp normally closed/open = yellow-yellow-green

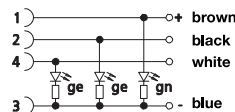

W pnp normally closed/open = yellow-white-green

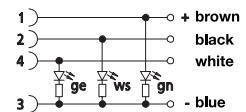

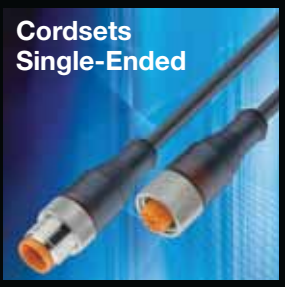

Be Certain with Belden

M12-Round-Plug Connector, Single-Ended Cordsets, According to IEC 61076-2-101

RKT/LED | RKWT/LED

Technical Data

Environmental

Degree of protection IP 67 / NEMA 6P
Operating temperature range -25°C (-13°F) / +80°C (+176°F)

Mechanical

Housing / Molded body TPU, translucent
Insert TPU
Contact CuSn (12 poles: CuZn), pre-nickeled and 0.3 microns gold-plated
Coupling nut CuZn, nickel-plated
O-ring FKM

Electrical

Contact resistance ≤ 5 mΩ
Nominal current at 40°C 4 A
Rated voltage 10-30 V DC
Insulation resistance > 10⁹ Ω

Cable Specifications

Cable No.	Outer Jacket	Conductor Size	Jacket Color	OD
06	PVC	3 x 0.34 mm ²	Orange	.197" (5.0 mm)
07	PVC	4 x 0.75 mm ²	Orange	.197" (5.0 mm)
224	PUR, halogen-free	3 x 0.34 mm ²	Black	.169" (4.3 mm)
225	PUR, halogen-free	4 x 0.34 mm ²	Black	.185" (4.7 mm)
251	PUR, halogen-free welding spark proof	4 x 0.34 mm ²	Orange	.185" (4.7 mm)
260	PUR, halogen-free welding spark proof	3 x 0.34 mm ²	Orange	.177" (4.5 mm)
265	PUR, halogen-free	4 x 0.34 mm ²	Grey	.185" (4.7 mm)

Cordsets
Single-Ended

Part Number	Pins	Outer Jacket	Standard Cable Lengths	Characteristics
RKT/LED A 4-3-06/...M RKWT/LED A 4-3-06/...M	3	PVC	2 M / 5 M / 10 M	
RKT/LED A 4-3-224/...M RKWT/LED A 4-3-224/...M		PUR, halogen-free	2 M / 5 M / 10 M	
RKT/LED A 4-3-260/...M RKWT/LED A 4-3-260/...M		PUR, halogen-free / welding spark proof	2 M / 5 M / 10 M	
RKWT/LED P 4-07/...M	4	PVC	2 M / 5 M / 10 M	
RKWT/LED P 4-225/...M		PUR, halogen-free	2 M / 5 M / 10 M	
RKWT/LED P 4-251/...M		PUR, halogen-free / welding spark proof	2 M / 5 M / 10 M	
RKWT/LED W 4-265/...M	4	PUR, halogen-free	2 M / 5 M / 10 M	

**M12-Round-Plug Connector, Single-Ended Cordsets,
According to IEC 61076-2-101**

RKT/LED | RKWT/LED



3- and 4-Poles (LED)

Actuator/sensor cordset, single-ended, M12, 3- and 4-poles, female straight connector with LED operation and function indicator with self-locking thread and molded cable.

RKT/LED

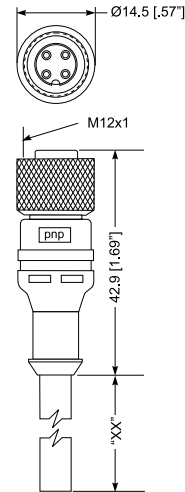

Actuator/sensor cordset, single-ended, M12, 3- and 4poles, female 90° connector with LED operation and function indicator with self-locking thread and molded cable.

RKWT/LED

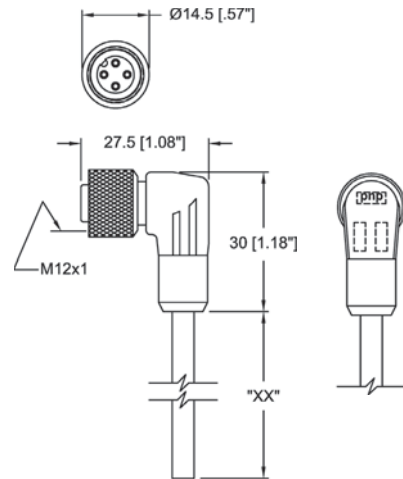

Pin Assignments

M12 - Male

Wiring Diagrams

3 poles

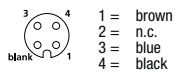

4 poles

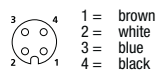

A pnp normally open = yellow-green

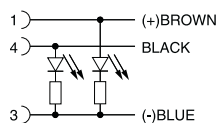

C npn normally open = yellow-green

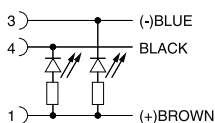

F pnp normally closed/open = yellow-green

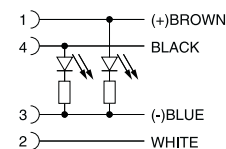

P pnp normally closed/open = yellow-yellow-green

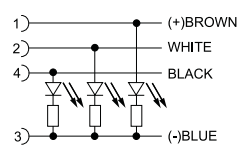

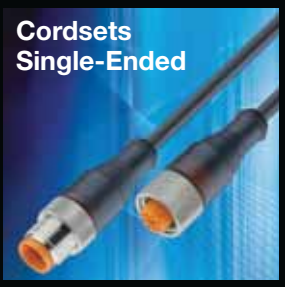

Be Certain with Belden

M12-Round-Plug Connector, Single-Ended Cordsets, According to IEC 61076-2-101 RKT/LED | RKWT/LED

Technical Data

Environmental

Degree of protection IP 67 / NEMA 6P
Operating temperature range -40°C (-40°F) / +90°C (+194°F)

Mechanical

Molded body TPU, translucent
Insert TPU
Contact CuSn, gold over nickel-plated
Coupling nut CuZn, nickel-plated
O-ring FKM

Electrical

Current rating 4 A
Voltage rating 10-30 V DC

Cable Specifications

Cable No.	Outer Jacket	Gauge	Jacket Color	OD
610	PUR	22AWG	Yellow	.190" (4.8 mm)
632	PVC	22AWG	Yellow	.190" (4.8 mm)
633	PVC	22AWG	Yellow	.190" (4.8 mm)
679	PUR	22AWG	Yellow	.190" (4.8 mm)

Part Number	Pins	Outer Jacket	Standard Cable Lengths	Characteristics
RKT/LED A 4-3-610/...M	3	PUR	1M / 2 M / 5 M / 10 M	
RKT/LED A 4-3-632/...M		PVC	1M / 2 M / 5 M / 10 M	
RKT/LED C 4-3-610/...M		PUR	1M / 2 M / 5 M / 10 M	
RKT/LED C 4-3-632/...M		PVC	1M / 2 M / 5 M / 10 M	
RKT/LED F 4-633/...M	4	PVC	1M / 2 M / 5 M / 10 M	
RKT/LED F 4-679/...M		PUR	1M / 2 M / 5 M / 10 M	
		RKWT/LED P 4-633/...M	1M / 2 M / 5 M / 10 M	
		RKWT/LED P 4-679/...M	1M / 2 M / 5 M / 10 M	

**M12-Round-Plug Connector, Single-Ended Cordsets,
According to IEC 61076-2-101**

RSTS



4-, 5-, and 8-Poles (Shielded)

Actuator/sensor cordset, single-ended, M12, 4-, 5-, and 8-poles, male straight connector with threaded joint and molded cable, shielding connecting to knurled screw.

RSTS

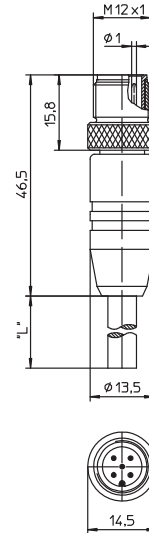

Pin Assignments

M12 - Male

4 poles

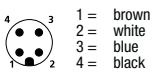

- 1 = brown
- 2 = white
- 3 = blue
- 4 = black

5 poles



- 1 = brown
 - 2 = white
 - 3 = blue
 - 4 = black
 - 5 = grey
- contact 5 leading

8 poles



- 1 = white
- 2 = brown
- 3 = green
- 4 = yellow
- 5 = grey
- 6 = pink
- 7 = blue
- 8 = red



Be Certain with Belden

M12-Round-Plug Connector, Single-Ended Cordsets, According to IEC 61076-2-101 RSTS

Technical Data

Environmental

Degree of protection IP 67 / NEMA 6P
Operating temperature range -25°C (-13°F) / +80°C (+176°F)

Mechanical

Housing / Molded body TPU
Insert TPU
Contact CuSn, pre-nickel and 0.8 microns gold-plated
Coupling nut CuZn, nickel-plated
Shield sleeve CuZn, nickel-plated
O-ring FKM

Electrical

Contact resistance ≤ 5 mΩ
Nominal current at 40°C 4–5 poles 4 A
8 poles 2 A
Nominal voltage 4 poles 240 V
5 poles 60 V
8 poles 30 V
Rated voltage 4 poles 250 V
5 poles 63 V
8 poles 36 V
Test voltage 4 poles 2.0 kV eff. / 60 s
5–8 poles 1.5 kV eff. / 60 s
Insulation resistance > 10⁹ Ω
Pollution degree 3

Cable Specifications

Cable No.	Outer Jacket	Conductor Size	Jacket Color	OD
182	PVC, shielded	4 x 0.34 mm ²	Orange	.217" (5.5 mm)
183	PVC, shielded	5 x 0.34 mm ²	Orange	.236" (6.0 mm)
184	PVC, shielded	8 x 0.25 mm ²	Orange	.260" (6.6 mm)
288	PUR, halogen-free, shielded	4 x 0.34 mm ²	Black	.217" (5.5 mm)
298	PUR, halogen-free, shielded	5 x 0.34 mm ²	Black	.236" (6.0 mm)
299	PUR, halogen-free, shielded	8 x 0.25 mm ²	Black	.260" (6.6 mm)

Cordsets
Single-Ended

Part Number	Pins	Outer Jacket	Standard Cable Lengths	Characteristics
RSTS 4-182/...M	4	PVC	2 M / 5 M / 10 M	
RSTS 4-288/...M		PUR, halogen-free	2 M / 5 M / 10 M	
RSTS 5-183/...M	5	PVC	2 M / 5 M / 10 M	
RSTS 5-298/...M		PUR, halogen-free	2 M / 5 M / 10 M	
RSTS 8-184/...M	8	PVC	2 M / 5 M / 10 M	
RSTS 8-299/...M		PUR, halogen-free	2 M / 5 M / 10 M	

M12-Round-Plug Connector, Single-Ended Cordsets, According to IEC 61076-2-101

RKTS | RKWTH



4-, 5-, and 8-Poles (Shielded)

Actuator/sensor cordset, single-ended, M12, 4-, 5-, and 8-poles, female straight connector, internal threads with threaded joint and molded cable, shielding connecting to knurled nut.

RKTS

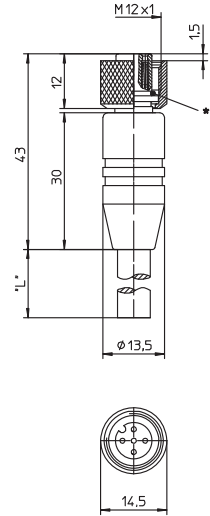

Actuator/sensor cordset, single-ended, M12, 4-, 5-, and 8-poles, female 90 °connector, internal threads with threaded joint and molded cable, shielding connecting to knurled nut.

RKWTH

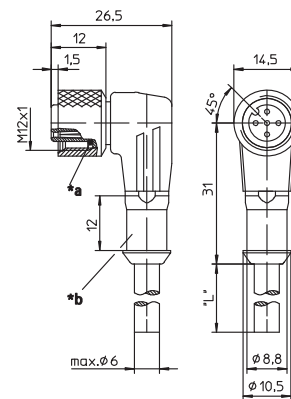

Pin Assignments

M12 - Male

4 poles

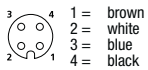

5 poles

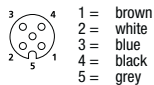

8 poles

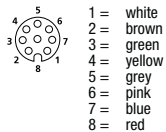



Be Certain with Belden

M12-Round-Plug Connector, Single-Ended Cordsets, According to IEC 61076-2-101 RKTS | RKWTH

Technical Data

Environmental

Degree of protection IP 67 / NEMA 6P
Operating temperature range -25°C (-13°F) / +80°C (+176°F)

Mechanical

Housing / Molded body TPU
Insert TPU
Contact CuSn, pre-nickelated and 0.8 microns gold-plated
Coupling nut CuZn, nickel-plated
Shield sleeve CuZn, nickel-plated
O-ring FKM

Electrical

Contact resistance ≤ 5 mΩ
Nominal current at 40°C 4 A
Nominal voltage 4 poles 240 V
5 poles 60 V
8 poles 30 V
Rated voltage 3-4 poles 250 V
5 poles 63 V
8 poles 36 V
Test voltage 3-4 poles 2.0 kV eff. / 60 s
5-8 poles 1.5 kV eff. / 60 s
Insulation resistance > 10⁹ Ω

Cable Specifications

Cable No.	Outer Jacket	Conductor Size	Jacket Color	OD
182	PVC, shielded	4 x 0.34 mm ²	Orange	.217" (5.5 mm)
183	PVC, shielded	5 x 0.34 mm ²	Orange	.236" (6.0 mm)
184	PVC, shielded	8 x 0.25 mm ²	Orange	.260" (6.6 mm)
288	PUR, halogen-free, shielded	4 x 0.34 mm ²	Black	.217" (5.5 mm)
298	PUR, halogen-free, shielded	5 x 0.34 mm ²	Black	.236" (6.0 mm)
299	PUR, halogen-free, shielded	8 x 0.25 mm ²	Black	.260" (6.6 mm)

RKWTH (8-pole version)

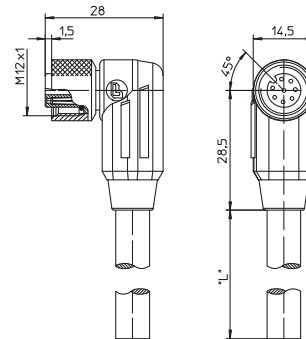

Part Number	Part Number	Pins	Outer Jacket	Standard Cable Lengths	Characteristics
Female Straight	Female 90°				
RKTS 4-182/...M	RKWTH 4-182/...M	4	PVC	2 M / 5 M / 10 M	
RKTS 4-288/...M	RKWTH 4-288/...M		PUR, halogen-free	2 M / 5 M / 10 M	
RKTS 5-183/...M		5	PVC	2 M / 5 M / 10 M	
RKTS 5-298/...M	RKWTH 5-298/...M		PUR, halogen-free	2 M / 5 M / 10 M	
RKTS 8-184/...M		8	PVC	2 M / 5 M / 10 M	
RKTS 8-299/...M	RKWTH 8-299/...M		PUR, halogen-free	2 M / 5 M / 10 M	

**M12-Round-Plug Connector, Single-Ended Cordsets,
According to IEC 61076-2-101**

PRST



4-Poles (Stainless Steel)

Actuator/sensor cordset, single-ended, M12, 4-poles, male straight connector with threaded joint and molded cable, hexagon screw in stainless steel.

— especially designed for use in food processing equipment applications —

PRST

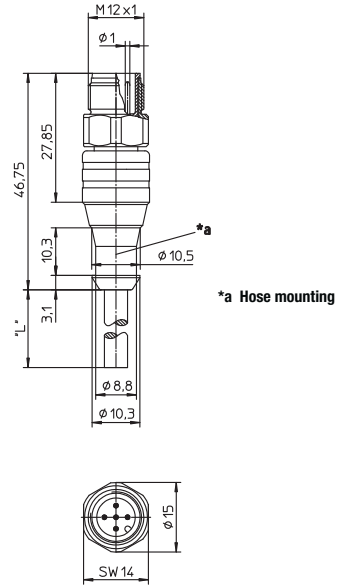

Pin Assignments

M12 - Male

4 poles

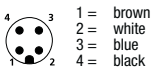

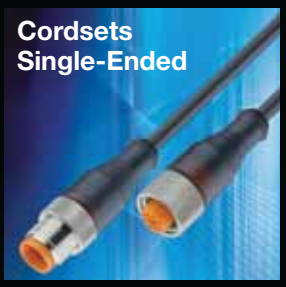

Be Certain with Belden

M12-Round-Plug Connector, Single-Ended Cordsets, According to IEC 61076-2-101 PRST

Technical Data

Environmental

Degree of protection IP 67 / IP 69K / NEMA 6P
 Operating temperature range -25°C (-13°F) / +70°C (+158°F)

Mechanical

Housing / Molded body TPU
 Insert TPU
 Contact CuSn, pre-nickeled and 0.3 microns gold-plated
 Coupling nut stainless steel

Electrical

Contact resistance $\leq 5 \text{ m}\Omega$
 Nominal current at 40°C 4 A
 Nominal voltage 240 V
 Rated voltage 250 V
 Test voltage 2.0 kV eff. / 60 s
 Insulation resistance $> 10^9 \Omega$
 Pollution degree 3

Cable Specifications

Cable No.	Outer Jacket	Conductor Size	Jacket Color	OD
07	PVC	4 x 0.75 mm ²	Orange	.197" (5.0 mm)

Part Number	Pins	Outer Jacket	Standard Cable Lengths	Characteristics
PRST 4-07/...M	4	PVC	5 M / 10 M / 25 M	  

**M12-Round-Plug Connector, Single-Ended Cordsets,
According to IEC 61076-2-101**

PRKT | PRKWT



4- and 5-Poles (Stainless Steel)

Actuator/sensor cordset, single-ended, M12, 4- and 5-poles, female straight connector, internal threads with threaded joint and molded cable, hexagon screw in stainless steel.

– especially designed for use in food processing equipment applications –

PRKT

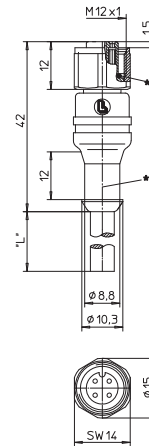

*a O-ring
b Hose mounting



Actuator/sensor cordset, single-ended, M12, 4- and 5-poles, female 90° connector, internal threads with threaded joint and molded cable, hexagon screw in stainless steel.

– especially designed for use in food processing equipment applications –

PRKWT

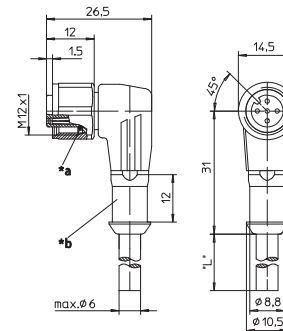

*a O-ring
b Hose mounting

Pin Assignments

M12 - Male

4 poles

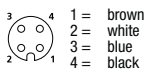

5 poles

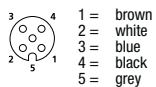

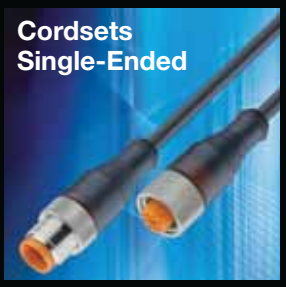

Be Certain with Belden

M12-Round-Plug Connector, Single-Ended Cordsets, According to IEC 61076-2-101
PRKT | PRKWT

Technical Data

Environmental

Degree of protection IP 67 / 69K / NEMA 6P
Operating temperature range -25°C (-13°F) / +70°C (+158°F)

Mechanical

Housing / Molded body TPU
Insert TPU
Contact CuSn, pre-nickel and 0.3 microns gold-plated
Coupling nut stainless steel

Electrical

Contact resistance ≤ 5 mΩ
Nominal current at 40°C 4 A
Nominal voltage 4 poles 240 V
5 poles 60 V
Rated voltage 4 poles 250 V
5 poles 63 V
Test voltage 4 poles 2.0 kV eff. / 60 s
5 poles 1.5 kV eff. / 60 s
Insulation resistance > 10⁹ Ω
Pollution degree 3

Cable Specifications

Cable No.	Outer Jacket	Conductor Size	Jacket Color	OD
07	PVC	4 x 0.75 mm ²	Orange	.197" (5.0 mm)
56	PVC	5 x 0.34 mm ²	Orange	.224" (5.7 mm)

Part Number	Pins	Outer Jacket	Standard Cable Lengths	Characteristics
PRKT 4-07/...M	4	PVC	5 M / 10 M / 25 M	
PRKT 5-56/...M	5	PVC	5 M / 10 M / 25 M	

**M12-Round-Plug Connector, Single-Ended Cordsets,
According to IEC 61076-2-101**

PRKWT/LED



4-Poles (Stainless Steel / LED)

Actuator/sensor cordset, single-ended, M12, 4-poles, female 90° connector, with LED operation and function indicator, self locking threaded joint and molded cable, hexagon screw in stainless steel.

– especially designed for use in food processing equipment applications –

PRKWT/LED

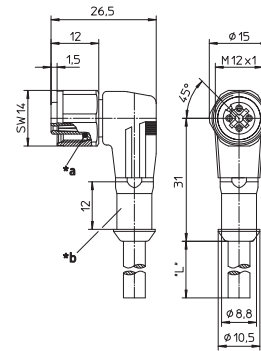

*a O-ring
b Hose mounting

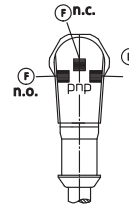

Pin Assignments

M12 - Male

4 poles

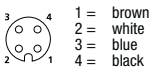

Wiring Diagrams

P pnp normally closed/open = yellow-yellow-green

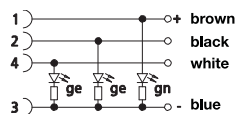



Be Certain with Belden

M12-Round-Plug Connector, Single-Ended Cordsets, According to IEC 61076-2-101 PRKWT/LED

Technical Data

Environmental

Degree of protection IP 67 / 69K / NEMA 6P
 Operating temperature range -25°C (-13°F) / +70°C (+158°F)

Mechanical

Housing / Molded body TPU
 Insert TPU
 Contact CuSn, pre-nickel and 0.3 microns gold-plated
 Coupling nut stainless steel
 O-ring EPDM

Electrical

Contact resistance $\leq 5 \text{ m}\Omega$
 Nominal current at 40°C 4 A
 Nominal voltage 10–30 V DC
 Rated voltage 32 V
 Insulation resistance $> 10^9 \Omega$
 Pollution degree 3

Cable Specifications

Cable No.	Outer Jacket	Conductor Size	Jacket Color	OD
07	PVC	4 x 0.75 mm ²	Orange	.197" (5.0 mm)

Part Number	Pins	Outer Jacket	Standard Cable Lengths	Characteristics
PRKWT/LED P 4-07/...M	4	PVC	5 M / 10 M / 25 M	  

M 1/2"-20-Round-Plug Connector, Single-Ended Cordsets

RST 3U | RKT 3U



3-Poles

Actuator/sensor cordsets, single ended, 1/2" UNF, 3-poles, C-coding male straight connector, external threads with threaded joint and molded cable, IEC color code.

RST 3U

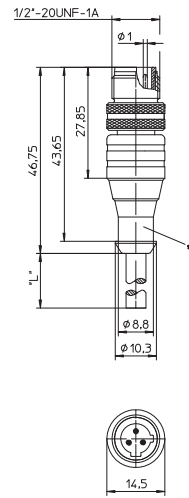

Actuator/sensor cordsets, single ended, 1/2" UNF, 3-poles, C-coding female straight connector, external threads with threaded joint and molded cable, IEC color code.

RKT 3U

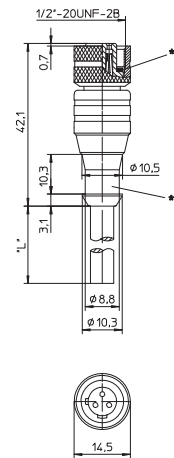

Pin Assignments

1/2"-20 - Male / Female

3 poles

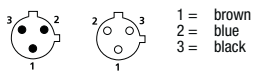



Be Certain with Belden

M 1/2"-20-Round-Plug Connector, Single-Ended Cordsets
RST 3U | RKT 3U

Technical Data

Environmental

Degree of protection IP 67 / NEMA 6P
Operating temperature range -25°C (-13°F) / +80°C (+176°F)

Mechanical

Housing / Molded body TPU
Insert TPU
Contact CuSn, pre-nickel and 0.8 microns gold-plated
Coupling nut CuZn, nickel-plated

Electrical

Contact resistance $\leq 5 \text{ m}\Omega$
Nominal current at 40°C 4 A
Nominal voltage 240 V
Rated voltage 250 V
Test voltage 2.0 kV eff. / 60 s
Insulation resistance $> 10^9 \Omega$
Pollution degree 3

Cable Specifications

Cable No.	Outer Jacket	Conductor Size	Jacket Color	OD
226	PUR, halogen-free	3 x 0.50mm ²	Black	.181" (4.6 mm)

Part Number	Pins	Outer Jacket	Standard Cable Lengths	Characteristics
RST 3U-226/...M RKT 3U-226/...M	3	PUR, halogen-free	5 M	

1/2"-20-Round-Plug Connector, Single-Ended Cordsets, Automotive Color Code

RST...U | RKT...U



3, 4-, and 5-Poles

1/2"-20 actuator/sensor cordsets, single-ended, 3-, 4- and 5-Poles, male straight connector, external threads, dual keyway, 18 and 22 gauge, Automotive color code.

RST 5U

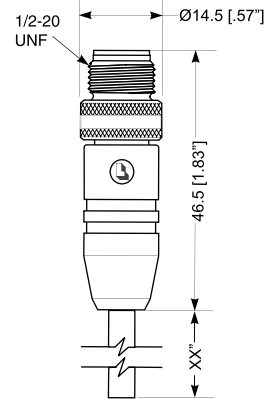

1/2"-20 actuator/sensor cordsets, single-ended, 3-, 4- and 5-Poles, female straight connector, external threads, dual keyway, 18 and 22 gauge, Automotive color code.

RKT 5U

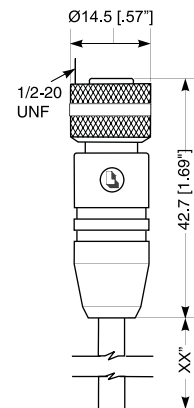

Pin Assignments

1/2"-20 - Male / Female

3 poles

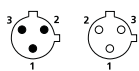

1 = green
2 = red/black
3 = red/white

4 poles

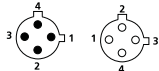

1 = red/black
2 = red/white
3 = red
4 = green

5 poles

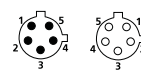

1 = red/white tr.
2 = red
3 = green
4 = red/yel tr.
5 = red/blk tr.

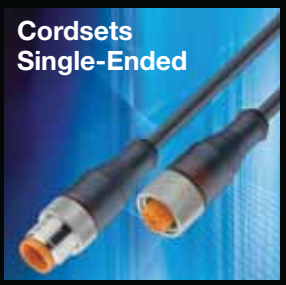

Be Certain with Belden

1/2"-20-Round-Plug Connector, Single-Ended Cordsets, Automotive Color Code RST ...U | RKT ...U

Technical Data

Environmental

Degree of protection IP 67 / NEMA 6P
 Operating temperature range -40°C (-40°F) / +90°C (+194°F)

Mechanical

Housing / Molded body TPU, yellow
 Insert TPU, yellow
 Contact CuZn, gold over nickel plated
 Coupling nut CuZn, nickel-plated

Electrical

Current rating 4 A
 Voltage rating 250 V

Cable Specifications - Automotive Color Code

Cable No.	Outer Jacket	Gauge	Conductor Size	Jacket Color	OD
688	PVC	18AWG	3 x 0.75mm ²	Yellow	.290" (7.4 mm)
689	PVC	18AWG	4 x 0.75mm ²	Yellow	.290" (7.4 mm)
755	TPE	18AWG	5 x 0.75mm ²	Yellow	.333" (8.5 mm)
618	PVC	22AWG	3 x 0.34mm ²	Yellow	.180" (4.6 mm)
674	PVC	22AWG	4 x 0.34mm ²	Yellow	.190" (4.8 mm)
673	PVC	22AWG	5 x 0.34mm ²	Yellow	.210" (5.3 mm)
664	PUR	22AWG	3 x 0.34mm ²	Yellow	.190" (4.8 mm)

Part Number	Pins	Outer Jacket	Standard Cable Lengths	Characteristics
RST 3U-688/...F RKT 3U-688/...F	3	PVC	6 F / 12 F / 15 F / 20 F	
RST 4U-689/...F RKT 4U-689/...F	4	PVC	6 F / 12 F / 15 F / 20 F	
RST 5U-755/...F RKT 5U-755/...F	5	TPE	6 F / 12 F / 15 F / 20 F	
RST 3U-618/...F RKT 3U-618/...F	3	PVC	6 F / 12 F / 15 F / 20 F	
RST 4U-674/...F RKT 4U-674/...F	4	PVC	6 F / 12 F / 15 F / 20 F	
RST 5U-673/...F RKT 5U-673/...F	5	PVC	6 F / 12 F / 15 F / 20 F	
RST 3U-664/...F RKT 3U-664/...F	3	PUR	6 F / 12 F / 15 F / 20 F	

1/2"-20-Round-Plug Connector, Single-Ended Cordsets, Automotive Color Code

RKWT...U



3, 4-, and 5-Poles

1/2"-20 actuator/sensor cordsets, single-ended, 3-, 4- and 5-Poles, female 90° connector, external threads, dual keyway, 18 and 22 gauge, Automotive color code.

RKWT 5U

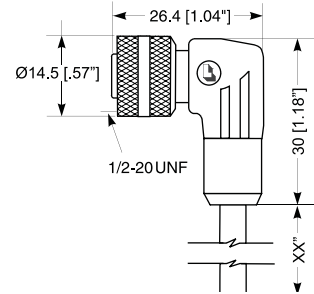

Pin Assignments

1/2"-20 - Male / Female

3 poles

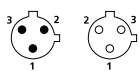

- 1 = green
- 2 = red/black
- 3 = red/white

4 poles

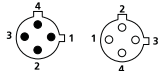

- 1 = red/black
- 2 = red/white
- 3 = red
- 4 = green

5 poles

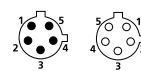

- 1 = red/white tr.
- 2 = red
- 3 = green
- 4 = red/yel tr.
- 5 = red/blk tr.

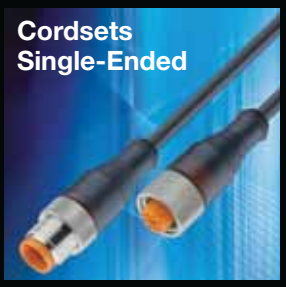

Be Certain with Belden

1/2"-20-Round-Plug Connector, Single-Ended Cordsets, Automotive Color Code RST ...U | RKT ...U | RKWT ...U

Technical Data

Environmental

Degree of protection IP 67 / NEMA 6P
Operating temperature range -40°C (-40°F) / +90°C (+194°F)

Mechanical

Housing / Molded body TPU, yellow
Insert TPU, yellow
Contact CuZn, gold over nickel plated
Coupling nut CuZn, nickel-plated

Electrical

Current rating 4 A
Voltage rating 250 V

Cable Specifications - Automotive Color Code

Cable No.	Outer Jacket	Gauge	Conductor Size	Jacket Color	OD
688	PVC	18AWG	3 x 0.75mm ²	Yellow	.290" (7.4 mm)
689	PVC	18AWG	4 x 0.75mm ²	Yellow	.290" (7.4 mm)
755	TPE	18AWG	5 x 0.75mm ²	Yellow	.333" (8.5 mm)
618	PVC	22AWG	3 x 0.34mm ²	Yellow	.180" (4.6 mm)
674	PVC	22AWG	4 x 0.34mm ²	Yellow	.190" (4.8 mm)
673	PVC	22AWG	5 x 0.34mm ²	Yellow	.210" (5.3 mm)
664	PUR	22AWG	3 x 0.34mm ²	Yellow	.190" (4.8 mm)

Part Number	Pins	Outer Jacket	Standard Cable Lengths	Characteristics
RKWT 3U-688/...F	3	PVC	6 F / 12 F / 15 F / 20 F	
RKWT 4U-689/...F	4	PVC	6 F / 12 F / 15 F / 20 F	
RKWT 5U-755/...F	5	TPE	6 F / 12 F / 15 F / 20 F	
RKWT 3U-618/...F	3	PVC	6 F / 12 F / 15 F / 20 F	
RKWT 4U-674/...F	4	PVC	6 F / 12 F / 15 F / 20 F	
RKWT 5U-673/...F	5	PVC	6 F / 12 F / 15 F / 20 F	
RKWT 3U-664/...F	3	PUR	6 F / 12 F / 15 F / 20 F	

1/2"-20-Round-Plug Connector, Single-Ended Cordsets, US Color Code

RST...U | RKT...U



3-Poles

1/2"-20 actuator/sensor-cordsets, single ended, 3-poles, male straight connector, external threads, dual keyway, 18 gauge, US color code.

RST 3U

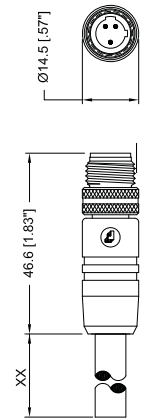

1/2"-20 actuator/sensor-cordsets, single ended, 3-poles, female straight connector, internal threads, dual keyway, 18 gauge, US color code.

RKT 3U

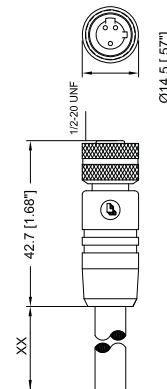

Pin Assignments

1/2"-20 - Male / Female

3 poles

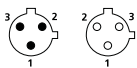

1 = green
2 = black
3 = white

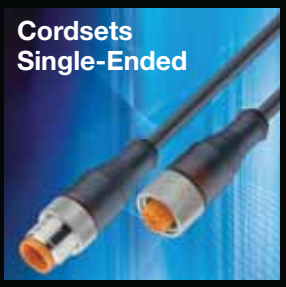

Be Certain with Belden

1/2"-20-Round-Plug Connector, Single-Ended Cordsets, US Color Code
RST ...U | RKT ...U

Technical Data

Environmental

Degree of protection IP 67 / NEMA 6P
Operating temperature range -40°C (-40°F) / +90°C (+194°F)

Mechanical

Housing / Molded body TPU, yellow
Insert TPU, yellow
Contact CuZn, gold over nickel plated
Coupling nut CuZn, nickel-plated

Electrical

Current rating 4 A
Voltage rating 250 V

Cable Specifications - US Color Code

Cable No.	Outer Jacket	Gauge	Conductor Size	Jacket Color	OD
619	CPE	18AWG	3 x 0.75mm ²	Yellow	.370" (9.4 mm)

Part Number	Pins	Outer Jacket	Standard Cable Lengths	Characteristics
RST 3U-619/...F RKT 3U-619/...F	3	CPE	6 F / 12 F / 15 F / 20 F	



**1/2"-20-Round-Plug Connector, Single-Ended Cordsets,
US Color Code**

RKWT...U



3-Poles

1/2"-20 actuator/sensor-cordsets, single ended,
3-poles, female 90° connector, internal threads,
dual keyway, 18 gauge, US color code.

RKWT 3U

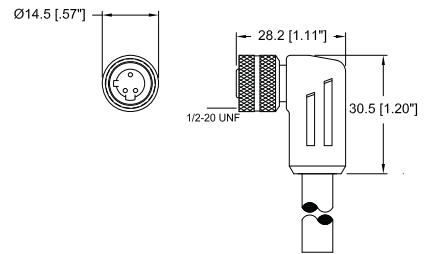

Pin Assignments

1/2"-20 - Male / Female

3 poles

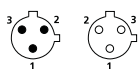

1 = green
2 = black
3 = white



Be Certain with Belden

1/2"-20-Round-Plug Connector, Single-Ended Cordsets, US Color Code
RKWT ...U

Technical Data

Environmental

Degree of protection IP 67 / NEMA 6P
Operating temperature range -40°C (-40°F) / +90°C (+194°F)

Mechanical

Housing / Molded body TPU, yellow
Insert TPU, yellow
Contact CuZn, gold over nickel plated
Coupling nut CuZn, nickel-plated

Electrical

Current rating 4 A
Voltage rating 250 V

Cable Specifications - US Color Code

Cable No.	Outer Jacket	Gauge	Conductor Size	Jacket Color	OD
619	CPE	18AWG	3 x 0.75mm ²	Yellow	.370" (9.4 mm)

Part Number	Pins	Outer Jacket	Standard Cable Lengths	Characteristics
RKWT 3U-619/...F	3	PVC	6 F / 12 F / 15 F / 20 F	  

Mini, 7/8"-Round-Plug Connector, Single-Ended Cordsets, US Color Code

RS 201...601A | RK 20...60A



2-, 3-, 4-, 5-, and 6-Poles

Mini, 7/8" single-ended cordsets, male straight, 2-, 3-, 4-, 5-, and 6-poles with internal threads and molded cable, US color code.

RS

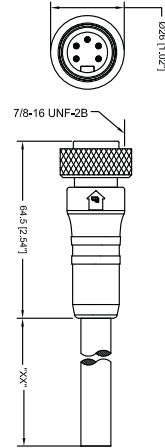

Mini, 7/8" single-ended cordsets, female straight, 2-, 3-, 4-, 5-, and 6-poles with internal threads and molded cable, US color code.

RK

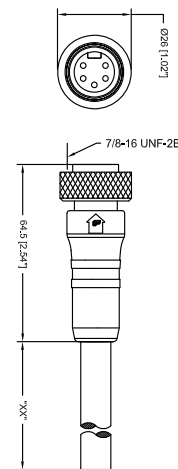

Pin Assignments

Mini, 7/8" - Male / Female

2 poles

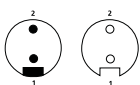

1 = white
2 = black

3 poles

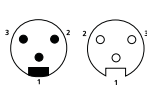

1 = green
2 = black
3 = white

4 poles

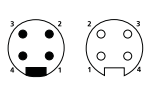

1 = black
2 = white
3 = red
4 = green

5 poles

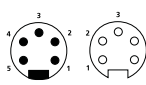

1 = white
2 = red
3 = green
4 = orange
5 = black

6 poles

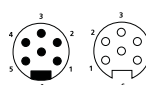

1 = white
2 = red
3 = green
4 = orange
5 = black
6 = blue



Be Certain with Belden

Mini, 7/8"-Round-Plug Connector, Single-Ended Cordsets, US Color Code RS 201...601A | RK 20...60A

Technical Data

Environmental

Degree of protection IP 67 / NEMA 6P
Operating temperature range -40°C (-40°F) / +90°C (194°F)

Mechanical

Housing / Molded body TPU, yellow
Insert TPU, yellow
Contact CuZn, gold over silver plated
Coupling nut Aluminum, anodized black

Electrical

Current rating 2 pole: 12 A
3-6 pole: 8 A
Voltage rating 600 V

Cable Specifications - US Color Code

Cable No.	Outer Jacket	Gauge	Jacket Color	OD	Temperature Rating	Agency Approvals
678	PVC	16AWG	Yellow	.375" (9.5 mm)	-40°C (-40°F) to +105°C (221°F)	UL: STOW / CSA: ST0
619	CPE	18AWG	Yellow	.370" (9.4 mm)	-40°C (-40°F) to +90°C (194°F)	UL: S00W / CSA: S0W
738	TPE	16AWG	Yellow	.390" (9.9 mm)	-50°C (-58°F) to +105°C (221°F)	UL: SE00W / CSA: ST00W
739	TPE	16AWG	Yellow	.415" (10.5 mm)	-50°C (-58°F) to +105°C (221°F)	UL: SE00W / CSA: ST00W
777	TPE	16AWG	Yellow	.495" (12.6 mm)	-50°C (-58°F) to +105°C (221°F)	UL: SE00W / CSA: ST00W
697	PVC	18AWG	Yellow	.502" (12.8 mm)	-40°C (-40°F) to +105°C (221°F)	UL: ST0W / CSA: ST00

Part Number	Pins	Outer Jacket	Standard Cable Lengths	Characteristics
RS 201-678/...F RK 20-678/...F	2	PVC	6 F / 12 F / 15 F / 20 F / 30 F	
RS 301-619/...F RK 30-619/...F	3	CPE	6 F / 12 F / 15 F / 20 F / 30 F	
RS 301-738/...F RK 30-738/...F		TPE	6 F / 12 F / 15 F / 20 F / 30 F	
RS 401-739/...F RK 40-739/...F	4	TPE	6 F / 12 F / 15 F / 20 F / 30 F	
RS 501-777/...F RK 50-777/...F	5	TPE	6 F / 12 F / 15 F / 20 F / 30 F	
RS 601A-697/...F RK 60A-697/...F	6	PVC	6 F / 12 F / 15 F / 20 F / 30 F	

Mini, 7/8"-Round-Plug Connector, Single-Ended Cordsets, US Color Code

RSW 201...601A | RKW 20...60A



2-, 3-, 4-, 5-, and 6-Poles

Mini, 7/8" single-ended cordsets, male 90°, 2-, 3-, 4-, 5-, and 6-poles with internal threads and molded cable, US color code.

RSW

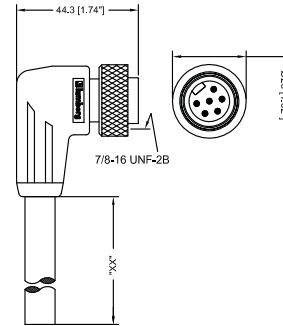

Mini, 7/8" single-ended cordsets, female 90°, 2-, 3-, 4-, 5-, and 6-poles with internal threads and molded cable, US color code.

RKW

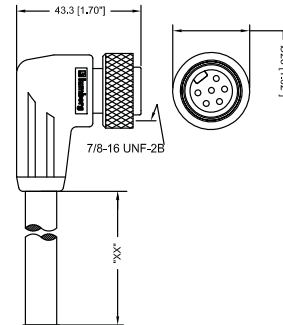

Pin Assignments

Mini, 7/8" - Male / Female

2 poles

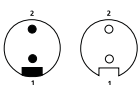

1 = white
2 = black

3 poles

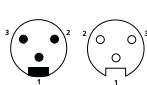

1 = green
2 = black
3 = white

4 poles

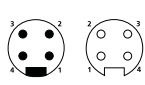

1 = black
2 = white
3 = red
4 = green

5 poles

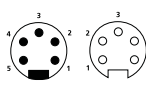

1 = white
2 = red
3 = green
4 = orange
5 = black

6 poles

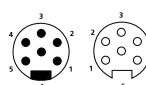

1 = white
2 = red
3 = green
4 = orange
5 = black
6 = blue

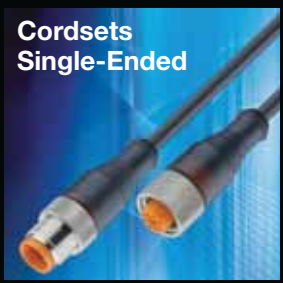

Be Certain with Belden

Mini, 7/8"-Round-Plug Connector, Single-Ended Cordsets, US Color Code RSW 201...601A | RKW 20...60A

Technical Data

Environmental

Degree of protection IP 67 / NEMA 6P
Operating temperature range -40°C (-40°F) / +90°C (194°F)

Mechanical

Housing / Molded body TPU, yellow
Insert TPU, yellow
Contact CuZn, gold over silver plated
Coupling nut Aluminum, anodized black

Electrical

Current rating 2 pole: 12 A
3-6 pole: 8 A
Voltage rating 600 V

Cable Specifications - US Color Code

Cable No.	Outer Jacket	Gauge	Jacket Color	OD	Temperature Rating	Agency Approvals
678	PVC	16AWG	Yellow	.375" (9.5 mm)	-40°C (-40°F) to +105°C (221°F)	UL: STOW / CSA: ST0
619	CPE	18AWG	Yellow	.370" (9.4 mm)	-40°C (-40°F) to +90°C (194°F)	UL: S00W / CSA: S0W
738	TPE	16AWG	Yellow	.390" (9.9 mm)	-50°C (-58°F) to +105°C (221°F)	UL: SE00W / CSA: ST00W
739	TPE	16AWG	Yellow	.415" (10.5 mm)	-50°C (-58°F) to +105°C (221°F)	UL: SE00W / CSA: ST00W
777	TPE	16AWG	Yellow	.495" (12.6 mm)	-50°C (-58°F) to +105°C (221°F)	UL: SE00W / CSA: ST00W
697	PVC	18AWG	Yellow	.502" (12.8 mm)	-40°C (-40°F) to +105°C (221°F)	UL: ST0W / CSA: ST00

Part Number	Pins	Outer Jacket	Standard Cable Lengths	Characteristics
RSW 201-678/...F RKW 20-678/...F	2	PVC	6 F / 12 F / 15 F / 20 F / 30 F	
RSW 301-619/...F RKW 30-619/...F	3	CPE	6 F / 12 F / 15 F / 20 F / 30 F	
RSW 301-738/...F RKW 30-738/...F		TPE	6 F / 12 F / 15 F / 20 F / 30 F	
RSW 401-739/...F RKW 40-739/...F	4	TPE	6 F / 12 F / 15 F / 20 F / 30 F	
RSW 501-777/...F RKW 50-777/...F	5	TPE	6 F / 12 F / 15 F / 20 F / 30 F	
RSW 601A-697/...F RKW 60A-697/...F	6	PVC	6 F / 12 F / 15 F / 20 F / 30 F	

Mini, 7/8"-Round-Plug Connector, Single-Ended Cordsets, Automotive Color Code

RS 301...501 | RK 30...50



3- and 5-Poles

Mini, 7/8" single-ended cordsets, male straight, 3- and 5-poles with internal threads and molded cable, US color code.

RS

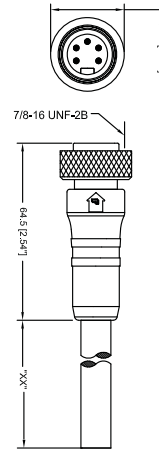

Mini, 7/8" single-ended cordsets, female straight, 3- and 5-poles with internal threads and molded cable, US color code.

RK

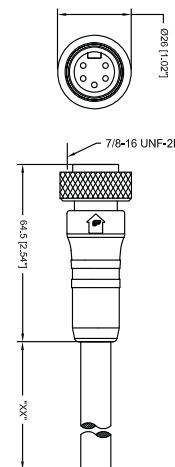

Pin Assignments

Mini, 7/8" - Male / Female

3 poles

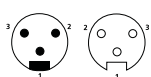

- 1 = green
- 2 = red w/black tr.
- 3 = red w/white tr.

5 poles (742)

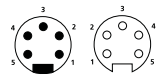

- 1 = red w/white tr.
- 2 = red
- 3 = green
- 4 = red w/orange tr.
- 5 = red w/black tr.

5 poles (755)

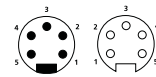

- 1 = red w/white tr.
- 2 = red
- 3 = green
- 4 = red w/yellow tr.
- 5 = red w/black tr.

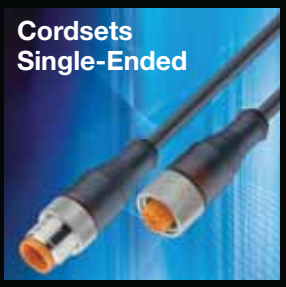

Be Certain with Belden

Mini, 7/8"-Round-Plug Connector, Single-Ended Cordsets, Automotive Color Code
RS 301...501 | RK 30...50

Technical Data

Environmental

Degree of protection IP 67 / NEMA 6P
Operating temperature range -40°C (-40°F) / +90°C (194°F)

Mechanical













Housing / Molded body TPU, yellow
Insert TPU, yellow
Contact CuZn, gold over silver plated
Coupling nut Aluminum, anodized black

Electrical

Current rating 741/742: 8 A
755: 5.6 A
Voltage rating 741/742: 600 V
755: 300 V

Cable Specifications - Automotive Color Code

Cable No.	Outer Jacket	Gauge	Jacket Color	OD	Temperature Rating	Agency Approvals
741	TPE	16AWG	Yellow	.390" (9.9 mm)	-40°C (-40°F) to +105°C (221°F)	UL: SE00W / CSA: ST00W
742	TPE	16AWG	Yellow	.495" (12.6 mm)	-40°C (-40°F) to +105°C (221°F)	UL: SE00W / CSA: ST00W
755	TPE	18AWG	Yellow	.333" (8.5 mm)	-40°C (-40°F) to +90°C (194°F)	UL: PLTC / CSA: AWM I/II, A/B

Part Number	Pins	Outer Jacket	Standard Cable Lengths	Characteristics
RS 301-741/...F RK 30-741/...F	3	TPE	6 F / 12 F / 15 F / 20 F / 30 F	   
RS 501-742/...F RK 50-742/...F	5	TPE	6 F / 12 F / 15 F / 20 F / 30 F	   
RS 501-755/...F RK 50-755/...F	5	TPE	6 F / 12 F / 15 F / 20 F / 30 F	   

Mini, 7/8"-Round-Plug Connector, Single-Ended Cordsets, Automotive Color Code

RSW 301...501 | RKW 30...50



3- and 5-Poles

Mini, 7/8" single-ended cordsets, male 90°, 3- and 5-poles with internal threads and molded cable, US color code.

RSW

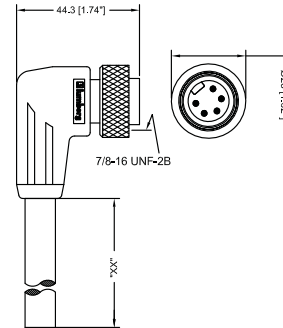

Mini, 7/8" single-ended cordsets, female 90°, 3- and 5-poles with internal threads and molded cable, US color code.

RKW

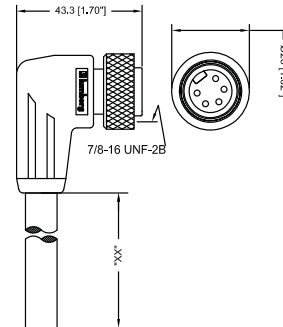

Pin Assignments

Mini, 7/8" - Male / Female

3 poles

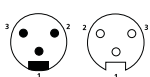

- 1 = green
- 2 = red w/black tr.
- 3 = red w/white tr.

5 poles (742)

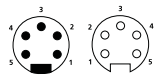

- 1 = red w/white tr.
- 2 = red
- 3 = green
- 4 = red w/orange tr.
- 5 = red w/black tr.

5 poles (755)

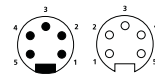

- 1 = red w/white tr.
- 2 = red
- 3 = green
- 4 = red w/yellow tr.
- 5 = red w/black tr.



Be Certain with Belden

Mini, 7/8"-Round-Plug Connector, Single-Ended Cordsets, Automotive Color Code
RSW 301...501 | RKW 30...50

Technical Data

Environmental

Degree of protection IP 67 / NEMA 6P
Operating temperature range -40°C (-40°F) / +90°C (194°F)

Mechanical













Housing / Molded body TPU, yellow
Insert TPU, yellow
Contact CuZn, gold over silver plated
Coupling nut Aluminum, anodized black

Electrical

Current rating 741/742: 8 A
755: 5.6 A
Voltage rating 741/742: 600 V
755: 300 V

Cable Specifications - Automotive Color Code

Cable No.	Outer Jacket	Gauge	Jacket Color	OD	Temperature Rating	Agency Approvals
741	TPE	16AWG	Yellow	.390" (9.9 mm)	-40°C (-40°F) to +105°C (221°F)	UL: SE00W / CSA: ST00W
742	TPE	16AWG	Yellow	.495" (12.6 mm)	-40°C (-40°F) to +105°C (221°F)	UL: SE00W / CSA: ST00W
755	TPE	18AWG	Yellow	.333" (8.5 mm)	-40°C (-40°F) to +90°C (194°F)	UL: PLTC / CSA: AWM I/II, A/B

Part Number	Pins	Outer Jacket	Standard Cable Lengths	Characteristics
RSW 301-741/...F RKW 30-741/...F	3	TPE	6 F / 12 F / 15 F / 20 F / 30 F	   
RSW 501-742/...F RKW 50-742/...F	5	TPE	6 F / 12 F / 15 F / 20 F / 30 F	   
RSW 501-755/...F RKW 50-755/...F	5	TPE	6 F / 12 F / 15 F / 20 F / 30 F	   

Mini, 7/8"-Round-Plug Connector, Single-Ended Cordsets, IEC Color Code

RS 20...50 | RK 20...50



2-, 3-, 4-, and 5-Poles

Mini, 7/8" single-ended cordsets, male straight, 2-, 3-, 4-, and 5-poles with external threads and molded cable, IEC color code.

RS

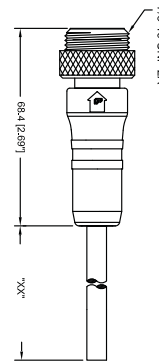
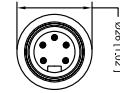

Mini, 7/8" single-ended cordsets, female straight, 2-, 3-, 4-, and 5-poles with internal threads and molded cable, IEC color code.

RK

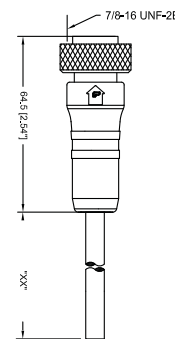
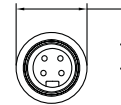

Pin Assignments

Mini, 7/8" - Male / Female

2 poles

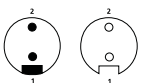

1 = brown
2 = blue

3 poles

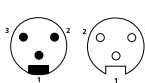

1 = green
2 = brown
3 = blue

4 poles

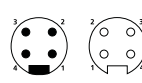

1 = black
2 = blue
3 = brown
4 = white

5 poles

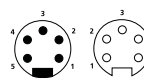

1 = black
2 = blue
3 = yellow w/green tr.
4 = brown
5 = white

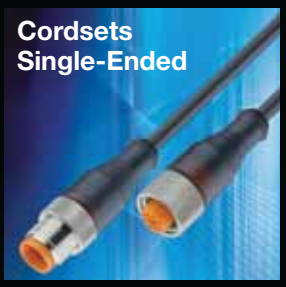

Be Certain with Belden

Mini, 7/8"-Round-Plug Connector, Single-Ended Cordsets, IEC Color Code RS 20...50 | RK 20...50

Technical Data

Environmental

Degree of protection IP 67 / NEMA 6P
Operating temperature range -40°C (-40°F) / +90°C (194°F)

Mechanical

Housing / Molded body TPU, yellow
Insert TPU, yellow
Contact CuZn, gold over silver plated
Coupling nut Aluminum, anodized black

Electrical

Current rating 2-3 pole: 8 A
4-5 pole: 5.6 A
Voltage rating 300 V

Cable Specifications - IEC Color Code

Cable No.	Outer Jacket	Gauge	Jacket Color	OD	Temperature Rating	Agency Approvals
603	PVC	18AWG	Yellow	.290" (7.4 mm)	-40°C (-40°F) to +105°C (221°F)	UL: AWM 2661 / CSA: AWM I/II A/B
731	TPE	18AWG	Yellow	.284" (7.2 mm)	-50°C (-58°F) to +90°C (194°F)	UL: PLTC / CSA: AWM I/II A/B
645	PUR	18AWG	Yellow	.220" (5.6 mm)	-40°C (-40°F) to +80°C (176°F)	UL: AWM 20233 / CSA: AWM I/II A/B
637	TPE	18AWG	Yellow	.280" (7.1 mm)	-25°C (-40°F) to +105°C (221°F)	UL: PLTC / CSA: AWM I/II A/B
602	PUR	18AWG	Yellow	.230" (5.8 mm)	-40°C (-40°F) to +80°C (176°F)	UL: AWM 20233 / CSA: AWM I/II A/B
794	TPE	18AWG	Yellow	.304" (7.7 mm)	-50°C (-58°F) to +90°C (194°F)	UL: PLTC / CSA: AWM I/II A/B

Part Number	Pins	Outer Jacket	Standard Cable Lengths	Characteristics
RS 20-603/...M RK 20-603/...M	2	PVC	2 M / 5 M / 10 M	
RS 30-731/...F RK 30-731/...F	3	TPE	6 F / 12 F / 15 F / 20 F / 30 F	
RS 30-645/...M RK 30-645/...M		PUR	2 M / 5 M / 10 M	
RS 40-637/...F RK 40-637/...F	4	TPE	6 F / 12 F / 15 F / 20 F / 30 F	
RS 40-602/...M RK 40-602/...M		PUR	2 M / 5 M / 10 M	
RS 50-794/...F RK 50-794/...F	5	TPE	6 F / 12 F / 15 F / 20 F / 30 F	

Mini, 7/8"-Round-Plug Connector, Single-Ended Cordsets, IEC Color Code

RSW 20...50 | RKW 20...50



2-, 3-, 4-, and 5-Poles

Mini, 7/8" single-ended cordsets, male 90°, 2-, 3-, 4-, and 5-poles with external threads and molded cable, IEC color code.

RSW

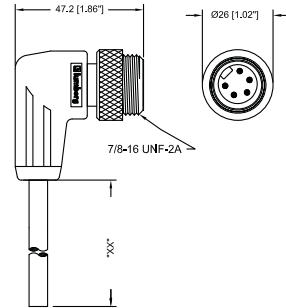

Mini, 7/8" single-ended cordsets, female 90°, 2-, 3-, 4-, and 5-poles with internal threads and molded cable, IEC color code.

RKW

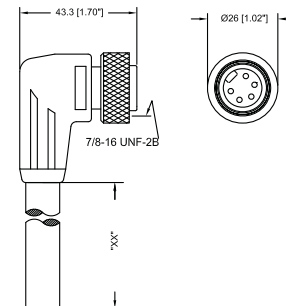

Pin Assignments

Mini, 7/8" - Male / Female

2 poles

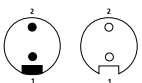

1 = brown
2 = blue

3 poles

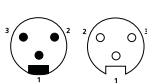

1 = green
2 = brown
3 = blue

4 poles

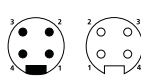

1 = black
2 = blue
3 = brown
4 = white

5 poles

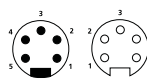

1 = black
2 = blue
3 = yellow w/green tr.
4 = brown
5 = white

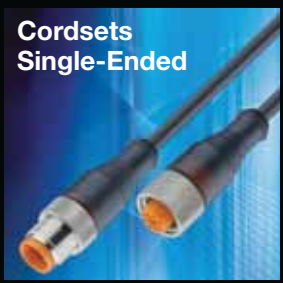

Be Certain with Belden

Mini, 7/8"-Round-Plug Connector, Single-Ended Cordsets, IEC Color Code RSW 20...50 | RKW 20...50

Technical Data

Environmental

Degree of protection IP 67 / NEMA 6P
Operating temperature range -40°C (-40°F) / +90°C (194°F)

Mechanical

Housing / Molded body TPU, yellow
Insert TPU, yellow
Contact CuZn, gold over silver plated
Coupling nut Aluminum, anodized black

Electrical

Current rating 2-3 pole: 8 A
4-5 pole: 5.6 A
Voltage rating 300 V

Cable Specifications - IEC Color Code

Cable No.	Outer Jacket	Gauge	Jacket Color	OD	Temperature Rating	Agency Approvals
603	PVC	18AWG	Yellow	.290" (7.4 mm)	-40°C (-40°F) to +105°C (221°F)	UL: AWM 2661 / CSA: AWM I/II A/B
731	TPE	18AWG	Yellow	.284" (7.2 mm)	-50°C (-58°F) to +90°C (194°F)	UL: PLTC / CSA: AWM I/II A/B
645	PUR	18AWG	Yellow	.220" (5.6 mm)	-40°C (-40°F) to +80°C (176°F)	UL: AWM 20233 / CSA: AWM I/II A/B
637	TPE	18AWG	Yellow	.280" (7.1 mm)	-25°C (-40°F) to +105°C (221°F)	UL: PLTC / CSA: AWM I/II A/B
602	PUR	18AWG	Yellow	.230" (5.8 mm)	-40°C (-40°F) to +80°C (176°F)	UL: AWM 20233 / CSA: AWM I/II A/B
794	TPE	18AWG	Yellow	.304" (7.7 mm)	-50°C (-58°F) to +90°C (194°F)	UL: PLTC / CSA: AWM I/II A/B

Part Number	Pins	Outer Jacket	Standard Cable Lengths	Characteristics
RSW 20-603/...M RKW 20-603/...M	2	PVC	2 M / 5 M / 10 M	
RSW 30-731/...F RKW 30-731/...F	3	TPE	6 F / 12 F / 15 F / 20 F / 30 F	
RSW 30-645/...M RKW 30-645/...M		PUR	2 M / 5 M / 10 M	
RSW 40-637/...F RKW 40-637/...F	4	TPE	6 F / 12 F / 15 F / 20 F / 30 F	
RSW 40-602/...M RKW 40-602/...M		PUR	2 M / 5 M / 10 M	
RSW 50-794/...F RKW 50-794/...F	5	TPE	6 F / 12 F / 15 F / 20 F / 30 F	

Mini, 7/8"-Round-Plug Connector, Single-Ended Cordsets, EURO AC Color Code

RS 30 | RK 30



3-Poles

Mini, 7/8" single-ended cordsets, male straight, 3-poles with external threads and molded cable, EURO AC color code.

RS

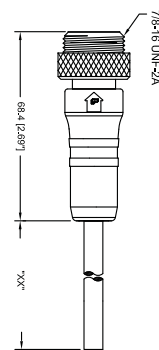
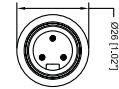

Mini, 7/8" single-ended cordsets, female straight, 3-poles with internal threads and molded cable, EURO AC color code.

RK

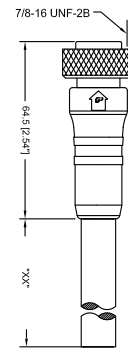
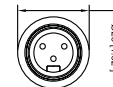

Pin Assignments

Mini, 7/8" - Male / Female

3 poles

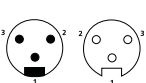

- 1 = yellow/green
- 2 = brown
- 3 = blue

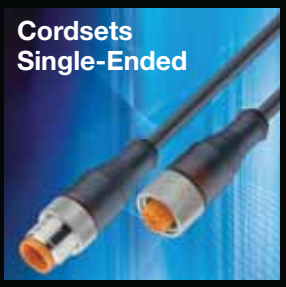

Be Certain with Belden

Mini, 7/8"-Round-Plug Connector, Single-Ended Cordsets, EURO AC Color Code
RS 30 | RK 30

Technical Data

Environmental

Degree of protection IP 67 / NEMA 6P
Operating temperature range -40°C (-40°F) / +90°C (194°F)

Mechanical

Housing / Molded body TPU, yellow
Insert TPU, yellow
Contact CuZn, gold over silver plated
Coupling nut Aluminum, anodized black

Electrical

Current rating 8 A
Voltage rating 300 V

Cable Specifications - EURO AC Color Code

Cable No.	Outer Jacket	Gauge	Jacket Color	OD	Temperature Rating	Agency Approvals
601	PVC	18AWG	Yellow	.290" (7.4 mm)	-40°C (-40°F) to +105°C (221°F)	UL: AWM 2661 / CSA: AWM I/II A/B

Part Number	Pins	Outer Jacket	Standard Cable Lengths	Characteristics
RS 30-601/...M RK 30-60/...M	3	PVC	2 M / 5 M / 10 M	  

Mini, 7/8"-Round-Plug Connector, Single-Ended Cordsets, EURO AC Color Code

RSW 30 | RKW 30

3-Poles

Mini, 7/8" single-ended cordsets, male 90°, 3-poles with external threads and molded cable, EURO AC color code.

RSW

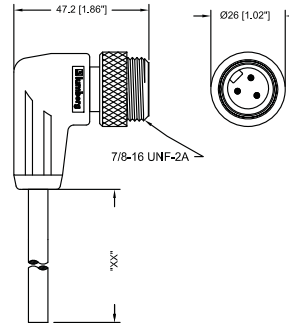

Mini, 7/8" single-ended cordsets, female 90°, 3-poles with internal threads and molded cable, EURO AC color code.

RKW

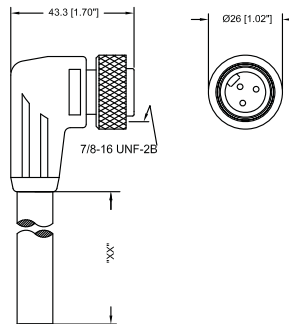

Pin Assignments

Mini, 7/8" - Male / Female

3 poles

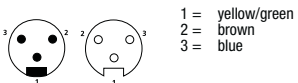



Be Certain with Belden

Mini, 7/8"-Round-Plug Connector, Single-Ended Cordsets, EURO AC Color Code
RSW 30 | RKW 30

Technical Data

Environmental

Degree of protection IP 67 / NEMA 6P
Operating temperature range -40°C (-40°F) / +90°C (194°F)

Mechanical

Housing / Molded body TPU, yellow
Insert TPU, yellow
Contact CuZn, gold over silver plated
Coupling nut Aluminum, anodized black

Electrical

Current rating 8 A
Voltage rating 300 V

Cable Specifications - EURO AC Color Code

Cable No.	Outer Jacket	Gauge	Jacket Color	OD	Temperature Rating	Agency Approvals
601	PVC	18AWG	Yellow	.290" (7.4 mm)	-40°C (-40°F) to +105°C (221°F)	UL: AWM 2661 / CSA: AWM I/II A/B

Part Number	Pins	Outer Jacket	Standard Cable Lengths	Characteristics
RSW 30-601/...M RKW 30-601/...M	3	PVC	2 M / 5 M / 10 M	  

Mini, 1"-Round-Plug Connector, Single-Ended Cordsets, US Color Code

RS 601B...801M | RK 60B...80M



6-, 7-, and 8-Poles

Mini, 1" single-ended cordsets, male straight, 6-, 7-, and 8-poles with internal threads and molded PVC cable, US color code.

RS

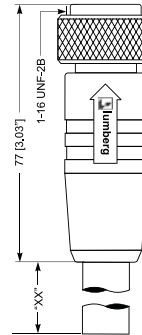

Mini, 1" single-ended cordsets, female straight, 6-, 7-, and 8-poles with internal threads and molded PVC cable, US color code.

RK

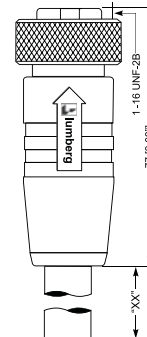

Pin Assignments

Mini, 1" - Male / Female

6 poles

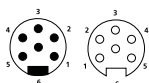

- 1 = orange
- 2 = blue
- 3 = black
- 4 = white
- 5 = red
- 6 = green

7 poles

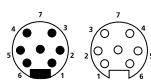

- 1 = white/black
- 2 = black
- 3 = white
- 4 = red
- 5 = orange
- 6 = blue
- 7 = green

8 poles

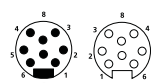

- 1 = orange
- 2 = blue
- 3 = white/black
- 4 = black
- 5 = white
- 6 = red
- 7 = green
- 8 = red/black

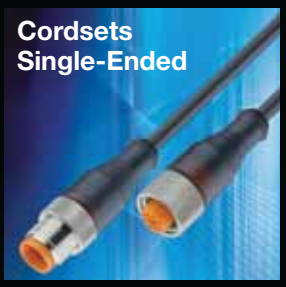

Be Certain with Belden

Mini, 1”-Round-Plug Connector, Single-Ended Cordsets, US Color Code
RS 601B...801M | RK 60B...80M

Technical Data

Environmental

Degree of protection IP 67 / NEMA 6P
Operating temperature range -40°C (-40°F) / +90°C (194°F)

Mechanical

Housing / Molded body TPU, yellow
Insert TPU, yellow
Contact CuZn, gold over silver plated
Coupling nut Aluminum, anodized black

Electrical

Current rating 6 and 7 pole: 8 A
8 pole: 7 A
Voltage rating 600 V

Cable Specifications - US Color Code

Cable No.	Outer Jacket	Gauge	Jacket Color	OD	Temperature Rating	Agency Approvals
696	PVC	16AWG	Yellow	.560" (14.2 mm)	-40°C (-40°F) to +105°C (221°F)	UL: STOW / CSA: STO
622	PVC	16AWG	Yellow	.560" (14.2 mm)	-40°C (-40°F) to +105°C (221°F)	UL: STOW / CSA: STO
698	PVC	16AWG	Yellow	.585" (14.9 mm)	-40°C (-40°F) to +105°C (221°F)	UL: STOW / CSA: STO

Part Number	Pins	Outer Jacket	Standard Cable Lengths	Characteristics
RS 601B-696/...F RK 60B-696/...F	6	PVC	6 F / 12 F / 15 F / 20 F / 30 F	
RS 701M-622/...F RK 70M-622/...F	7	PVC	6 F / 12 F / 15 F / 20 F / 30 F	
RS 801M-698/...F RK 80M-698/...F	8	PVC	6 F / 12 F / 15 F / 20 F / 30 F	

Mini, 1"-Round-Plug Connector, Single-Ended Cordsets, US Color Code

RS 701M...801M | RK 70M...80M



7-, and 8-Poles

Mini, 1" single-ended cordsets, male straight, 7-, and 8-poles with internal threads and molded PUR cable, US color code.

RS

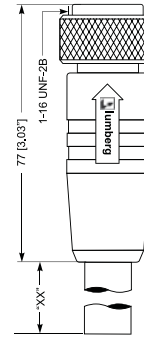

Mini, 1" single-ended cordsets, female straight, 7-, and 8-poles with internal threads and molded PUR cable, US color code.

RK

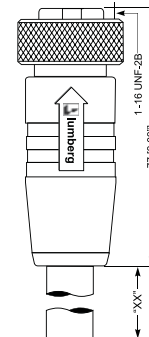

Pin Assignments

Mini, 1" - Male / Female

7 poles

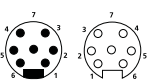

1 = white/black
2 = black
3 = white
4 = red
5 = orange
6 = blue
7 = green

8 poles

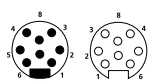

1 = orange
2 = blue
3 = white/black
4 = black
5 = white
6 = red
7 = green
8 = red/black

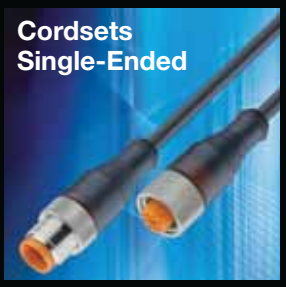

Be Certain with Belden

Mini, 1”-Round-Plug Connector, Single-Ended Cordsets, US Color Code
RS 701M...801M | RK 70M...80M

Technical Data

Environmental

Degree of protection IP 67 / NEMA 6P
Operating temperature range -40°C (-40°F) / +90°C (194°F)

Mechanical

Housing / Molded body TPU, yellow
Insert TPU, yellow
Contact CuZn, gold over silver plated
Coupling nut Aluminum, anodized black

Electrical

Current rating 7 pole: 8 A
8 pole: 7 A
Voltage rating 300 V

Cable Specifications - US Color Code

Cable No.	Outer Jacket	Gauge	Jacket Color	OD	Temperature Rating	Agency Approvals
649	PUR	18AWG	Yellow	.270" (6.9 mm)	-40°C (-40°F) to +80°C (176°F)	UL: AWM 20233 / CSA: AWM I/II A/B
650	PUR	18AWG	Yellow	.292" (7.4 mm)	-40°C (-40°F) to +80°C (176°F)	UL: AWM 20233 / CSA: AWM I/II A/B

Part Number	Pins	Outer Jacket	Standard Cable Lengths	Characteristics
RS 701M-649/...F RK 70M-649/...F	7	PUR	6 F / 12 F / 15 F / 20 F / 30 F	
RS 801M-650/...F RK 80M-650/...F	8	PUR	6 F / 12 F / 15 F / 20 F / 30 F	

Mini, 1 1/8"-Round-Plug Connector, Single-Ended Cordsets, US Color Code

RS 901M...1201M | RK 90M...120M



9-, 10-, and 12-Poles

Mini, 1 1/8" single-ended cordsets, male straight, 9-, 10-, and 12-poles with internal threads and molded PUR cable, US color code.

RS

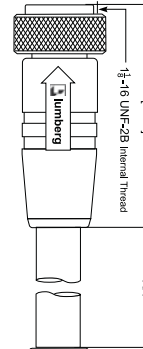

Mini, 1 1/8" single-ended cordsets, female straight, 9-, 10-, and 12-poles with internal threads and molded PUR cable, US color code.

RK

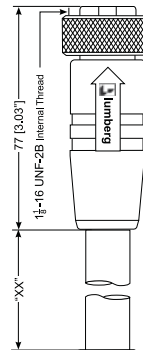

Pin Assignments

Mini, 1 1/8" - Male / Female

9 poles

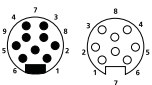

- 1 = orange
- 2 = blue
- 3 = red/black
- 4 = green/black
- 5 = white
- 6 = red
- 7 = green
- 8 = white/black
- 9 = black

10 poles

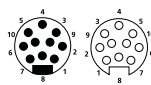

- 1 = orange
- 2 = blue
- 3 = white/black
- 4 = red/black
- 5 = green/black
- 6 = orange/black
- 7 = red
- 8 = green
- 9 = black
- 10 = white

12 poles

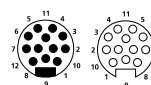

- 1 = orange
- 2 = blue
- 3 = white/black
- 4 = red/black
- 5 = green/black
- 6 = orange/black
- 7 = blue/black
- 8 = black/white
- 9 = green
- 10 = red
- 11 = white
- 12 = black

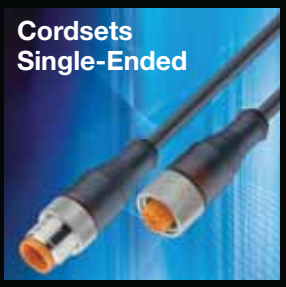

Be Certain with Belden

Mini, 1 1/8"-Round-Plug Connector, Single-Ended Cordsets, US Color Code
RS 901M...1201M | RK 90M...120M

Technical Data

Environmental

Degree of protection IP 67 / NEMA 6P
Operating temperature range -40°C (-40°F) / +90°C (194°F)

Mechanical

Housing / Molded body TPU, yellow
Insert TPU, yellow
Contact CuZn, gold over silver plated
Coupling nut Aluminum, anodized black

Electrical

Current rating 9-10 pole: 7 A
12 pole: 5 A
Voltage rating 300 V

Cable Specifications - US Color Code

Cable No.	Outer Jacket	Gauge	Jacket Color	OD	Temperature Rating	Agency Approvals
651	PUR	18AWG	Yellow	.313" (8.0 mm)	-40°C (-40°F) to +80°C (176°F)	UL: AWM 20233 / CSA: AWM I/II A/B
652	PUR	18AWG	Yellow	.340" (8.6 mm)	-40°C (-40°F) to +80°C (176°F)	UL: AWM 20233 / CSA: AWM I/II A/B
654	PUR	18AWG	Yellow	.354" (9.0 mm)	-40°C (-40°F) to +80°C (176°F)	UL: AWM 20233 / CSA: AWM I/II A/B

Part Number	Pins	Outer Jacket	Standard Cable Lengths	Characteristics
RS 901M-651/...F RK 90M-651/...F	9	PUR	6 F / 12 F / 15 F / 20 F / 30 F	
RS 1001M-652/...F RK 100M-652/...F	10	PUR	6 F / 12 F / 15 F / 20 F / 30 F	
RS 1201M-654/...F RK 120M-654/...F	12	PUR	6 F / 12 F / 15 F / 20 F / 30 F	

Mini, 1 1/8"-Round-Plug Connector, Single-Ended Cordsets, US Color Code

RS 901M...1201M | RK 90M...120M



9-, 10- and 12-Poles

Mini, 1 1/8" single-ended cordsets, male straight, 9-, 10-, 12-poles with internal threads and molded PVC or TPE cable, US color code.

RS

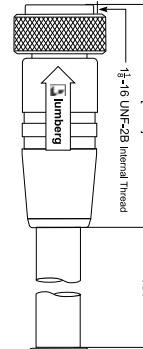

Mini, 1 1/8" single-ended cordsets, female straight, 9-, 10-, 12-poles with internal threads and molded PVC or TPE cable, US color code.

RK

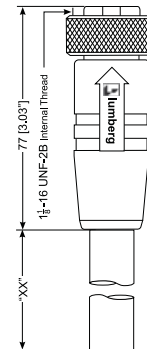

Pin Assignments

Mini, 1 1/8" - Male / Female

9 poles

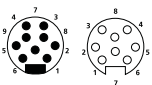

- 1 = orange
- 2 = blue
- 3 = red/black
- 4 = green/black
- 5 = white
- 6 = red
- 7 = green
- 8 = white/black
- 9 = black

10 poles

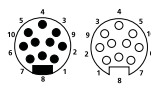

- 1 = orange
- 2 = blue
- 3 = white/black
- 4 = red/black
- 5 = green/black
- 6 = orange/black
- 7 = red
- 8 = green
- 9 = black
- 10 = white

12 poles

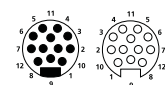

- 1 = orange
- 2 = blue
- 3 = white/black
- 4 = red/black
- 5 = green/black
- 6 = orange/black
- 7 = blue/black
- 8 = black/white
- 9 = green
- 10 = red
- 11 = white
- 12 = black



Be Certain with Belden

Mini, 1 1/8"-Round-Plug Connector, Single-Ended Cordsets, US Color Code
RS 901M...1201M | RK 90M...120M

Technical Data

Environmental

Degree of protection IP 67 / NEMA 6P
Operating temperature range -40°C (-40°F) / +90°C (194°F)

Mechanical

Housing / Molded body TPU, yellow
Insert TPU, yellow
Contact CuZn, gold over silver plated
Coupling nut Aluminum, anodized black

Electrical

Current rating 9-10 pole: 7 A
12 pole: 5 A
Voltage rating 600 V

Cable Specifications - US Color Code

Cable No.	Outer Jacket	Gauge	Jacket Color	OD	Temperature Rating	Agency Approvals
623	PVC	16AWG	Yellow	.660" (16.8 mm)	-40°C (-40°F) to +90°C (194°F)	UL: STOW / CSA: AWM I/II A/B
699	PVC	16AWG	Yellow	.660" (16.8 mm)	-40°C (-40°F) to +90°C (194°F)	UL: STOW / CSA: AWM I/II A/B
724	TPE	16AWG	Yellow	.690" (17.5 mm)	-50°C (-58°F) to +90°C (194°F)	UL: SE00W / CSA: STOW

Part Number	Pins	Outer Jacket	Standard Cable Lengths	Characteristics
RS 901M-623/...F RK 90M-623/...F	9	PVC	6 F / 12 F / 15 F / 20 F / 30 F	
RS 1001M-699/...F RK 100M-699/...F	10	PVC	6 F / 12 F / 15 F / 20 F / 30 F	
RS 1201M-724/...F RK 120M-724/...F	12	TPE	6 F / 12 F / 15 F / 20 F / 30 F	

Mini, 1 1/8"-Round-Plug Connector, Single-Ended Cordsets, IEC Color Code

RS 1201M | RK 120M



12-Poles

Mini, 1 1/8" single-ended cordsets, male straight, 12-poles with external threads, molded TPE cable, IEC color code.

RS

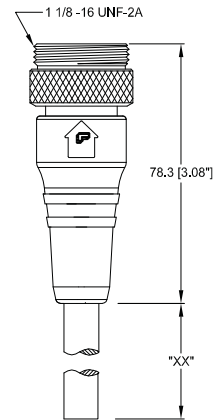

Mini, 1 1/8" single-ended cordsets, female straight, 12 -poles with internal threads, molded TPE cable, IEC color code.

RK

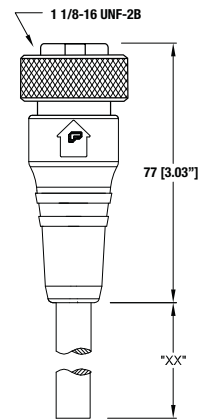

Pin Assignments

Mini, 1 1/8" - Male / Female

12 poles

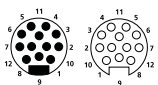

- 1 = black
- 2 = red
- 3 = pink
- 4 = grey
- 5 = yellow
- 6 = green
- 7 = white
- 8 = violet
- 9 = green/yellow
- 10 = blue
- 11 = n.c.
- 12 = brown

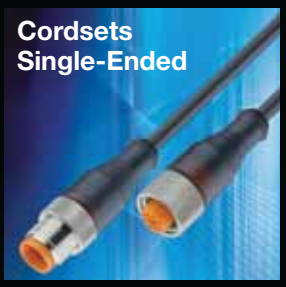

Be Certain with Belden

Mini, 1 1/8"-Round-Plug Connector, Single-Ended Cordsets, IEC Color Code
RS 1201M | RK 120M

Technical Data

Environmental

Degree of protection IP 67 / NEMA 6P
Operating temperature range -40°C (-40°F) / +90°C (194°F)

Mechanical





Housing / Molded body TPU, yellow
Insert TPU, yellow
Contact CuZn, gold over silver plated
Coupling nut Aluminum, anodized black

Electrical

Current rating 5 A
Voltage rating 600 V

Cable Specifications - US Color Code

Cable No.	Outer Jacket	Gauge	Jacket Color	OD	Temperature Rating	Agency Approvals
728	TPE	18AWG	Yellow	.596" (15.1 mm)	-50°C (-58°F) to +90°C (194°F)	UL: SE00W / CSA: ST00W

Part Number	Pins	Outer Jacket	Standard Cable Lengths	Characteristics
RS 1201M-728/...F RK 120M-728/...F	12	TPE	6 F / 12 F / 15 F / 20 F / 30 F	   

Mini, 1 1/8"-Round-Plug Connector, Single-Ended Cordsets, Numeric Color Code

RS 1201M...1901M | RK 120M...190M



12- and 19-Poles

Mini, 1 1/8" single-ended cordsets, male straight, 12- and 19-poles with internal threads and molded PUR cable, Numeric color code.

RS

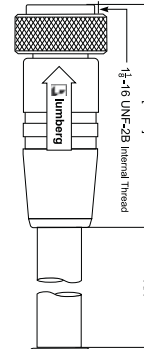

Mini, 1 1/8" single-ended cordsets, female straight, 12- and 19-poles with internal threads and molded PUR cable, Numeric color code.

RK

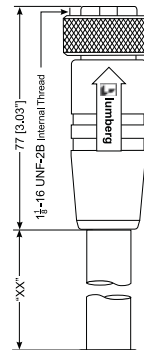

Pin Assignments

Mini, 1 1/8" - Male / Female

12 poles

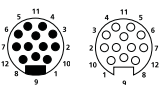

- 1 = black w/ number "1"
- 2 = black w/ number "2"
- 3 = black w/ number "3"
- 4 = black w/ number "4"
- 5 = black w/ number "5"
- 6 = black w/ number "6"
- 7 = black w/ number "7"
- 8 = black w/ number "8"
- 9 = green w/yellow tracer
- 10 = black w/ number "10"
- 11 = black w/ number "11"
- 12 = black w/ number "12"

19 poles

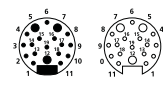

- 1 = black w/ number "1"
- 2 = black w/ number "2"
- 3 = black w/ number "3"
- 4 = black w/ number "4"
- 5 = black w/ number "5"
- 6 = black w/ number "6"
- 7 = black w/ number "7"
- 8 = black w/ number "8"
- 9 = black w/ number "9"
- 10 = black w/ number "10"
- 11 = black w/ number "11"
- 12 = green w/yellow tracer
- 13 = black w/ number "13"
- 14 = black w/ number "14"
- 15 = black w/ number "15"
- 16 = black w/ number "16"
- 17 = black w/ number "17"
- 18 = black w/ number "18"
- 19 = black w/ number "19"

19 poles - current rating

- 1-4, 6, 8-11, and 13-19 = 3 A
- 5 and 7 = 8 A
- 12 = Ground

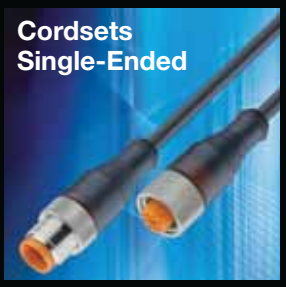

Be Certain with Belden

Mini, 1 1/8"-Round-Plug Connector, Single-Ended Cordsets, Numeric Color Code
RS 1201M..1901M | RK 120M...190M

Technical Data

Environmental

Degree of protection IP 67 / NEMA 6P
Operating temperature range -40°C (-40°F) / +90°C (194°F)

Mechanical







Housing / Molded body TPU, yellow
Insert TPU, yellow
Contact CuZn, gold over silver plated
Coupling nut Aluminum, anodized black

Electrical

Current rating 12 poles: 5 A
19 poles: see pin assignments
Voltage rating 300 V

Cable Specifications - Numeric Color Code

Cable No.	Outer Jacket	Gauge	Jacket Color	OD	Temperature Rating	Agency Approvals
676	PUR	18AWG	Yellow	.390" (9.9 mm)	-40°C (-40°F) to +80°C (176°F)	UL: AWM 20233 / CSA: AWM I/II A/B
669	PUR	18AWG	Yellow	.489" (12.4 mm)	-40°C (-40°F) to +80°C (176°F)	UL: AWM 20233 / CSA: AWM I/II A/B

Part Number	Pins	Outer Jacket	Standard Cable Lengths	Characteristics
RS 1201M-676/...M RK 120M-676/...M	12	PUR	2 M / 5 M / 10 M / 15 M	  
RS 1901M-669/...M RK 190M-669/...M	19	PUR	2 M / 5 M / 10 M / 15 M	  

M23-Round-Plug Connector, Single-Ended Cordsets

RSUF | RKU | RKUE



12- and 19-Poles

M23 cordsets, single ended, male straight connector, 12- and 19-poles with threaded joint, external threads and molded cable.

RSUF

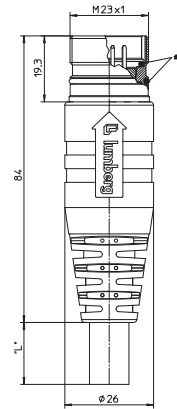

M23 cordsets, single ended, female straight connector, 12- and 19-poles with threaded joint, internal threads and molded cable.

RKU/RKUE

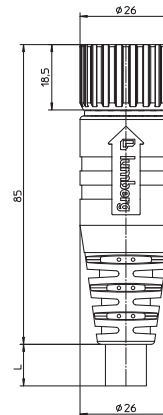

Pin Assignments

M23 - Male / Female

12 poles

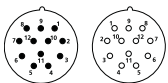

- 1 = white
- 2 = green
- 3 = yellow
- 4 = grey
- 5 = grey/pink
- 6 = red/blue
- 7 = white/green
- 8 = brown/green
- 9 = blue
- 10 = blue
- 11 = brown
- 12 = yellow/green

19 poles

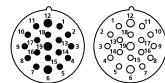

- 1 = violet
- 2 = red
- 3 = grey
- 4 = red/blue
- 5 = green
- 6 = blue
- 7 = grey/pink
- 8 = white/green
- 9 = white/yellow
- 10 = white/grey
- 11 = black
- 12 = yellow/green
- 13 = yellow/brown
- 14 = brown/green
- 15 = white
- 16 = yellow
- 17 = pink
- 18 = grey/brown
- 19 = brown

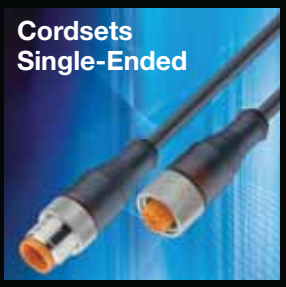

Be Certain with Belden

M23-Round-Plug Connector, Single-Ended Cordsets

RSUF | RKU | RKUE

Technical Data

Environmental

Degree of protection IP 67 / NEMA 6P
Operating temperature range -25°C (-13°F) / +80°C (+176°F)

Mechanical

Housing / Molded body TPU, self-extinguishing
Insert PBT
Contact CuZn, pre-nickel and 0.8 microns gold-plated
Coupling nut CuZn, nickel-plated

Electrical

Contact resistance ≤ 5 mΩ
Nominal current at 40°C 12 poles 8 A
19 poles 8 A pin Ø 1 mm,
10 A pin Ø 1.5 mm
Nominal voltage 12 poles 240 V
19 poles 120 V
Rated voltage 12 poles 250 V
19 poles 125 V
Test voltage 12 poles 2.5 kV eff./ 60 s
19 poles 1.5 kV eff./ 60 s
Insulation resistance > 10⁹ Ω
Pollution degree 3

Cable Specifications

Cable No.	Outer Jacket	Gauge	Jacket Color	OD	Agency Approvals
256	PUR, halogen-free	18AWG	Black	8 x 0.50mm ² 3 x 1.00mm ²	UL: AWM 21198 / CSA: AWM I/II A/B
242	PUR, halogen-free	18AWG	Black	3 x 1.00mm ² 16 x 0.50mm ²	UL: AWM 21198 / CSA: AWM I/II A/B

Part Number	Pins	Outer Jacket	Standard Cable Lengths	Characteristics
RSUF 12-256/...M RKU 12-256/...M	12	PUR, halogen-free	5 M / 10 M / 15 M / 20 M	
RSUF 19-242/...M RKUE 19-242/...M	19	PUR, halogen-free	5 M / 10 M / 15 M / 20 M	
		PUR, halogen-free	5 M / 10 M / 15 M / 20 M	

M23-Round-Plug Connector, Single-Ended Cordsets

RSWUF | RKWU | RKWUE



12- and 19-Poles

M23 cordsets, single ended, male 90° connector, 12- and 19-poles with threaded joint, external threads and molded cable.



M23 cordsets, single ended, female 90° connector, 12- and 19-poles with threaded joint, internal (female) threads and molded cable.

RSWUF

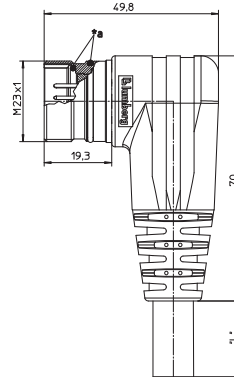

RKWU/RKWUE

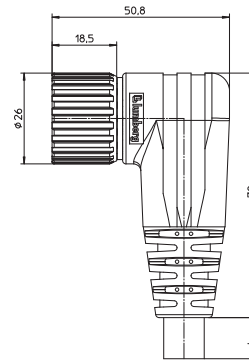

Pin Assignments

M23 - Male / Female

12 poles

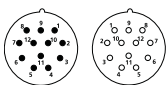

- 1 = white
- 2 = green
- 3 = yellow
- 4 = grey
- 5 = grey/pink
- 6 = red/blue
- 7 = white/green
- 8 = brown/green
- 9 = blue
- 10 = blue
- 11 = brown
- 12 = yellow/green

19 poles

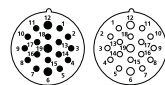

- 1 = violet
- 2 = red
- 3 = grey
- 4 = red/blue
- 5 = green
- 6 = blue
- 7 = grey/pink
- 8 = white/green
- 9 = white/yellow
- 10 = white/grey
- 11 = black
- 12 = yellow/green
- 13 = yellow/brown
- 14 = brown/green
- 15 = white
- 16 = yellow
- 17 = pink
- 18 = grey/brown
- 19 = brown



Be Certain with Belden

M23-Round-Plug Connector, Single-Ended Cordsets

RSWUF | RKWU | RKWUE

Technical Data

Environmental

Degree of protection IP 67 / NEMA 6P
 Operating temperature range -25°C (-13°F) / +80°C (+176°F)

Mechanical

Housing / Molded body TPU, self-extinguishing
 Insert PBT
 Contact CuZn, pre-nickel and 0.8 microns gold-plated
 Coupling nut CuZn, nickel-plated

Electrical

Contact resistance ≤ 5 mΩ
 Nominal current at 40°C 12 poles 8 A
 19 poles 8 A pin Ø 1 mm,
 10 A pin Ø 1.5 mm
 Nominal voltage 12 poles 240 V
 19 poles 120 V
 Rated voltage 12 poles 250 V
 19 poles 125 V
 Test voltage 12 poles 2.5 kV eff./ 60 s
 19 poles 1.5 kV eff./ 60 s
 Insulation resistance > 10⁹ Ω
 Pollution degree 3

Cable Specifications

Cable No.	Outer Jacket	Jacket Color	OD	Agency Approvals
256	PUR, halogen-free	Black	8 x 0.50mm ² 3 x 1.00mm ²	UL: AWM 21198 / CSA: AWM I/II A/B
242	PUR, halogen-free	Black	3 x 1.00mm ² 16 x 0.50mm ²	UL: AWM 21198 / CSA: AWM I/II A/B

Part Number	Pins	Outer Jacket	Standard Cable Lengths	Characteristics	
Male 90°	Female 90°				
RSWUF 12-256/...M	RKWU 12-256/...M	12	PUR, halogen-free	5 M / 10 M / 15 M / 20 M	
RSWUF 19-242/...M	RKWU 19-242/...M	19	PUR, halogen-free	5 M / 10 M / 15 M / 20 M	
	RKWUE 19-242/...M		PUR, halogen-free	5 M / 10 M / 15 M / 20 M	

M8-Double-Ended Cordsets for Actuators, Sensors and Distribution Boxes

RSMV-RKM | RSMV-RKMV



3-Poles

Actuator/sensor cordset, double-ended, M8, 3-pole, male straight with threaded joint to female straight connector with snap-in joint and molded cable.

RSMV-RKM

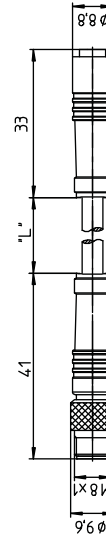

Actuator/sensor cordset, double-ended, M8, 3-pole, male straight with threaded joint to female straight connector and molded cable.

RSMV-RKMV

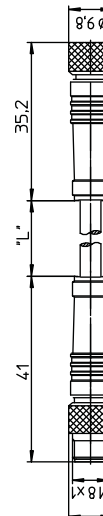

Pin Assignments

M8 - Male / Female

3 poles

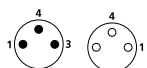

- 1 = brown
- 3 = blue
- 4 = black

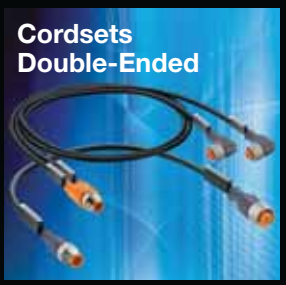

Be Certain with Belden

M8-Double-Ended Cordsets for Actuators, Sensors and Distribution Boxes
RSMV-RKM | RSMV-RKMV

Technical Data

Environmental

Degree of protection IP 65 / IP 67 / NEMA 6P
Operating temperature range -40°C (-40°F) / +90°C (+194°F)

Mechanical

Housing / Molded body TPU, self-extinguishing
Insert PA / TPU
Contact CuZn, pre-nickel and 0.8 microns gold-plated
Coupling nut CuZn, nickel-plated (only RSMV / RKMV)

Electrical

Nominal current at 40°C 4 A
Nominal voltage 60 V
Rated voltage 63 V
Test voltage 1.5 kV eff. / 60 s
Insulation resistance > 10⁹ Ω
Pollution degree 3

Cable Specifications

Cable No.	Outer Jacket	Gauge	Jacket Color	OD	Agency Approvals
224	PUR, halogen-free	3 x 0.34 mm ²	Black	.169" (4.3 mm)	UL: AWM 21198 / CSA: AWM I/II A/B

Part Number	Pins	Standard Cable Lengths	Characteristics
RSMV 3-RKM 3-224/...M	3	0.6 M / 1 M / 2 M	
RSMV 3-RKMV 3-224/...M		0.6 M / 1 M / 2 M	

M8-Double-Ended Cordsets for Actuators, Sensors and Distribution Boxes

RSMV-RKMVV | RSMV-RKMVV/LED



3-Poles

Actuator/sensor cordset, double-ended, M8, 3-pole male straight with threaded joint to female 90° connector and molded cable.

RSMV-RKMVV

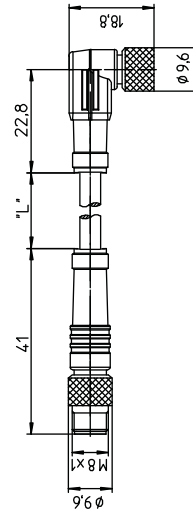

Actuator/sensor cordset, double-ended, M8, 3-pole, male straight with threaded joint to female 90° connector with LED operation and function indicator and molded cable.

RSMV-RKMVV/LED

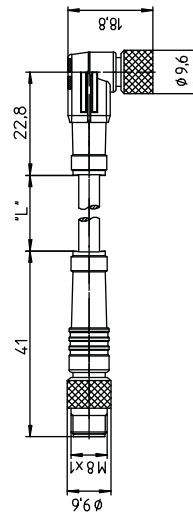

Pin Assignments

M8 - Male / Female

3 poles

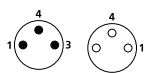

- 1 = brown
- 3 = blue
- 4 = black

Wiring Diagram / LED

pnp Normally open = yellow-green

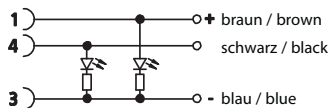

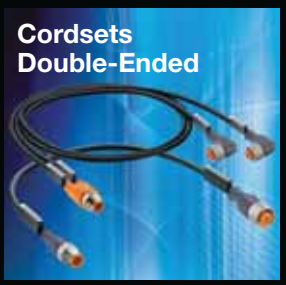

Be Certain with Belden

M8-Double-Ended Cordsets for Actuators, Sensors and Distribution Boxes
RSMV-RKMWW | RSMV-RKMWW/LED

Technical Data

Environmental

Degree of protection IP 65 / IP 67 / NEMA 6P
Operating temperature range -40°C (-40°F) / +90°C (+194°F)

Mechanical





Housing / Molded body TPU, self-extinguishing
Insert PA / TPU
Contact CuZn, pre-nickel and 0.8 microns gold-plated
Coupling nut CuZn, nickel-plated (only RSMV / RKMV)

Electrical

Nominal current at 40°C 4 A
Nominal voltage RSMV / RKMWW: 60 V
RKMWW/LED: 10-30 V DC
Rated voltage RSMV / RKMWW: 63 V
RKMWW/LED: 32 V
Test voltage 1.5 kV eff. / 60 s
Insulation resistance > 10⁹ Ω
Pollution degree 3

Cable Specifications

Cable No.	Outer Jacket	Gauge	Jacket Color	OD	Agency Approvals
224	PUR, halogen-free	3 x 0.34 mm ²	Black	.169" (4.3 mm)	UL: AWM 21198 / CSA: AWM I/II A/B

Part Number	Pins	Standard Cable Lengths	Characteristics
RSMV 3-RKMWW 3-224/...M	3	0.6 M / 1 M / 2 M	   

M8 / M12-Double-Ended Cordsets for Actuators, Sensors and Distribution Boxes

RSMV-RKT | RSMV-RKWT



3-Poles

Actuator/sensor cordset, double-ended, M8, 3-pole, male straight to M12 female straight connector with molded cable.

RSMV-RKT

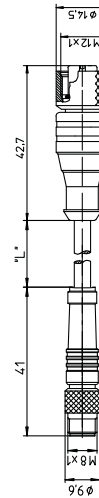

Actuator/sensor cordset, double-ended, M8, 3-pole male straight to M12 female 90° connector with molded cable.

RSMV-RKWT

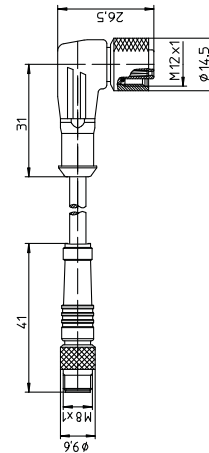

Pin Assignments

M8 / M12 - Male / Female

3 poles

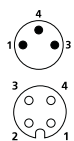

- 1 = brown
- 2 = n.c.
- 3 = blue
- 4 = black

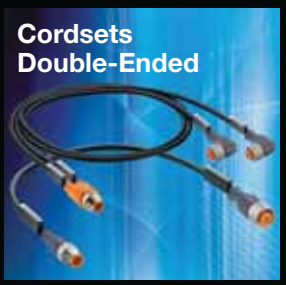

Be Certain with Belden

M8 / M12-Double-Ended Cordsets for Actuators, Sensors and Distribution Boxes
RSMV-RKT | RSMV-RKWT

Technical Data

Environmental

Degree of protection IP 67 / NEMA 6P
Operating temperature range -25°C (-13°F) / +80°C (+176°F)

Mechanical

Housing / Molded body TPU, self-extinguishing
Insert RSMV: PA / TPU
RKT / RKWT: TPU
Contact RSMV: CuZn, pre-nickel and 0.8 microns gold-plated
RKT / RKWT: CuZn, pre-nickel and 0.3 microns gold-plated
Coupling nut CuZn, nickel-plated
O-ring FKM (only RKT / RKWT)

Electrical

Nominal current at 40°C 4 A
Nominal voltage 60 V
Rated voltage 63 V
Test voltage 1.5 kV eff. / 60 s
Insulation resistance > 10⁹ Ω
Pollution degree 3

Cable Specifications

Cable No.	Outer Jacket	Gauge	Jacket Color	OD	Agency Approvals
224	PUR, halogen-free	3 x 0.34 mm ²	Black	.169" (4.3 mm)	UL: AWM 21198 / CSA: AWM I/II A/B

Part Number	Pins	Standard Cable Lengths	Characteristics
RSMV 3-RKT 4-3-224/...M RSMV 3-RKWT 4-3-224/...M	3	0.6 M / 1 M / 2 M	

M8 / M12-Double-Ended Cordsets for Actuators, Sensors and Distribution Boxes

RSMV-RKWT/LED



3-Poles

Actuator/sensor cordset, double-ended, M8, 3-pole, male straight to M12, 3-pole female 90° connector with LED operation and function indicator and molded cable.

RSMV-RKWT/LED

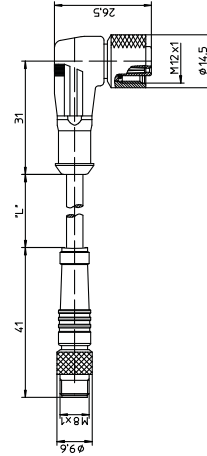

Pin Assignments

M8 / M12 - Male / Female

3 poles

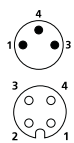

- 1 = brown
- 2 = n.c.
- 3 = blue
- 4 = black

Wiring Diagram / LED

pnp Normally open = yellow-green

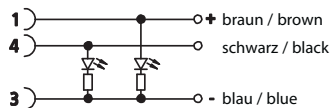

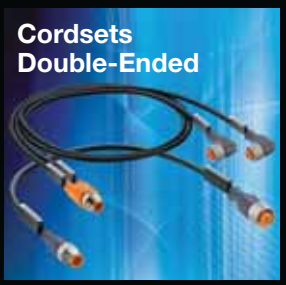

Be Certain with Belden

M8 / M12-Double-Ended Cordsets for Actuators, Sensors and Distribution Boxes
RSMV-RKWT/LED

Technical Data

Environmental

Degree of protection IP 67 / NEMA 6P
Operating temperature range -25°C (-13°F) / +80°C (+176°F)

Mechanical

Housing / Molded body TPU
Insert RSMV: PA / TPU
RKWT/LED: TPU
Contact RSMV: CuZn, pre-nickeled and 0.8 microns gold-plated
RKT / RKWT: CuZn, pre-nickeled and 0.3 microns gold-plated
Coupling nut CuZn, nickel-plated
O-ring FKM (only RKWT/LED)

Electrical

Nominal current at 40°C 4 A
Nominal voltage 10-30 V DC
Rated voltage 32 V
Insulation resistance > 10⁹ Ω
Pollution degree 3

Cable Specifications

Cable No.	Outer Jacket	Gauge	Jacket Color	OD	Agency Approvals
224	PUR, halogen-free	3 x 0.34 mm ²	Black	.169" (4.3 mm)	UL: AWM 21198 / CSA: AWM I/II A/B

Part Number	Pins	Standard Cable Lengths	Characteristics
RSMV 3-RKWT/LED A 4-3-224/...M	3	0.6 M / 1 M / 2 M	

Cordsets Double-Ended

M12 / M8-Double-Ended Cordsets for Actuators, Sensors and Distribution Boxes

RST-RKM | RST-RKMV



3-Poles

Actuator/sensor cordset, double-ended, M12, 3-pole, male straight to M8, 3-pole female straight, snap-in connector and molded cable.

RST-RKM

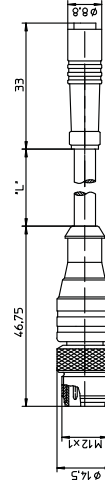

Actuator/sensor cordset, double-ended, M12, 3-pole, male straight to M8, 3-pole female straight connector with threaded joint and molded cable.

RST-RKMV

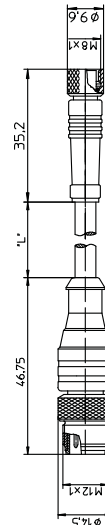

Pin Assignments

M12 / M8 - Male / Female

3 poles



- 1 = brown
- 3 = blue
- 4 = black



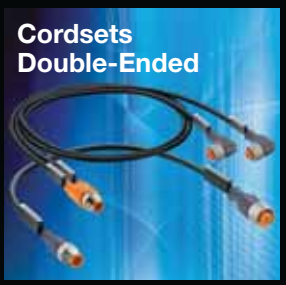

Be Certain with Belden

M12 / M8-Double-Ended Cordsets for Actuators, Sensors and Distribution Boxes
RST-RKM | RST-RKMW

Technical Data

Environmental

Degree of protection IP 67 / NEMA 6P
Operating temperature range -25°C (-13°F) / +80°C (+176°F)

Mechanical

Housing / Molded body TPU
Insert RST: TPU
RKM / RKMV: PA / TPU
Contact CuZn, pre-nickel and 0.8 microns gold-plated
Coupling nut CuZn, nickel-plated
O-ring FKM (only RKMV)

Electrical

Nominal current at 40°C 4 A
Nominal voltage 60 V
Rated voltage 63 V
Test voltage 1.5 kV eff. / 60 s
Insulation resistance > 10⁹ Ω
Pollution degree 3

Cable Specifications

Cable No.	Outer Jacket	Gauge	Jacket Color	OD	Agency Approvals
224	PUR, halogen-free	3 x 0.34 mm ²	Black	.169" (4.3 mm)	UL: AWM 21198 / CSA: AWM I/II A/B

Part Number	Pins	Standard Cable Lengths	Characteristics
RST 3-RKM 3-224/...M	3	0.3 M / 0.6 M / 1 M / 1.5 M / 2 M / 5 M	
RST 3-RKMV 3-224/...M		0.3 M / 0.6 M / 1 M / 1.5 M / 2 M / 5 M	

M12 / M8-Double-Ended Cordsets for Actuators, Sensors and Distribution Boxes

RST-RKMW/LED | RST-RKMWW/LED



3-Poles

Actuator/sensor cordset, double-ended, M12, 3-pole, male straight to M8, 3-pole female 90° snap-in connector with LED operation and function indicator and molded cable.

RST-RKMW/LED

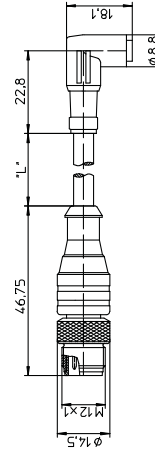

Actuator/sensor cordset, double-ended, M12, 3-pole, male straight to M8, 3-pole female 90° connector, threaded joints with LED operation and function indicator and molded cable.

RST-RKMWW/LED

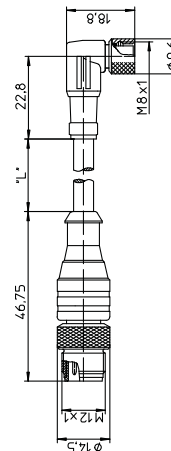

Pin Assignments

M8 / M12 - Male / Female

3 poles

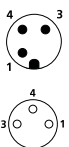

- 1 = brown
- 2 = n.c.
- 3 = blue
- 4 = black

Wiring Diagram / LED

pnp Normally open = yellow-green

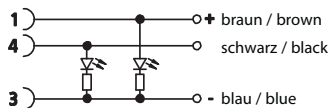

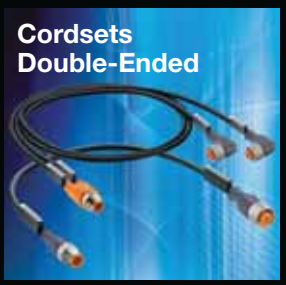

Be Certain with Belden

M12 / M8-Double-Ended Cordsets for Actuators, Sensors and Distribution Boxes
RST-RKMV/LED | RST-RKMWV/LED

Technical Data

Environmental

Degree of protection IP 67 / IP 65 / NEMA 6P
Operating temperature range -25°C (-13°F) / +80°C (+176°F)

Mechanical







Housing / Molded body TPU
Insert RST: TPU
RKM(W)V/LED: PA / TPU
Contact 0.8 microns gold-plated
Coupling nut CuZn, nickel-plated (only RST / RKMWV/LED)
O-ring FKM (only RKMWV/LED)

Electrical

Nominal current at 40°C 4 A
Nominal voltage 10-30 V DC
Rated voltage 32 V
Insulation resistance > 10⁹ Ω
Pollution degree 3

Cable Specifications

Cable No.	Outer Jacket	Gauge	Jacket Color	OD	Agency Approvals
224	PUR, halogen-free	3 x 0.34 mm ²	Black	.169" (4.3 mm)	UL: AWM 21198 / CSA: AWM I/II A/B

Part Number	Pins	Standard Cable Lengths	Characteristics
RST 3-RKMW/LED A 3-224/...M	3	0.3 M / 0.6 M / 1 M / 1.5 M / 2 M / 5 M	  
RST 3-RKMWV/LED A 3-224/...M		0.3 M / 0.6 M / 1 M / 1.5 M / 2 M / 5 M	   

M12-Round-Plug Connector, Double-Ended Cordsets, According to IEC 61076-2-101

RST -RKT | RST-RKWT



3-, 4-, 5-, and 8-Poles

Actuator/sensor cordset, double-ended, M12, 3-, 4-, 5-, and 8-poles, male straight to female straight connector with self-locking thread and molded cable, IEC color code.

RST-RKT

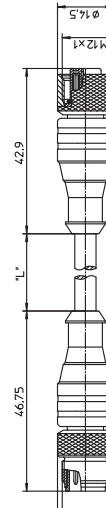

Actuator/sensor cordset, double-ended, M12, 3-, 4-, 5-, and 8-poles, male straight to female 90° connector with self-locking thread and molded cable, IEC color code.

RST-RKWT

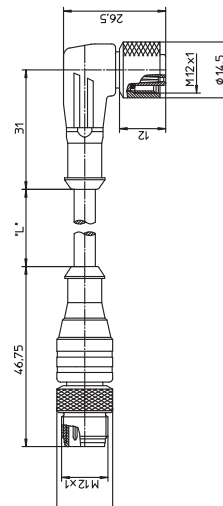

Pin Assignments

M12 - Male

3 poles

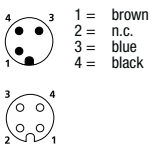

4 poles

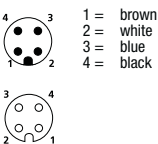

5 poles

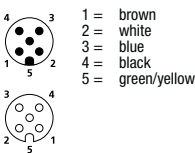

6 poles

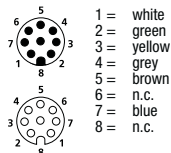

8 poles

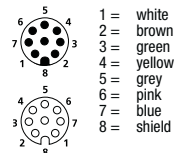



Be Certain with Belden

M12-Round-Plug Connector, Double-Ended Cordsets, According to IEC 61076-2-101

RST-RKT | RST-RKWT

Technical Data

Environmental

Degree of protection IP 67 / NEMA 6P
Operating temperature range -25°C (-13°F) / +80°C (+176°F)

Mechanical

Housing / Molded body TPU
Insert TPU
Contact RST: CuSn, pre-nickeled and 0.8 microns gold-plated
RKT / RKWT: CuSn, pre-nickeled and 0.3 microns gold-plated
Coupling nut CuZn, nickel-plated
O-ring FKM (only RKT / RKWT)

Electrical

Contact resistance ≤ 5 mΩ
Nominal current at 40°C 3–5 poles 4 A
6–8 poles 2 A
Nominal voltage 3–4 poles 240 V
5 poles 60 V, 6–8 poles 30 V
Rated voltage 3–4 poles 250 V
5 poles 63 V, 6–8 poles 36 V
Test voltage 3–4 poles 2.0 kV eff. / 60 s
5–8 poles 1.5 kV eff. / 60 s
Insulation resistance > 10⁹ Ω
Pollution degree 3

Cable Specifications

Cable No.	Outer Jacket	Conductor Size	Jacket Color	OD
224	PUR, halogen-free	3 x 0.34 mm ²	Black	.169" (4.3 mm)
225	PUR, halogen-free	4 x 0.34 mm ²	Black	.185" (4.7 mm)
228	PUR, halogen-free	5 x 0.50 mm ²	Black	.213" (5.4 mm)
251	PUR, halogen-free welding spark proof	4 x 0.34 mm ²	Orange	.185" (4.7 mm)
259	PUR, halogen-free welding spark proof	5 x 0.50 mm ²	Orange	.217" (5.5 mm)
268	PUR, halogen-free welding spark proof	6 x 0.34 mm ²	Orange	.236" (6.0 mm)
282	PUR, halogen-free	7 x 0.25 mm ²	Black	.236" (6.0 mm)
337	PUR, halogen-free	6 x 0.34 mm ²	Black	.236" (6.0 mm)

Cordsets
Double-Ended

Part Number	Pins	Outer Jacket	Standard Cable Lengths	Characteristics
RST 3-RKT 4-3-224/...M RST 3-RKWT 4-3-224/...M	3	PUR, halogen-free	0.3 M / 0.6 M / 1 M / 1.5 M / 2 M / 5 M	
RST 4-RKT 4-225/...M RST 4-RKWT 4-225/...M	4	PUR, halogen-free	0.3 M / 0.6 M / 1 M / 1.5 M / 2 M / 5 M	
RST 4-RKT 4-251/...M		PUR, halogen-free, weld spark proof	0.3 M / 0.6 M / 1 M / 1.5 M / 2 M / 5 M	
RST 5-RKT 5-228/...M	5	PUR, halogen-free	0.3 M / 0.6 M / 1 M / 1.5 M / 2 M / 5 M	
RST 5-RKT 5-259/...M		PUR, halogen-free, weld spark proof	0.3 M / 0.6 M / 1 M / 1.5 M / 2 M / 5 M	
RST 8-RKT 8-6-268/...M RST 8-RKWT 8-6-268/...M	6	PUR, halogen-free, weld spark proof	2 M / 5 M / 10 M	
RST 8-RKT 8-6-337/...M RST 8-RKWT 8-6-337/...M		PUR, halogen-free	2 M / 5 M / 10 M	
RST 8-RKT 8-282/...M RST 8-RKWT 8-282/...M	8	PUR, halogen-free	0.3 M / 0.6 M / 1 M / 1.5 M / 2 M / 5 M	

M12-Round-Plug Connector, Double-Ended Cordsets, According to IEC 61076-2-101

RST -RKT | RST-RKWT



8-Poles

Actuator/sensor cordset, double-ended, M12, 8-poles, male straight to female straight connector with self-locking thread and molded PVC black cable, IEC color code.

RST-RKT

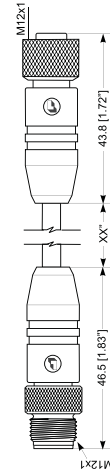

Actuator/sensor cordset, double-ended, M12, 8-poles, male straight to female 90° connector with self-locking thread and molded PVC black cable, IEC color code.

RST-RKWT

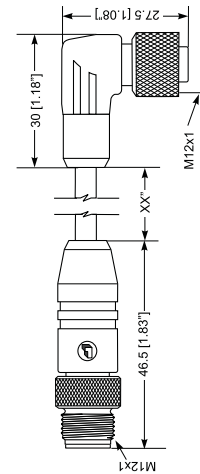

Pin Assignments

M12 - Male

8 poles

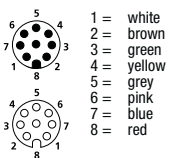

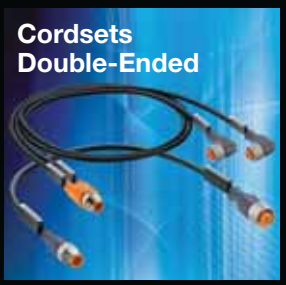

Be Certain with Belden

M12-Round-Plug Connector, Double-Ended Cordsets, According to IEC 61076-2-101
 RST-RKT | RST-RKWT

Technical Data

Environmental

Degree of protection IP 67 / NEMA 6P
 Operating temperature range -40°C (-40°F) / +90°C (194°F)

Mechanical

Housing / Molded body TPU, black
 Insert TPU, black (female)
 TPU, orange (male)
 Contact CuSn, gold over nickel plated
 Coupling nut CuZn, nickel-plated

Electrical

Current rating 4 A
 Voltage rating 60 V AC / 75 V DC

Cable Specifications

Cable No.	Outer Jacket	Conductor Size	Jacket Color	OD
627	PVC	24AWG	Black	.232" (5.9 mm)

Part Number	Pins	Outer Jacket	Standard Cable Lengths	Characteristics
RST 8-RKT 8-627/...M	8	PVC	0.3 M / 0.6 M / 1 M / 2 M / 5 M	

Cordsets Double-Ended

M12-Round-Plug Connector, Double-Ended Cordsets, According to IEC 61076-2-101

RST -RKT | RST-RKWT



3-, 4-, and 5-Poles

Actuator/sensor cordset, double-ended, M12, 3-, 4-, and 5-poles, male straight to female straight connector with self-locking thread and molded TPE, PUR, or PVC cable, IEC color code.

RST-RKT

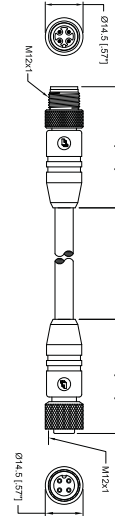

Actuator/sensor cordset, double-ended, M12, 3-, 4-, and 5-poles, male straight to female 90° connector with self-locking thread and molded TPE, PUR, or PVC cable, IEC color code.

RST-RKWT

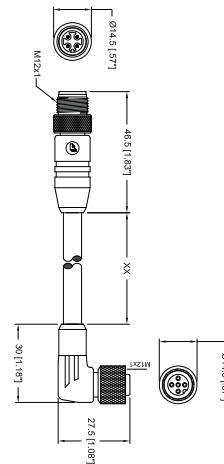

Pin Assignments

M12 - Male

3 poles

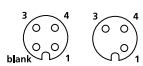

1 = brown
3 = blue
4 = black

4 poles



1 = brown
2 = white
3 = blue
4 = black

5 poles



1 = brown
2 = white
3 = blue
4 = black
5 = grey



Be Certain with Belden

M12-Round-Plug Connector, Double-Ended Cordsets, According to IEC 61076-2-101

RST-RKT | RST-RKWT

Technical Data

Environmental

Degree of protection IP 67 / NEMA 6P
 Operating temperature range PUR: -40°C (-40°F) / +80°C (176°F)
 PVC: -40°C (-40°F) / +90°C (194°F)
 TPE: -40°C (-40°F) / +90°C (194°F)

Mechanical

Housing / Molded body TPU, yellow
 Insert TPU, yellow
 Contact CuSn, gold plated
 Coupling nut CuZn, nickel-plated
 O-ring Viton

Electrical

Current rating 4 A
 Voltage rating 250 V

Cable Specifications

Cable No.	Outer Jacket	Conductor Size	Jacket Color	OD
602	PUR	18AWG	Yellow	.230" (5.8 mm)
610	PUR	22AWG	Yellow	.190" (4.8 mm)
612	PVC	22AWG	Yellow	.210" (5.3 mm)
632	PVC	22AWG	Yellow	.190" (4.8 mm)
633	PVC	22AWG	Yellow	.190" (4.8 mm)
637	TPE	18AWG	Yellow	.280" (7.1 mm)
643	TPE	22AWG	Yellow	.246" (6.2 mm)
644	PUR	22AWG	Yellow	.210" (5.3 mm)
645	PUR	18AWG	Yellow	.220" (5.6 mm)
679	PUR	22AWG	Yellow	.190" (4.8 mm)
731	TPE	18AWG	Yellow	.261" (6.6 mm)

Cordsets
Double-Ended

Part Number	Pins	Outer Jacket	Standard Cable Lengths	Characteristics
RST 3-RKT 4-3-731/...M RST 3-RKWT 4-3-731/...M	3	TPE	2 M / 5 M / 10 M	
RST 3-RKT 4-3-632/...M RST 3-RKWT 4-3-632/...M		PVC	2 M / 5 M / 10 M	
RST 3-RKT 4-3-645/...M RST 3-RKWT 4-3-645/...M		PUR	2 M / 5 M / 10 M	
RST 3-RKT 4-3-610/...M RST 3-RKWT 4-3-610/...M		PUR	2 M / 5 M / 10 M	
RST 4-RKT 4-637/...M RST 4-RKWT 4-637/...M	4	TPE	2 M / 5 M / 10 M	
RST 4-RKT 4-633/...M RST 4-RKWT 4-633/...M		PVC	2 M / 5 M / 10 M	
RST 4-RKT 4-643/...M RST 4-RKWT 4-643/...M		TPE	2 M / 5 M / 10 M	
RST 4-RKT 4-602/...M RST 4-RKWT 4-602/...M		PUR	2 M / 5 M / 10 M	
RST 4-RKT 4-679/...M RST 4-RKWT 4-679/...M		PUR	2 M / 5 M / 10 M	
RST 5-RKT 5-612/...M RST 5-RKWT 5-612/...M	5	PVC	2 M / 5 M / 10 M	
RST 5-RKT 5-644/...M RST 5-RKWT 5-644/...M		PUR	2 M / 5 M / 10 M	

M12-Round-Plug Connector, Double-Ended Cordsets, According to IEC 61076-2-101

RST-RKWT/LED



3- and 4-Poles

Actuator/sensor cordset, double-ended, M12, 3- and 4-poles, male straight to female 90° connector with LED operation and function indicator, self-locking thread and molded cable.

RST-RKWT/LED

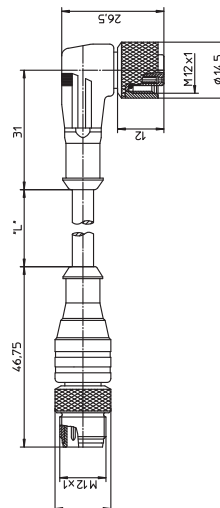

Pin Assignments

M12 - Male

3 poles

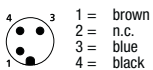

4 poles

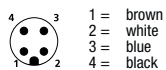

Wiring Diagrams / LED

A pnp Normally open yellow-green

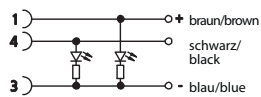

P pnp Normally closed/open yellow-green

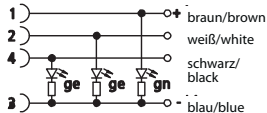

R pnp Normally closed/open yellow-red-green

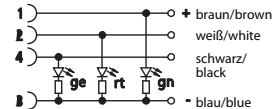



Be Certain with Belden

M12-Round-Plug Connector, Double-Ended Cordsets, According to IEC 61076-2-101
RST-RKWT/LED

Technical Data

Environmental

Degree of protection IP 67 / NEMA 6P
Operating temperature range -25°C (-13°F) / +80°C (+176°F)

Mechanical

Housing / Molded body TPU
Insert TPU
Contact RST: CuSn, pre-nickeled and 0.8 microns gold-plated
RKWT/LED: CuSn, pre-nickeled and 0.3 microns gold-plated
Coupling nut CuZn, nickel-plated
O-ring FKM (only RKWT/LED)

Electrical

Nominal current at 40°C 4 A
Nominal voltage 10–30 V DC
Rated voltage 32 V
Insulation resistance > 10⁹ Ω
Pollution degree 3

Cable Specifications

Cable No.	Outer Jacket	Conductor Size	Jacket Color	OD
224	PUR, halogen-free	3 x 0.34 mm ²	Black	.169" (4.3 mm)
225	PUR, halogen-free	4 x 0.34 mm ²	Black	.185" (4.7 mm)
251	PUR, halogen-free welding spark proof	4 x 0.34 mm ²	Orange	.185" (4.7 mm)
260	PUR, halogen-free welding spark proof	3 x 0.34 mm ²	Orange	.177" (4.5 mm)

Part Number	Pins	Outer Jacket	Standard Cable Lengths	Characteristics
RST 3-RKWT/LED A 4-3-224/...M	3	PUR, halogen-free	0.3 M / 0.6 M / 1 M / 1.5 M / 2 M / 5 M	
RST 3-RKWT/LED A 4-3-260/...M		PUR, halogen-free	0.3 M / 0.6 M / 1 M / 1.5 M / 2 M / 5 M	
RST 4-RKWT/LED P 4-225/...M	4	PUR, halogen-free, weld spark proof	0.3 M / 0.6 M / 1 M / 1.5 M / 2 M / 5 M	
RST 4-RKWT/LED P 4-251/...M		PUR, halogen-free	0.3 M / 0.6 M / 1 M / 1.5 M / 2 M / 5 M	
RST 4-RKWT/LED R 4-251/...M	4	PUR, halogen-free, weld spark proof	0.3 M / 0.6 M / 1 M / 1.5 M / 2 M / 5 M	

M12-Round-Plug Connector, Double-Ended Cordsets, According to IEC 61076-2-101

PRST-PRKT | PRST-PRKWT



4-Poles (Stainless Steel)

Actuator/sensor cordset, double-ended, M12, 4-poles, male straight to female straight connector with threaded joint and molded cable, hexagon screw in stainless steel.

– especially designed for use in food processing equipment applications –

PRST-PRKT

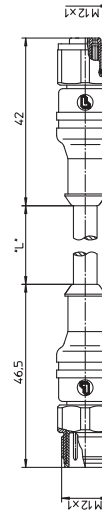

Actuator/sensor cordset, double-ended, M12, 4-poles, male straight to female 90° connector with threaded joint and molded cable, hexagon screw in stainless steel.

– especially designed for use in food processing equipment applications –

PRST-PRKWT

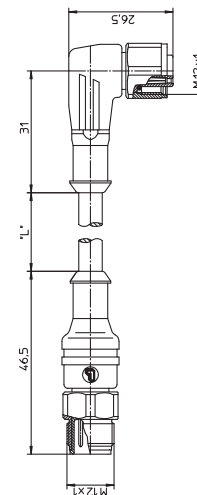

Pin Assignments

M12 - Male

4 poles

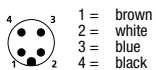

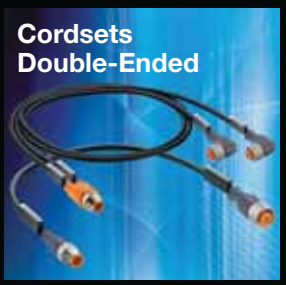

Be Certain with Belden

M12-Round-Plug Connector, Double-Ended Cordsets, According to IEC 61076-2-101
PRST-PRKT | PRST-PRKWT

Technical Data

Environmental

Degree of protection IP 67 / IP 69K / NEMA 6P
Operating temperature range -25°C (-13°F) / +70°C (+158°F)

Mechanical



Housing / Molded body TPU
Insert TPU
Contact CuSn, pre-nickel and 0.3 microns gold-plated
Coupling nut stainless steel

Electrical

Contact resistance ≤ 5 mΩ
Nominal current at 40°C 4 A
Nominal voltage 240 V
Rated voltage 250 V
Test voltage 2.0 kV eff. / 60 s
Insulation resistance > 10⁹ Ω
Pollution degree 3

Cable Specifications

Cable No.	Outer Jacket	Conductor Size	Jacket Color	OD
07	PVC	4 x 0.75 mm ²	Orange	.197" (5.0 mm)

Part Number	Part Number	Pins	Outer Jacket	Standard Cable Lengths	Characteristics
PRST 4-PRKT 4-07/...M	PRST 4-PRKWT 4-07/...M	4	PVC	2 M / 5 M	  

M12-Round-Plug Connector, Double-Ended Cordsets, According to IEC 61076-2-101

PRST-PRKWT/LED



4-Poles (Stainless Steel)

Actuator/sensor cordset, double-ended, M12, 4-poles, male straight to female 90° connector with LED operation and function indicator, threaded joint and molded cable, hexagon screw in stainless steel.

– especially designed for use in food processing equipment applications –

PRST-PRKWT/LED

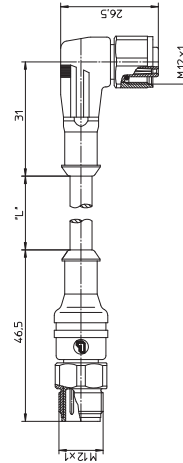

Pin Assignments

M12 - Male

4 poles

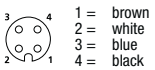

Wiring Diagrams

P pnp normally closed/open = yellow-yellow-green

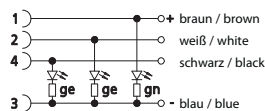

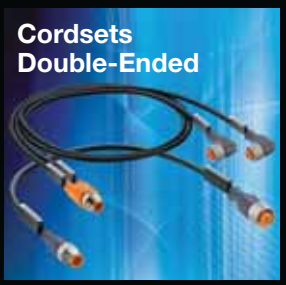

Be Certain with Belden

M12-Round-Plug Connector, Double-Ended Cordsets, According to IEC 61076-2-101
PRST-PRKWT/LED

Technical Data

Environmental

Degree of protection IP 67 / IP 69K / NEMA 6P
Operating temperature range -25°C (-13°F) / +70°C (+158°F)

Mechanical



Housing / Molded body TPU
Insert TPU
Contact CuSn, pre-nickel and 0.3 microns gold-plated
Coupling nut stainless steel

Electrical

Contact resistance ≤ 5 mΩ
Nominal current at 40°C 4 A
Nominal voltage 10-30 V DC
Rated voltage 32 V
Insulation resistance > 10⁹ Ω
Pollution degree 3

Cable Specifications

Cable No.	Outer Jacket	Conductor Size	Jacket Color	OD
07	PVC	4 x 0.75 mm ²	Orange	.197" (5.0 mm)

Part Number	Pins	Outer Jacket	Standard Cable Lengths	Characteristics
PRST 4-PRKWT/LED P 4-07/...M	4	PVC	2 M / 5 M	  

1/2"-20-Round-Plug Connector, Double-Ended Cordsets, Automotive Color Code

RST...U-RKT ...U | RST...U-RKWT...U



3, 4-, and 5-Poles

1/2"-20 actuator/sensor cordsets, double-ended, 3-, 4- and 5-Poles, male to female straight connector, dual keyway, 18 and 22 gauge, Automotive color code.

RST...U-RKT...U

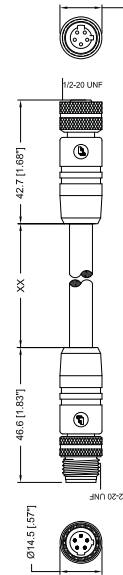

1/2"-20 actuator/sensor cordsets, double-ended, 3-, 4- and 5-Poles, male to female 90° connector, dual keyway, 18 and 22 gauge, Automotive color code.

RST...U-RKWT...U

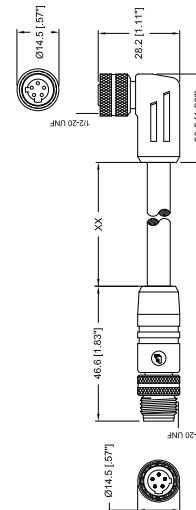

Pin Assignments

1/2"-20 - Male / Female

3 poles

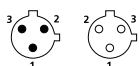

1 = green
2 = red/black
3 = red/white

4 poles

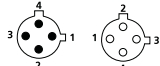

1 = red/black
2 = red/white
3 = red
4 = green

5 poles

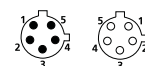

1 = red/white tr.
2 = red
3 = green
4 = red/yel tr.
5 = red/blk tr.



Be Certain with Belden

1/2"-20-Round-Plug Connector, Single-Ended Cordsets, Automotive Color Code RST...U-RKT...U | RST...U-RKWT...U

Technical Data

Environmental

Degree of protection IP 67 / NEMA 6P
Operating temperature range -40°C (-40°F) / +90°C (+194°F)

Mechanical

Housing / Molded body TPU, yellow
Insert TPU, yellow
Contact CuZn, gold over nickel plated
Coupling nut CuZn, nickel-plated

Electrical

Current rating 4 A
Voltage rating 250 V

Cable Specifications - Automotive Color Code

Cable No.	Outer Jacket	Gauge	Conductor Size	Jacket Color	OD
688	PVC	18AWG	3 x 0.75mm ²	Yellow	.290" (7.4 mm)
689	PVC	18AWG	4 x 0.75mm ²	Yellow	.290" (7.4 mm)
755	TPE	18AWG	5 x 0.75mm ²	Yellow	.333" (8.5 mm)
618	PVC	22AWG	3 x 0.34mm ²	Yellow	.180" (4.6 mm)
674	PVC	22AWG	4 x 0.34mm ²	Yellow	.190" (4.8 mm)
673	PVC	22AWG	5 x 0.34mm ²	Yellow	.210" (5.3 mm)
664	PUR	22AWG	3 x 0.34mm ²	Yellow	.190" (4.8 mm)

Part Number	Pins	Outer Jacket	Standard Cable Lengths	Characteristics
RST 3U-RKT 3U-688/...F RST 3U-RKWT 3U-688/...F	3	PVC	3 F / 6 F / 12 F / 15 F	
RST 4U-RKT 4U-689/...F RST 4U-RKWT 4U-689/...F	4	PVC	3 F / 6 F / 12 F / 15 F	
RST 5U-RKT 5U-755/...F RST 5U-RKWT 5U-755/...F	5	TPE	3 F / 6 F / 12 F / 15 F	
RST 3U-RKT 3U-618/...F RST 3U-RKWT 3U-618/...F	3	PVC	3 F / 6 F / 12 F / 15 F	
RST 4U-RKT 4U-674/...F RST 4U-RKWT 4U-674/...F	4	PVC	3 F / 6 F / 12 F / 15 F	
RST 5U-RKT 5U-673/...F RST 5U-RKWT 5U-673/...F	5	PVC	3 F / 6 F / 12 F / 15 F	
RST 3U-RKT 3U-664/...F RST 3U-RKWT 3U-664/...F	3	PUR	3 F / 6 F / 12 F / 15 F	

1/2"-20-Round-Plug Connector, Double-Ended Cordsets, US Color Code

RST...U-RKT ...U | RST...U-RKWT...U



3-Poles

1/2"-20 actuator/sensor-cordsets, double ended, 3-poles, male to female straight connector, dual keyway, 18 gauge, US color code.

RST...U-RKT...U

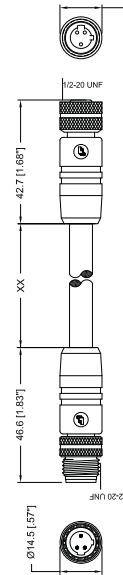

1/2"-20 actuator/sensor-cordsets, single ended, 3-poles, male to female 90° connector, dual keyway, 18 gauge, US color code.

RST...U-RKWT...U

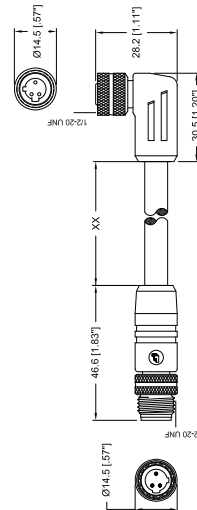

Pin Assignments

1/2"-20 - Male / Female

3 poles

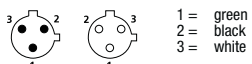

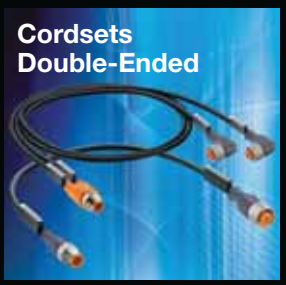

Be Certain with Belden

1/2"-20-Round-Plug Connector, Double-Ended Cordsets, US Color Code
 RST...U-RKT...U | RST...U-RKWT...U

Technical Data

Environmental

Degree of protection IP 67 / NEMA 6P
 Operating temperature range -40°C (-40°F) / +90°C (+194°F)

Mechanical



Housing / Molded body TPU, yellow
 Insert TPU, yellow
 Contact CuZn, gold over nickel plated
 Coupling nut CuZn, nickel-plated

Electrical

Current rating 4 A
 Voltage rating 250 V

Cable Specifications - US Color Code

Cable No.	Outer Jacket	Gauge	Conductor Size	Jacket Color	OD
619	CPE	18AWG	3 x 0.75mm ²	Yellow	.370" (9.4 mm)

Part Number	Pins	Outer Jacket	Standard Cable Lengths	Characteristics
RST 3U-RKT 3U-619/...F RST 3U-RKWT 3U-619/...F	3	CPE	3 F / 6 F / 12 F / 15 F	  

Cordsets Double-Ended

Mini, 7/8"-Round-Plug Connector, Double-Ended Cordsets, US Color Code

RSRK 201...601A | RSRKW 201...601A



2-, 3-, 4-, 5-, and 6-Poles

Mini, 7/8" double-ended cordsets, male to female straight, 2-, 3-, 4-, 5-, and 6-poles with molded cable, US color code.

RSRK

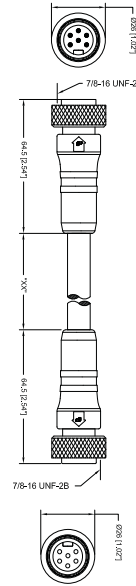

Mini, 7/8" double-ended cordsets, male straight to female 90°, 2-, 3-, 4-, 5-, and 6-poles with molded cable, US color code.

RSRKW

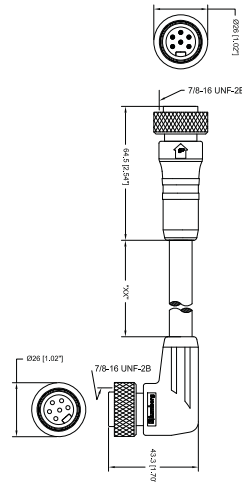

Pin Assignments

Mini, 7/8" - Male / Female

2 poles

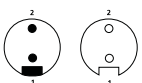

1 = white
2 = black

3 poles

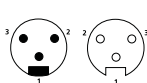

1 = green
2 = black
3 = white

4 poles

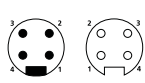

1 = black
2 = white
3 = red
4 = green

5 poles

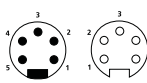

1 = white
2 = red
3 = green
4 = orange
5 = black

6 poles

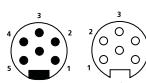

1 = white
2 = red
3 = green
4 = orange
5 = black
6 = blue



Be Certain with Belden

Mini, 7/8"-Round-Plug Connector, Double-Ended Cordsets, US Color Code
RSRK 201...601A | RSRKW 201...601A

Technical Data

Environmental

Degree of protection IP 67 / NEMA 6P
Operating temperature range -40°C (-40°F) / +90°C (194°F)

Mechanical

















Housing / Molded body TPU, yellow
Insert TPU, yellow
Contact CuZn, gold over silver plated
Coupling nut Aluminum, anodized black

Electrical

Current rating 2 pole: 12 A
3-6 pole: 8 A
Voltage rating 600 V

Cable Specifications - US Color Code

Cable No.	Outer Jacket	Gauge	Jacket Color	OD	Temperature Rating	Agency Approvals
678	PVC	16AWG	Yellow	.375" (9.5 mm)	-40°C (-40°F) to +105°C (221°F)	UL: STOW / CSA: ST0
619	CPE	18AWG	Yellow	.370" (9.4 mm)	-40°C (-40°F) to +90°C (194°F)	UL: S00W / CSA: S0W
738	TPE	16AWG	Yellow	.390" (9.9 mm)	-50°C (-58°F) to +105°C (221°F)	UL: SE00W / CSA: ST00W
739	TPE	16AWG	Yellow	.415" (10.5 mm)	-50°C (-58°F) to +105°C (221°F)	UL: SE00W / CSA: ST00W
777	TPE	16AWG	Yellow	.495" (12.6 mm)	-50°C (-58°F) to +105°C (221°F)	UL: SE00W / CSA: ST00W
697	PVC	18AWG	Yellow	.502" (12.8 mm)	-40°C (-40°F) to +105°C (221°F)	UL: ST0W / CSA: ST00

Part Number	Pins	Outer Jacket	Standard Cable Lengths	Characteristics
RSRK 201-678/...F RSRKW 201-678/...F	2	PVC	6 F / 12 F / 15 F / 20 F / 30 F	  
RSRK 301-619/...F RSRKW 301-619/...F	3	CPE	6 F / 12 F / 15 F / 20 F / 30 F	  
RSRK 301-738/...F RSRKW 301-738/...F		TPE	6 F / 12 F / 15 F / 20 F / 30 F	  
RSRK 401-739/...F RSRKW 401-739/...F	4	TPE	6 F / 12 F / 15 F / 20 F / 30 F	  
RSRK 501-777/...F RSRKW 501-777/...F	5	TPE	6 F / 12 F / 15 F / 20 F / 30 F	  
RSRK 601A-697/...F RSRKW 601A-697/...F	6	PVC	6 F / 12 F / 15 F / 20 F / 30 F	 

Mini, 7/8"-Round-Plug Connector, Double-Ended Cordsets, Automotive Color Code

RSRK 301...501 | RSRKW 301...501



3- and 5-Poles

Mini, 7/8" double-ended cordsets, male to female straight, 3- and 5-poles with molded cable, Automotive color code.

RSRK

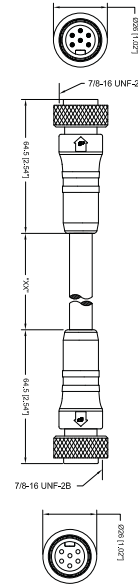

Mini, 7/8" double-ended cordsets, male straight to female 90°, 3- and 6-poles with molded cable, Automotive color code.

RSRKW

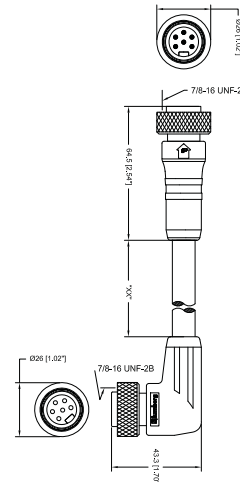

Pin Assignments

Mini, 7/8" - Male / Female

3 poles

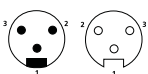

- 1 = green
- 2 = red w/black tr.
- 3 = red w/white tr.

5 poles (742)

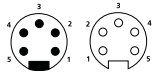

- 1 = red w/white tr.
- 2 = red
- 3 = green
- 4 = red w/orange tr.
- 5 = red w/black tr.

5 poles (755)

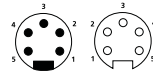

- 1 = red w/white tr.
- 2 = red
- 3 = green
- 4 = red w/yellow tr.
- 5 = red w/black tr.

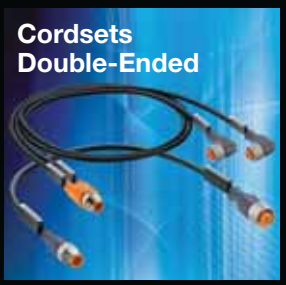

Be Certain with Belden

Mini, 7/8"-Round-Plug Connector, Double-Ended Cordsets, Automotive Color Code
 RSRK 301...501 | RSRKW 30...50

Technical Data

Environmental

Degree of protection IP 67 / NEMA 6P
 Operating temperature range -40°C (-40°F) / +90°C (194°F)

Mechanical













Housing / Molded body TPU, yellow
 Insert TPU, yellow
 Contact CuZn, gold over silver plated
 Coupling nut Aluminum, anodized black

Electrical

Current rating 741/742: 8 A
 755: 5.6 A
 Voltage rating 741/742: 600 V
 755: 300 V

Cable Specifications - Automotive Color Code

Cable No.	Outer Jacket	Gauge	Jacket Color	OD	Temperature Rating	Agency Approvals
741	TPE	16AWG	Yellow	.390" (9.9 mm)	-40°C (-40°F) to +105°C (221°F)	UL: SE00W / CSA: ST00W
742	TPE	16AWG	Yellow	.495" (12.6 mm)	-40°C (-40°F) to +105°C (221°F)	UL: SE00W / CSA: ST00W
755	TPE	18AWG	Yellow	.333" (8.5 mm)	-40°C (-40°F) to +90°C (194°F)	UL: PLTC / CSA: AWM I/II, A/B

Part Number	Pins	Outer Jacket	Standard Cable Lengths	Characteristics
RSRK 301-741/...F	3	TPE	6 F / 12 F / 15 F / 20 F / 30 F	   
RSRK 501-742/...F	5	TPE	6 F / 12 F / 15 F / 20 F / 30 F	   
RSRK 501-755/...F	5	TPE	6 F / 12 F / 15 F / 20 F / 30 F	   

Mini, 7/8"-Round-Plug Connector, Double-Ended Cordsets, IEC Color Code

RSRK 20...50 | RSRKW 20...50



2-, 3-, 4- and 5-Poles

Mini, 7/8" double-ended cordsets, male straight with external threads to female straight connector, 2-, 3-, 4-, and 5-poles with molded cable, IEC color code.



Mini, 7/8" double-ended cordsets, male straight with external threads to female 90° connector, 2-, 3-, 4-, and 5-poles with molded cable, IEC color code.

RSRK

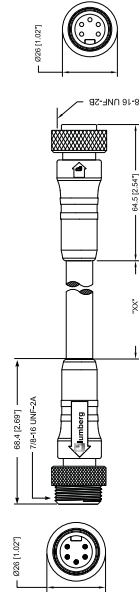

RSRKW

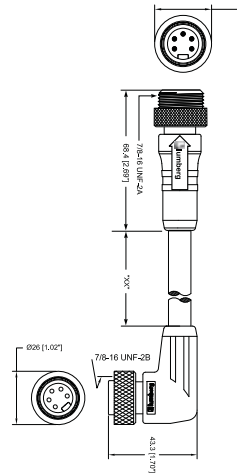

Pin Assignments

Mini, 7/8" - Male / Female

2 poles

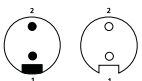

1 = brown
2 = blue

3 poles

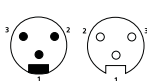

1 = green
2 = brown
3 = blue

4 poles

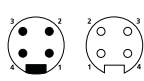

1 = black
2 = blue
3 = brown
4 = white

5 poles

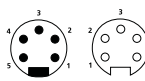

1 = black
2 = blue
3 = yellow w/green tr.
4 = brown
5 = white

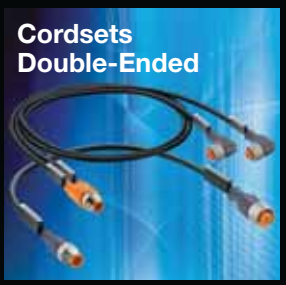

Be Certain with Belden

Mini, 7/8"-Round-Plug Connector, Double-Ended Cordsets, IEC Color Code RSRK 20...50 | RSRKW 20...50

Technical Data

Environmental

Degree of protection IP 67 / NEMA 6P
 Operating temperature range -40°C (-40°F) / +90°C (194°F)

Mechanical

Housing / Molded body TPU, yellow
 Insert TPU, yellow
 Contact CuZn, gold over silver plated
 Coupling nut Aluminum, anodized black

Electrical

Current rating 2-3 pole: 8 A
 4-5 pole: 5.6 A
 Voltage rating 300 V

Cable Specifications - IEC Color Code

Cable No.	Outer Jacket	Gauge	Jacket Color	OD	Temperature Rating	Agency Approvals
603	PVC	18AWG	Yellow	.290" (7.4 mm)	-40°C (-40°F) to +105°C (221°F)	UL: AWM 2661 / CSA: AWM I/II A/B
731	TPE	18AWG	Yellow	.284" (7.2 mm)	-50°C (-58°F) to +90°C (194°F)	UL: PLTC / CSA: AWM I/II A/B
645	PUR	18AWG	Yellow	.220" (5.6 mm)	-40°C (-40°F) to +80°C (176°F)	UL: AWM 20233 / CSA: AWM I/II A/B
637	TPE	18AWG	Yellow	.280" (7.1 mm)	-25°C (-40°F) to +105°C (221°F)	UL: PLTC / CSA: AWM I/II A/B
602	PUR	18AWG	Yellow	.230" (5.8 mm)	-40°C (-40°F) to +80°C (176°F)	UL: AWM 20233 / CSA: AWM I/II A/B
794	TPE	18AWG	Yellow	.304" (7.7 mm)	-50°C (-58°F) to +90°C (194°F)	UL: PLTC / CSA: AWM I/II A/B

Part Number	Outer Jacket	Pins	Standard Cable Lengths	Characteristics
RSRK 20-603/...M	RSRKW 20-603/...M	2	0.3 M / 0.6 M / 1 M / 2 M / 5 M	
RSRK 30-731/...F	RSRKW 30-731/...F	3	6 F / 12 F / 15 F / 20 F / 30 F	
RSRK 30-645/...M	RSRKW 30-645/...M		0.3 M / 0.6 M / 1 M / 2 M / 5 M	
RSRK 40-637/...F	RSRKW 40-637/...F	4	6 F / 12 F / 15 F / 20 F / 30 F	
RSRK 40-602/...M	RSRKW 40-602/...M		0.3 M / 0.6 M / 1 M / 2 M / 5 M	
RSRK 50-794/...F	RSRKW 50-794/...F	5	6 F / 12 F / 15 F / 20 F / 30 F	

Mini, 7/8"-Round-Plug Connector, Double-Ended Cordsets, EURO AC Color Code

RSRK 30 | RSRKW 30



3-Poles

Mini, 7/8" double-ended cordsets, male straight with external threads to female straight connector, 3-poles with molded cable, IEC color code.

RSRK

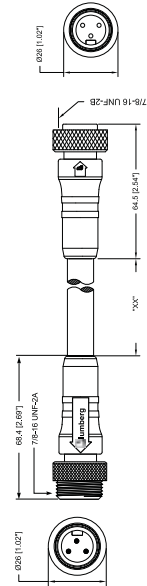

Mini, 7/8" double-ended cordsets, male straight with external threads to female 90° connector, 3-poles with molded cable, IEC color code.

RSRKW

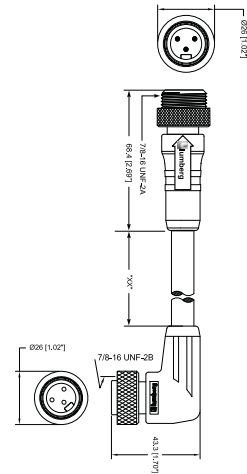

Pin Assignments

Mini, 7/8" - Male / Female

3 poles

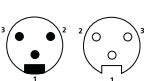

- 1 = yellow/green
- 2 = brown
- 3 = blue

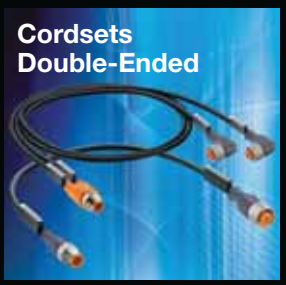

Be Certain with Belden

Mini, 7/8"-Round-Plug Connector, Double-Ended Cordsets, EURO AC Color Code
RSRK 30 | RSRKW 30

Technical Data

Environmental

Degree of protection IP 67 / NEMA 6P
Operating temperature range -40°C (-40°F) / +90°C (194°F)

Mechanical

Housing / Molded body TPU, yellow
Insert TPU, yellow
Contact CuZn, gold over silver plated
Coupling nut Aluminum, anodized black



Electrical

Current rating 8 A
Voltage rating 300 V

Cable Specifications - EURO AC Color Code

Cable No.	Outer Jacket	Gauge	Jacket Color	OD	Temperature Rating	Agency Approvals
601	PVC	18AWG	Yellow	.290" (7.4 mm)	-40°C (-40°F) to +105°C (221°F)	UL: AWM 2661 / CSA: AWM I/II A/B

Cordsets
Double-Ended

Part Number	Pins	Outer Jacket	Standard Cable Lengths	Characteristics
RSRK 30-601/...M RSRKW 30-601/...M	3	PVC	2 M / 5 M / 10 M	  

Mini, 1"-Round-Plug Connector, Double-Ended Cordsets, US Color Code

RSRK 601B...801M



6-, 7- and 8-Poles

Mini, 1" double-ended cordsets, male straight to female straight connector, 6-, 7- and 8-poles with molded cable, US color code.

RSRK

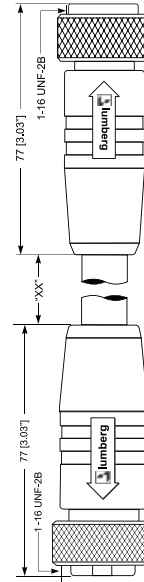

Pin Assignments

Mini, 1" - Male / Female

6 poles

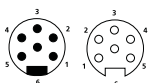

- 1 = orange
- 2 = blue
- 3 = black
- 4 = white
- 5 = red
- 6 = green

7 poles

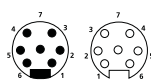

- 1 = white/black
- 2 = black
- 3 = white
- 4 = red
- 5 = orange
- 6 = blue
- 7 = green

8 poles

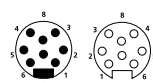

- 1 = orange
- 2 = blue
- 3 = white/black
- 4 = black
- 5 = white
- 6 = red
- 7 = green
- 8 = red/black



Be Certain with Belden

Mini, 1”-Round-Plug Connector, Double-Ended Cordsets, US Color Code
RSRK 601B...801M

Technical Data

Environmental

Degree of protection IP 67 / NEMA 6P
Operating temperature range -40°C (-40°F) / +90°C (194°F)

Mechanical

Housing / Molded body TPU, yellow
Insert TPU, yellow
Contact CuZn, gold over silver plated
Coupling nut Aluminum, anodized black

Electrical

Current rating 6 and 7 pole: 8 A
8 pole: 7 A
Voltage rating 600 V

Cable Specifications - US Color Code

Cable No.	Outer Jacket	Gauge	Jacket Color	OD	Temperature Rating	Agency Approvals
696	PVC	16AWG	Yellow	.560" (14.2 mm)	-40°C (-40°F) to +105°C (221°F)	UL: STOW / CSA: STO
622	PVC	16AWG	Yellow	.560" (14.2 mm)	-40°C (-40°F) to +105°C (221°F)	UL: STOW / CSA: STO
698	PVC	16AWG	Yellow	.585" (14.9 mm)	-40°C (-40°F) to +105°C (221°F)	UL: STOW / CSA: STO

Part Number	Pins	Outer Jacket	Standard Cable Lengths	Characteristics
RSRK 601B-696/...F	6	PVC	6 F / 12 F / 15 F / 20 F / 30 F	
RSRK 701M-622/...F	7	PVC	6 F / 12 F / 15 F / 20 F / 30 F	
RSRK 801M-698/...F	8	PVC	6 F / 12 F / 15 F / 20 F / 30 F	

Mini, 1"-Round-Plug Connector, Double-Ended Cordsets, US Color Code

RSRK 701B...801M



7- and 8-Poles

Mini, 1" double-ended cordsets, male straight to female straight connector, 7- and 8-poles with molded cable, US color code.

RSRK

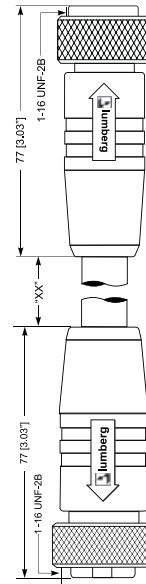

Pin Assignments

Mini, 1" - Male / Female

7 poles

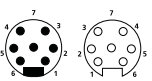

- 1 = white/black
- 2 = black
- 3 = white
- 4 = red
- 5 = orange
- 6 = blue
- 7 = green

8 poles

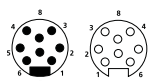

- 1 = orange
- 2 = blue
- 3 = white/black
- 4 = black
- 5 = white
- 6 = red
- 7 = green
- 8 = red/black



Be Certain with Belden

Mini, 1”-Round-Plug Connector, Double-Ended Cordsets, US Color Code
RSRK 701M...801M

Technical Data

Environmental

Degree of protection IP 67 / NEMA 6P
Operating temperature range -40°C (-40°F) / +90°C (194°F)

Mechanical

Housing / Molded body TPU, yellow
Insert TPU, yellow
Contact CuZn, gold over silver plated
Coupling nut Aluminum, anodized black

Electrical

Current rating 7 pole: 8 A
8 pole: 7 A
Voltage rating 300 V

Cable Specifications - US Color Code

Cable No.	Outer Jacket	Gauge	Jacket Color	OD	Temperature Rating	Agency Approvals
649	PUR	18AWG	Yellow	.270" (6.9 mm)	-40°C (-40°F) to +80°C (176°F)	UL: AWM 20233 / CSA: AWM I/II A/B
650	PUR	18AWG	Yellow	.292" (7.4 mm)	-40°C (-40°F) to +80°C (176°F)	UL: AWM 20233 / CSA: AWM I/II A/B

Part Number	Pins	Outer Jacket	Standard Cable Lengths	Characteristics
RSRK 701M-649/...F	7	PUR	6 F / 12 F / 15 F / 20 F / 30 F	
RSRK 801M-650/...M	8	PUR	6 F / 12 F / 15 F / 20 F / 30 F	

RSRK 1201M



Mini, 1 1/8"-Round-Plug Connector, Double-Ended Cordsets, IEC Color Code

12-Poles

Mini, 1 1/8" double-ended cordsets, male straight to female straight connector, 12-poles with molded cable, IEC color code.

RSRK

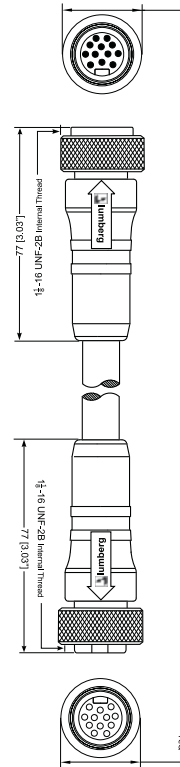

Pin Assignments

Mini, 1 1/8" - Male / Female

12 poles

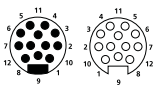

- 1 = black
- 2 = red
- 3 = pink
- 4 = grey
- 5 = yellow
- 6 = green
- 7 = white
- 8 = violet
- 9 = green/yellow
- 10 = blue
- 11 = n.c.
- 12 = brown

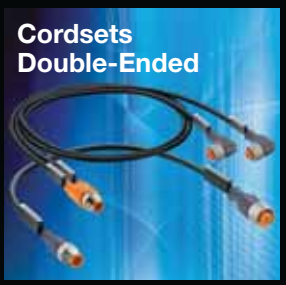

Be Certain with Belden

Mini, 1 1/8"-Round-Plug Connector, Double-Ended Cordsets, IEC Color Code
RSRK 1201M

Technical Data

Environmental

Degree of protection IP 67 / NEMA 6P
Operating temperature range -40°C (-40°F) / +90°C (194°F)

Mechanical





Housing / Molded body TPU, yellow
Insert TPU, yellow
Contact CuZn, gold over silver plated
Coupling nut Aluminum, anodized black

Electrical

Current rating 5 A
Voltage rating 600 V

Cable Specifications - IEC Color Code

Cable No.	Outer Jacket	Gauge	Jacket Color	OD	Temperature Rating	Agency Approvals
728	TPE	18AWG	Yellow	.596" (15.1 mm)	-50°C (-58°F) to +90°C (194°F)	UL: SE00W / CSA: ST00W

Part Number	Pins	Outer Jacket	Standard Cable Lengths	Characteristics
RSRK 1201M-728/...F	12	TPE	6 F / 12 F / 15 F / 20 F / 30 F	   

Mini, 1 1/8"-Round-Plug Connector, Double-Ended Cordsets, US Color Code

RSRK 901M...1201M



9-, 10-, and 12-Poles

Mini, 1 1/8" double-ended cordsets, male straight to female straight connector, 9-, 10-, and 12-poles with molded cable, US color code.

RSRK

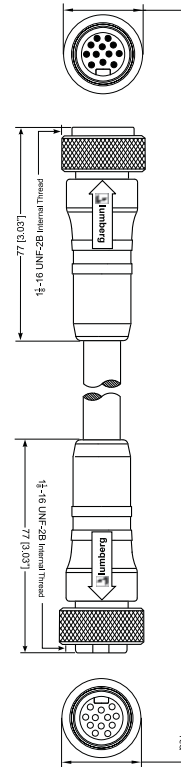

Pin Assignments

Mini, 1 1/8" - Male / Female

9 poles

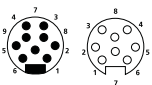

- 1 = orange
- 2 = blue
- 3 = red/black
- 4 = green/black
- 5 = white
- 6 = red
- 7 = green
- 8 = white/black
- 9 = black

10 poles

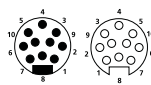

- 1 = orange
- 2 = blue
- 3 = white/black
- 4 = red/black
- 5 = green/black
- 6 = orange/black
- 7 = red
- 8 = green
- 9 = black
- 10 = white

12 poles

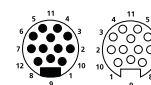

- 1 = orange
- 2 = blue
- 3 = white/black
- 4 = red/black
- 5 = green/black
- 6 = orange/black
- 7 = blue/black
- 8 = black/white
- 9 = green
- 10 = red
- 11 = white
- 12 = black

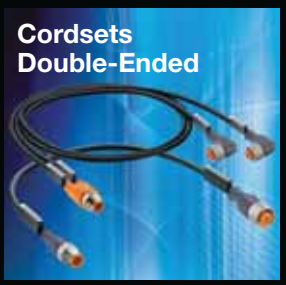

Be Certain with Belden

Mini, 1 1/8"-Round-Plug Connector, Double-Ended Cordsets, US Color Code
RSRK 901M...1201M

Technical Data

Environmental

Degree of protection IP 67 / NEMA 6P
Operating temperature range -40°C (-40°F) / +90°C (194°F)

Mechanical

Housing / Molded body TPU, yellow
Insert TPU, yellow
Contact CuZn, gold over silver plated
Coupling nut Aluminum, anodized black

Electrical

Current rating 9-10 pole: 7 A
12 pole: 5 A
Voltage rating 623, 699, 724: 600 V
651, 652, 654: 300 V

Cable Specifications - US Color Code

Cable No.	Outer Jacket	Gauge	Jacket Color	OD	Temperature Rating	Agency Approvals
623	PVC	16AWG	Yellow	.660" (16.8 mm)	-40°C (-40°F) to +90°C (194°F)	UL: STOW / CSA: AWM I/II A/B
651	PUR	18AWG	Yellow	.313" (8.0 mm)	-40°C (-40°F) to +80°C (176°F)	UL: AWM 20233 / CSA: AWM I/II A/B
699	PVC	16AWG	Yellow	.660" (16.8 mm)	-40°C (-40°F) to +90°C (194°F)	UL: STOW / CSA: AWM I/II A/B
652	PUR	18AWG	Yellow	.340" (8.6 mm)	-40°C (-40°F) to +80°C (176°F)	UL: AWM 20233 / CSA: AWM I/II A/B
724	TPE	16AWG	Yellow	.690" (17.5 mm)	-50°C (-58°F) to +90°C (194°F)	UL: SE00W / CSA: STOW
654	PUR	18AWG	Yellow	.354" (9.0 mm)	-40°C (-40°F) to +80°C (176°F)	UL: AWM 20233 / CSA: AWM I/II A/B

Part Number	Pins	Outer Jacket	Standard Cable Lengths	Characteristics
RSRK 901M-623/...F	9	PVC	6 F / 12 F / 15 F / 20 F / 30 F	
RSRK 901M-651/...F				
RSRK 1001M-699/...F	10	PVC	6 F / 12 F / 15 F / 20 F / 30 F	
RSRK 1001M-652/...F				
RSRK 1201M-724/...F	12	TPE	6 F / 12 F / 15 F / 20 F / 30 F	
RSRK 1201M-654/...F				

Mini, 1 1/8"-Round-Plug Connector, Double-Ended Cordsets, Numeric Color Code

RSRK 1201M...1901M



12-, and 19-Poles

Mini, 1 1/8" double-ended cordsets, male straight to female straight connector, 12-, and 19-poles with molded cable, Numeric color code.

RSRK

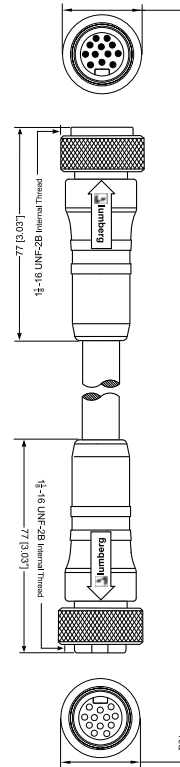

Pin Assignments

Mini, 1 1/8" - Male / Female

12 poles

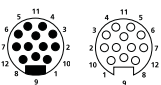

- 1 = black w/ number "1"
- 2 = black w/ number "2"
- 3 = black w/ number "3"
- 4 = black w/ number "4"
- 5 = black w/ number "5"
- 6 = black w/ number "6"
- 7 = black w/ number "7"
- 8 = black w/ number "8"
- 9 = green w/yellow tracer
- 10 = black w/ number "10"
- 11 = black w/ number "11"
- 12 = black w/ number "12"

19 poles

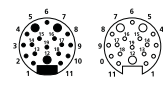

- 1 = black w/ number "1"
- 2 = black w/ number "2"
- 3 = black w/ number "3"
- 4 = black w/ number "4"
- 5 = black w/ number "5"
- 6 = black w/ number "6"
- 7 = black w/ number "7"
- 8 = black w/ number "8"
- 9 = black w/ number "9"
- 10 = black w/ number "10"
- 11 = black w/ number "11"
- 12 = green w/yellow tracer
- 13 = black w/ number "13"
- 14 = black w/ number "14"
- 15 = black w/ number "15"
- 16 = black w/ number "16"
- 17 = black w/ number "17"
- 18 = black w/ number "18"
- 19 = black w/ number "19"

19 poles - current rating

- 1-4, 6, 8-11, and 13-19 = 3 A
- 5 and 7 = 8 A
- 12 = Ground

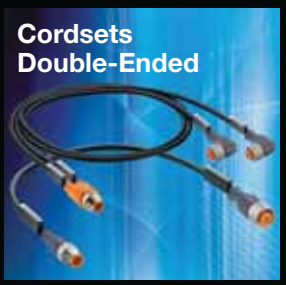

Be Certain with Belden

Mini, 1 1/8"-Round-Plug Connector, Double-Ended Cordsets, Numeric Color Code
RSRK 1201M...1901M

Technical Data

Environmental

Degree of protection IP 67 / NEMA 6P
Operating temperature range -40°C (-40°F) / +90°C (194°F)

Mechanical







Housing / Molded body TPU, yellow
Insert TPU, yellow
Contact CuZn, gold over silver plated
Coupling nut Aluminum, anodized black

Electrical

Current rating 12 poles: 5 A
19 poles: see pin assignments
Voltage rating 300 V

Cable Specifications - Numeric Color Code

Cable No.	Outer Jacket	Gauge	Jacket Color	OD	Temperature Rating	Agency Approvals
676	PUR	18AWG	Yellow	.390" (9.9 mm)	-40°C (-40°F) to +80°C (176°F)	UL: AWM 20233 / CSA: AWM I/II A/B
669	PUR	18AWG	Yellow	.489" (12.4 mm)	-40°C (-40°F) to +80°C (176°F)	UL: AWM 20233 / CSA: AWM I/II A/B

Part Number	Pins	Outer Jacket	Standard Cable Lengths	Characteristics
RSRK 1201M-676/...M	12	PUR	1 M / 2 M / 3 M / 5 M	  
RSRK 1901M-669/...M	19	PUR	2 M / 5 M	  

M23-Round-Plug Connector, Double-Ended Cordsets

RSUF-RKWU | RSWU-RKWU



19-Poles

M23 cordsets, double ended, male straight to female 90° connector, 19-poles with threaded joint, external threads and molded cable.

– control cable for actuator/
sensor boxes –

RSUF-RKWU

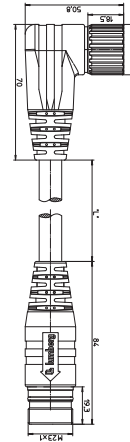

12-Poles

M23 cordsets, double ended, male 90° to female 90° connector, 12-poles with threaded joint, internal threads and molded cable.

– control cable for actuator/
sensor boxes –

RSWU/RKWU

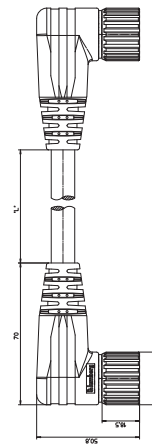

Pin Assignments

M23 - Male / Female

12 poles

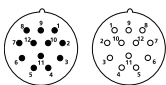

- 1 = white
- 2 = green
- 3 = yellow
- 4 = grey
- 5 = grey/pink
- 6 = red/blue
- 7 = white/green
- 8 = brown/green
- 9 = blue
- 10 = blue
- 11 = brown
- 12 = yellow/green

19 poles

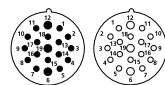

- 1 = violet
- 2 = red
- 3 = grey
- 4 = red/blue
- 5 = green
- 6 = blue
- 7 = grey/pink
- 8 = white/green
- 9 = white/yellow
- 10 = white/grey
- 11 = black
- 12 = yellow/green
- 13 = yellow/brown
- 14 = brown/green
- 15 = white
- 16 = yellow
- 17 = pink
- 18 = grey/brown
- 19 = brown



Be Certain with Belden

M23-Round-Plug Connector, Double-Ended Cordsets
RSUF-RKWU | RSWU-RKWU

Technical Data

Environmental

Degree of protection IP 67 / NEMA 6P
Operating temperature range -25°C (-13°F) / +100°C (+212°F)

Mechanical

Molded body TPU, self-extinguishing
Housing CuZn, nickel plated (only RSUF)
Insert PBT
Contact CuZn, pre-nickel and 0.8 microns gold-plated
Coupling nut CuZn, nickel-plated
O-ring FKM (only RSUF/RSWU)

Electrical

Contact resistance ≤ 5 mΩ
Nominal current at 40°C 12 poles 8 A
19 poles 8 A (pin Ø 1 mm)
10 A pin Ø 1.5 mm
Nominal voltage 12 poles 240 V
19 poles 120 V
Rated voltage 12 poles 250 V
19 poles 125 V
Test voltage 12 poles 2.5 kV eff./ 60 s
19 poles 1.5 kV eff./ 60 s
Insulation resistance > 10⁹ Ω
Pollution degree 3

Cable Specifications

Cable No.	Outer Jacket	Jacket Color	Leads	OD	Agency Approvals
256	PUR, halogen-free	Black	8 x 0.50mm ² 3 x 1.00mm ²	9.3 mm	UL: AWM 21198 / CSA: AWM I/II A/B
355	PUR	Black	3 x 1.00mm ² 16 x 0.50mm ²	11.6 mm	UL: AWM 21198 / CSA: AWM I/II A/B

Part Number	Pins	Outer Jacket	Standard Cable Lengths	Characteristics
RSUF 19-RKWU 19-355/...M	19	PUR	2 M / 5 M / 10 M	
RSWU 12-RKWU 12-256/...M	12	PUR, halogen-free	5 M / 10 M / 15 M / 20 M	

M12-Round-Plug Connector to DIN Valve Connector, Double-Ended Cordsets

RST-VAD



RST-VAD 1 A and RST-VAD 1F

Actuator cordset, double-ended, M12 male connector with self-locking threaded joint and valve connector according to

– DIN EN 175301-803, form A –

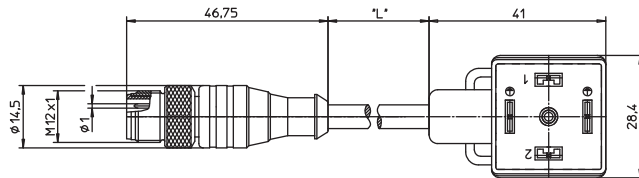

RST-VAD 3C-4-1 and RST-VAD 3C-4-2

Sensor cordset, double-ended, M12 male connector with selflocking threaded joint and connector for pressure switches according to

– DIN EN 175301-803, form A –

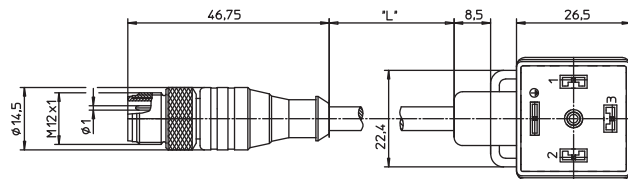

Pin Assignments

M12

3 poles

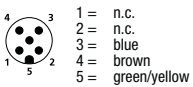

- 1 = n.c.
- 2 = n.c.
- 3 = blue
- 4 = brown
- 5 = green/yellow

VAD 1A / VAD 1F

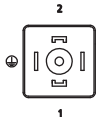

- 1 = brown
- 2 = blue
- ⊕ = green/yellow

Wiring Diagram

VAD 1A

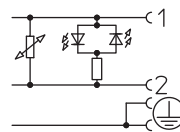

VAD 3C



5 poles

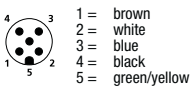

- 1 = brown
- 2 = white
- 3 = blue
- 4 = black
- 5 = green/yellow

**VAD 3C-4-1
VAD 3C-4-2**

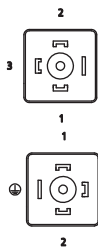

- 1 = brown
- 2 = white
- 3 = black
- LED = blue
- ⊕ = green/yellow

VAD 1F

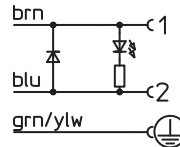



Be Certain with Belden

M12-Round-Plug Connector to DIN Valve Connector, Double-Ended Cordsets RST-VAD

Technical Data

Environmental

Degree of protection IP 67 / NEMA 6P
Operating temperature range -25°C (-13°F) / +80°C (+176°F)

Mechanical (RST)

Housing / Molded body TPU
Insert TPU
Contact CuZn, pre-nickel and 0.8 microns gold-plated
Coupling nut CuZn, nickel-plated

Mechanical (VAD)

Housing / Molded body TPU
Insert PBT
Contact CuZn, nickel/tin plated

Electrical

Nominal current at 40°C 4 A
Nominal voltage 24 V
Rated voltage 32 V
Test voltage 1.5 kV eff. / 60 s
Insulation resistance > 10⁹ Ω
Pollution degree 3

Varistor data (VAD 1A)

Nominal voltage 47 V at 0.1 mA
typ. limiting voltage 110 V at 5 A
max. pulse energy 0.9 Ws
max. continuous power loss 0.01 W
(standard impulse 10/1000us)

Recovery diode data (VAD 1F)

typ. limiting voltage 1.2 V at 4 A
max. pulse current 10 A
max. continuous power loss 0.5 W
(pulse shape 10/1000us)

Cable Specifications

Cable No.	Outer Jacket	Gauge	Jacket Color	OD	Agency Approvals
226	PUR, halogen-free	3 x 0.50 mm ²	Black	4.6 mm	UL: AWM 21198 / CSA: AWM I/II A/B
241	PUR, halogen-free, spark-proof	3 x 0.50 mm ²	Black	5.0 mm	UL: AWM 21198 / CSA: AWM I/II A/B
228	PUR, halogen-free	5 x 0.50 mm ²	Black	5.4 mm	UL: AWM 21198 / CSA: AWM I/II A/B
259	PUR, halogen-free, spark-proof	5 x 0.50 mm ²	Black	5.5 mm	UL: AWM 21198 / CSA: AWM I/II A/B

Part Number	Pins	Outer Jacket	Standard Cable Lengths	Characteristics
RST 5-3-VAD 1A-1-3-226/...M	3	PUR, halogen-free	0.3 M / 0.6 M / 1 M / 1.5 M / 2 M / 5 M	
RST 5-3-VAD 1A-1-3-241/...M		PUR, halogen-free, spark-proof	0.3 M / 0.6 M / 1 M / 1.5 M / 2 M / 5 M	
RST 5-VAD 3C-4-1-228/...M	5	PUR, halogen-free	0.3 M / 0.6 M / 1 M / 1.5 M / 2 M / 5 M	
RST 5-VAD 3C-4-1-259/...M		PUR, halogen-free, spark-proof	0.3 M / 0.6 M / 1 M / 1.5 M / 2 M / 5 M	

M12-Round-Plug Connector to DIN Valve Connector, Double-Ended Cordsets

RST-VBD | RST-VB



RST-VBD 1A-1-1 and RST-VBD 1A-1-2

Actuator cordset, double-ended, M12 male connector with self-locking threaded joint and valve connector according to

– DIN EN 175301-803, form B –

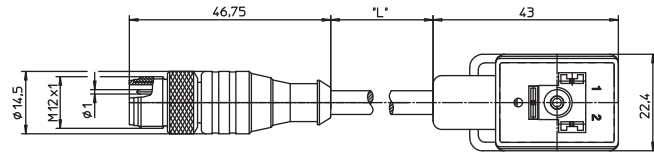

RST-VB 1A-1-1 and RST-VB 1A-1-2

Actuator cordset, double-ended, M12 male connector with self-locking threaded joint and valve connector similar to

– DIN EN 175301-803, industry standard form B –

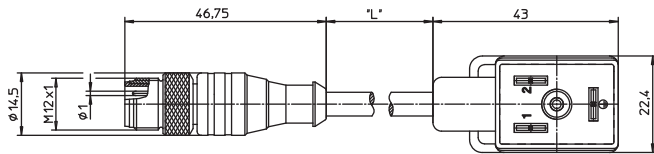

Pin Assignments

M12					Wiring Diagram	
3 poles	VBD 1A-1-1	VBD 1A-1-2	VB 1A-1-1	VB 1A-1-2		VBD 1A / VB 1A
<p>1 = n.c. 2 = n.c. 3 = blue 4 = brown 5 = green/yellow</p>					<p>1 = brown 2 = blue ⊕ = green/yellow</p>	



Be Certain with Belden

M12-Round-Plug Connector to DIN Valve Connector, Double-Ended Cordsets
RST-VBD | RST-VB

Technical Data

Environmental

Degree of protection IP 67 / NEMA 6P
Operating temperature range -25°C (-13°F) / +80°C (+176°F)

Mechanical (RST)

Housing / Molded body TPU
Insert TPU
Contact CuZn, pre-nickel and 0.8 microns gold-plated
Coupling nut CuZn, nickel-plated

Mechanical (VAD)

Housing / Molded body TPU
Insert PBT
Contact CuZn, nickel/tin plated

Electrical

Nominal current at 40°C 4 A
Nominal voltage 24 V
Rated voltage 32 V
Test voltage 1.5 kV eff. / 60 s
Insulation resistance > 10⁹ Ω
Pollution degree 3

Varistor data (VBD / VB)

Nominal voltage 47 V at 0.1 mA
typ. limiting voltage 110 V at 5 A
max. pulse energy 0.9 Ws
max. continuous power loss 0.01 W
(standard impulse 10/1000us)

Cable Specifications

Cable No.	Outer Jacket	Gauge	Jacket Color	OD	Agency Approvals
226	PUR, halogen-free	3 x 0.50 mm ²	Black	4.6 mm	UL: AWM 21198 / CSA: AWM I/II A/B
241	PUR, halogen-free, spark-proof	3 x 0.50 mm ²	Black	5.0 mm	UL: AWM 21198 / CSA: AWM I/II A/B

Part Number	Pins	Outer Jacket	Standard Cable Lengths	Characteristics
RST 5-3-VBD 1A-1-1-226/... M	3	PUR, halogen-free	0.3 M / 0.6 M / 1 M / 1.5 M / 2 M / 5 M	
RST 5-3-VBD 1A-1-1-241/... M		PUR, halogen-free, spark-proof	0.3 M / 0.6 M / 1 M / 1.5 M / 2 M / 5 M	
RST 5-3-VBD 1A-1-2-226/... M	3	PUR, halogen-free	0.3 M / 0.6 M / 1 M / 1.5 M / 2 M / 5 M	
RST 5-3-VBD 1A-1-2-241/... M		PUR, halogen-free, spark-proof	0.3 M / 0.6 M / 1 M / 1.5 M / 2 M / 5 M	

M12-Round-Plug Connector to DIN Valve Connector, Double-Ended Cordsets

RST-VCD | RST-VC



RST-VCD 1A-1-3

Actuator cordset, double-ended, M12 male connector with self-locking threaded joint and valve connector according to

– DIN EN 175301-803, form C (8.0 mm) –

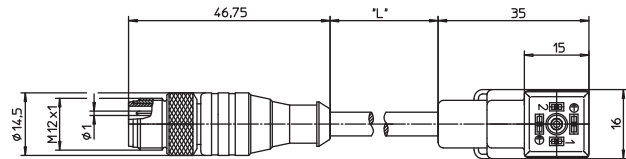

RST-VC 1A-1-3

Actuator cordset, double-ended, M12 male connector with self-locking threaded joint and valve connector similar to

– DIN EN 175301-803, industry standard form C, (9.4 mm) –

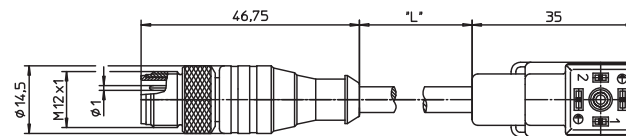

Pin Assignments

M12

3 poles

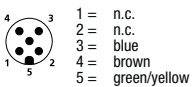

VCD 1A / VC 1A

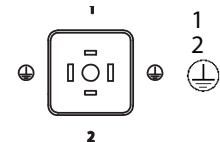

1 = brown
2 = blue
= green/yellow

Wiring Diagram

VCD 1A / VC 1A

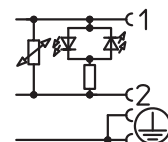

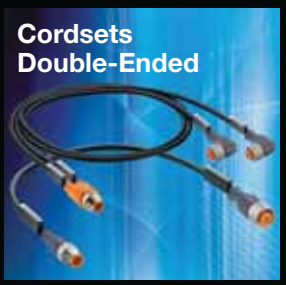

Be Certain with Belden

M12-Round-Plug Connector to DIN Valve Connector, Double-Ended Cordsets
RST-VCD | RST-VC

Technical Data

Environmental

Degree of protection IP 67 / NEMA 6P
Operating temperature range -25°C (-13°F) / +80°C (+176°F)

Mechanical (RST)

Housing / Molded body TPU
Insert TPU
Contact CuZn, pre-nickel and 0.8 microns gold-plated
Coupling nut CuZn, nickel-plated

Mechanical (VAD)

Housing / Molded body TPU
Insert PBT
Contact CuZn, nickel/tin plated

Electrical





Nominal current at 40°C 4 A
Nominal voltage 24 V
Rated voltage 32 V
Test voltage 1.5 kV eff. / 60 s
Insulation resistance > 10⁹ Ω
Pollution degree 3

Varistor data (VCD / VC)

Nominal voltage 47 V at 0.1 mA
typ. limiting voltage 110 V at 5 A
max. pulse energy 0.9 Ws
max. continuous power loss 0.01 W
(standard impulse 10/1000us)

Cable Specifications

Cable No.	Outer Jacket	Gauge	Jacket Color	OD	Agency Approvals
226	PUR, halogen-free	3 x 0.50 mm ²	Black	4.6 mm	UL: AWM 21198 / CSA: AWM I/II A/B
241	PUR, halogen-free, spark-proof	3 x 0.50 mm ²	Black	5.0 mm	UL: AWM 21198 / CSA: AWM I/II A/B

Part Number	Pins	Outer Jacket	Standard Cable Lengths	Characteristics
RST 5-3-VCD 1A-1-3-226/... M RST 5-3-VC 1A-1-3-226/... M	3	PUR, halogen-free	0.3 M / 0.6 M / 1 M / 1.5 M / 2 M / 5 M	 
RST 5-3-VCD 1A-1-3-241/... M		PUR, halogen-free, spark-proof	0.3 M / 0.6 M / 1 M / 1.5 M / 2 M / 5 M	 

M12-Splitters, Double-Ended, IEC Color Code

ASB 2-RKT | ASBA 2-RKT | ASB 2-RKWT



M12-Duo-Male - 2xM12-Female Str.

Actuator/sensor cordset, double-ended, M12 Duo male connector and two M12 female connectors with self-locking threaded joint.

– ASBA 2-RKT: with AND logic –

ASB 2-RKT | ASBA 2-RKT

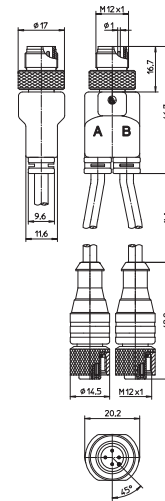

M12-Duo-Male - 2xM12-Female 90°

Actuator/sensor cordset, double-ended, M12 Duo male connector and two M12 female right angle connectors with self-locking threaded joint.

ASB 2-RKWT

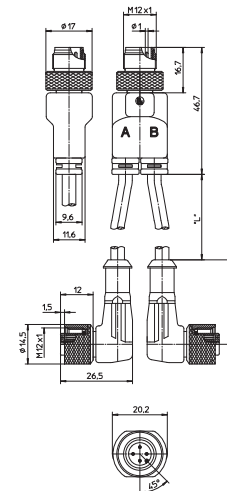

Pin Assignments

Wiring Diagrams

ASB 2 - RKT / ASB 2 - RKWT

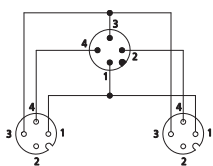

ASBA 2 - RKT

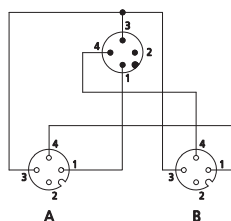



Be Certain with Belden

M12-Splitters, Single- and Double-Ended, IEC Color Code

ASB 2-RKT | ASBA 2-RKT | ASB 2-RKWT

Technical Data

Environmental

Degree of protection IP 67 / NEMA 6P
 Operating temperature range -25°C (-13°F) / +80°C (+176°F)

Mechanical

Housing / Molded body TPU
 Insert TPU
 Contact ASB: CuZn, pre-nickeled and 0.8 microns gold-plated
 RKT / RKWT: CuZn, pre-nickeled and 0.3 microns gold-plated
 Coupling nut CuZn, nickel-plated
 O-ring FKM (only RKT / RKWT)

Electrical

Nominal current at 40°C 4 A per cable / 4 A max. total
 Nominal voltage 60 V
 Rated voltage 63 V
 Test voltage 1.5 kV eff. / 60 s
 Insulation resistance > 10⁹ Ω
 Pollution degree 3

Cable Specifications

Cable No.	Outer Jacket	Gauge	Jacket Color	OD	Agency Approvals
224	PUR, halogen-free	3 x 0.34 mm ²	Black	.169" (4.3 mm)	UL: AWM 20327 / CSA: AWM I/II A/B
251	PUR, halogen-free welding spark proof	4 x 0.34 mm ²	Orange	.185" (4.7 mm)	UL: AWM 21198 / CSA: AWM I/II A/B

Part Number	Pins	Outer Jacket	Standard Cable Lengths	Characteristics
ASB 2-RKT 4-3-224/...M ASB 2-RKWT 4-3-224/...M	3	PUR, halogen-free	1 M / 1.5 M / 2 M	
ASB 2-RKT 4-3-251/...M ASB 2-RKWT 4-3-251/...M		PUR, halogen-free welding spark proof	1 M / 1.5 M / 2 M	
ASBA 2-RKT 4-3-224/...M	3	PUR, halogen-free	1 M / 1.5 M / 2 M	

M12 / M8-Splitters, Double-Ended, IEC Color Code

ASB 2-RKMWW/LED | ASB 2-RKWT/LED



M12-Duo-Male - 2xM8-Female 90° (LED)

Actuator/sensor cordset, double-ended, M12 Duo male connector and two M8 female right angle connectors with LED operation and function indicator, self-locking threaded joint.

ASB 2-RKMWW/LED

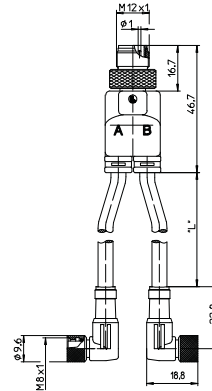

M12-Duo-Male - 2xM12-Female 90° (LED)

Actuator/sensor cordset, double-ended, M12 Duo male connector and two M12 female right angle connectors with LED operation and function indicator, self-locking threaded joint.

ASB 2-RKWT/LED

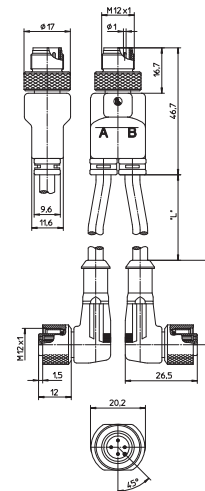

Pin Assignments

Wiring Diagrams

ASB 2 - RKMWW/LED

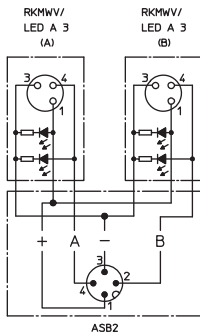

ASB 2 - RKWT/LED

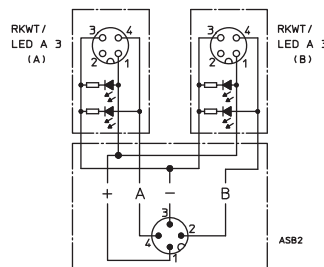



Be Certain with Belden

M12 / M8-Splitters, Double-Ended, IEC Color Code
 ASB 2-RKMWW/LED | ASB 2-RKWT/LED

Technical Data

Environmental

Degree of protection IP 67 / NEMA 6P
 Operating temperature range -25°C (-13°F) / +80°C (+176°F)

Mechanical

Housing / Molded body TPU
 Insert ASB / RKWT/LED: TPU
 RKMWW/LED: PA / TPU
 Contact ASB / RKWT/LED: CuZn, pre-nickeled and 0.8 microns gold-plated
 RKWT/LED: CuSn, pre-nickeled and 0.3 microns gold-plated
 Coupling nut CuZn, nickel-plated
 O-ring FKM (only RKMWW/LED / RKWT/LED)

Electrical

Nominal current at 40°C 4 A per cable / 4 A max. total
 Nominal voltage 10-30 V DC
 Rated voltage 32 V
 Insulation resistance > 10⁹ Ω
 Pollution degree 3

Cable Specifications

Cable No.	Outer Jacket	Gauge	Jacket Color	OD	Agency Approvals
224	PUR, halogen-free	3 x 0.34 mm ²	Black	.169" (4.3 mm)	UL: AWM 20327 / CSA: AWM I/II A/B

Part Number	Pins	Outer Jacket	Standard Cable Lengths	Characteristics
ASB 2-RKMWW/LED A 3-224/...M ASB 2-RKWT/LED A 3-224/...M	3	PUR, halogen-free	1 M / 1.5 M / 2 M	

M12-Splitters, Double-Ended, IEC Color Code

ASB 2-RST-RKT



M12-Duo-Male - 2xM12-Male/Female

Actuator/sensor cordset, double-ended, M12 Duo male connector with one M12 male connector and one M12 female connector, self-locking threaded joint.

ASB 2-RST-RKT

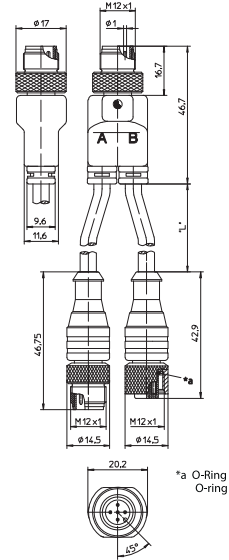

Pin Assignments

Wiring Diagrams

ASB 2 - RST-RKT

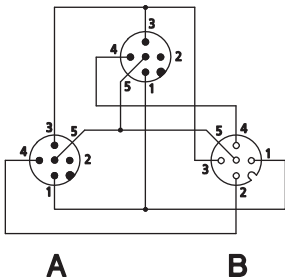

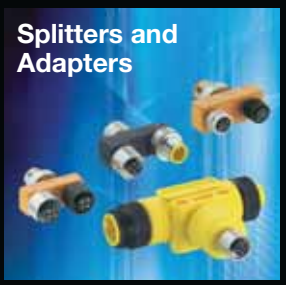

Be Certain with Belden

M12-Splitters, Double-Ended, IEC Color Code
ASB 2-RST-RKT

Technical Data

Environmental

Degree of protection IP 67 / NEMA 6P
Operating temperature range -25°C (-13°F) / +80°C (+176°F)

Mechanical

Housing / Molded body TPU
Insert TPI
Contact ASB / RST: CuZn, pre-nickeled and 0.8 microns gold-plated
RKT: CuZn, pre-nickeled and 0.3 microns gold-plated
Coupling nut CuZn, nickel-plated
O-ring FKM (only RKT)

Electrical

Nominal current at 40°C 4 A per cable / 4 A max. total
Nominal voltage 60 V
Rated voltage 63 V
Insulation resistance > 10⁹ Ω
Pollution degree 3

Cable Specifications

Cable No.	Outer Jacket	Gauge	Jacket Color	OD	Agency Approvals
226	PUR, halogen-free	3 x 0.50 mm ²	Black	4.6 mm	UL: AWM 21198 / CSA: AWM I/II A/B

Part Number	Pins	Outer Jacket	Standard Cable Lengths	Characteristics
ASB 2-RST 5-228/0.2-RKT 5-228/...M	5	PUR, halogen-free	1 M / 1.5 M / 2 M	

M12 / DIN Valve-Splitters, Double-Ended, IEC Color Code

ASB 2-VAD 1 A | ASB 2-VBD 1A



M12-Duo-Male - 2xDIN Valve

Actuator cordset, double-ended, M12 Duo male connector with self-locking threaded joint and two valve connectors according to

– DIN EN 175301-803, form A –

ASB 2-VAD 1A

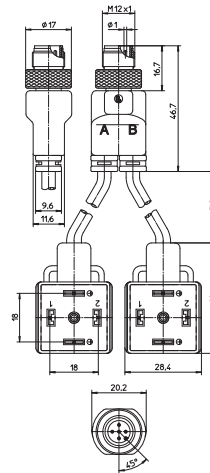

M12-Duo-Male - 2xDIN Valve

Actuator cordset, double-ended, M12 Duo male connector with self-locking threaded joint and two valve connectors according to

– DIN EN 175301-803, form B –

ASB 2-VBD 1A

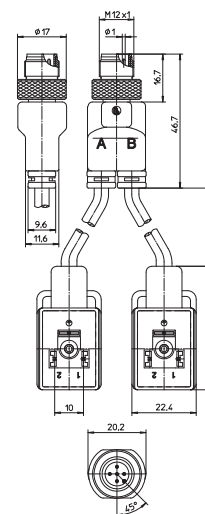

Pin Assignments

Wiring Diagrams

ASB 2 - VAD 1A

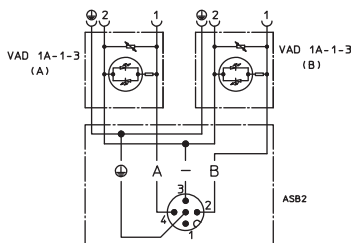

ASB 2 - VBD 1A

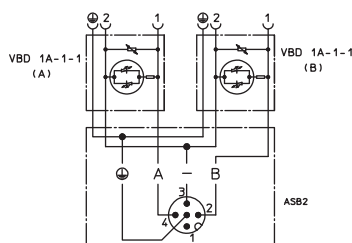



Be Certain with Belden

M12 / DIN Valve-Splitters, Double-Ended, IEC Color Code
 ASB 2-VAD 1 A | ASB 2-VBD 1A

Technical Data

Environmental

Degree of protection IP 67 / NEMA 6P
 Operating temperature range ASB: -25°C (-13°F) / +90°C (+194°F)
 VAD: -25°C (-13°F) / +80°C (+176°F)

Mechanical (ASB)

Housing / Molded body TPU, self-extinguishing
 Insert TPU, self-extinguishing
 Contact CuZn, pre-nickel and 0.8 microns gold-plated
 Coupling nut CuZn, nickel-plated

Mechanical (VAD / VBD)

Housing / Molded body TPU, self-extinguishing
 Insert PBT
 Contact CuZn, nickel plated and tin plated

Electrical



Nominal current at 40°C 4 A per cable / 4 A max. total
 Nominal voltage 24 V
 Rated voltage 32 V
 Insulation resistance > 10⁹ Ω
 Pollution degree 3

Varistor data (VAD / VBD)

Nominal voltage 47 V at 0.1 mA
 typ. limiting voltage 110 V at 5 A
 max. pulse energy 0.9 Ws
 (standard impulse 10/1000us)
 max. continuous power loss 0.01 W

Cable Specifications

Cable No.	Outer Jacket	Gauge	Jacket Color	OD	Agency Approvals
226	PUR, halogen-free	3 x 0.50 mm ²	Black	4.6 mm	UL: AWM 21198 / CSA: AWM I/II A/B

Part Number	Pins	Outer Jacket	Standard Cable Lengths	Characteristics
ASB 2-VAD 1A-1-3-226/...M	5	PUR, halogen-free	1 M / 1.5 M / 2 M	 

M12 / DIN Valve-Splitters, Double-Ended, IEC Color Code

ASB 2-VB 1 A | ASB 2-VC 1A



M12-Duo-Male - 2xDIN Valve

Actuator cordset, double-ended, M12 Duo male connector with self-locking threaded joint and two valve connectors according to

– DIN EN 175301-803, form B –

ASB 2-VB 1 A

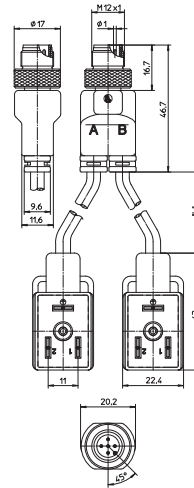

M12-Duo-Male - 2xDIN Valve

Actuator cordset, double-ended, M12 Duo male connector with self-locking threaded joint and two valve connectors according to

– DIN EN 175301-803, form C –

ASB 2-VC 1A

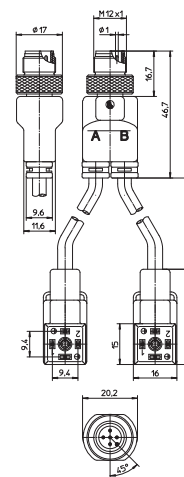

Pin Assignments

Wiring Diagrams

ASB 2 - VB 1A

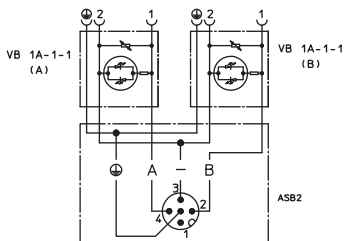

ASB 2 - VC 1A

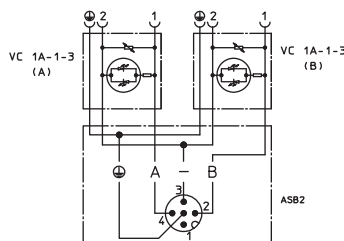

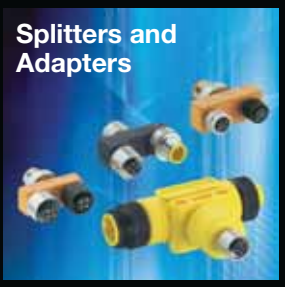

Be Certain with Belden

M12 / DIN Valve-Splitters, Double-Ended, IEC Color Code
 ASB 2-VB 1 A | ASB 2-VC 1A

Technical Data

Environmental

Degree of protection IP 67 / NEMA 6P
 Operating temperature range ASB: -25°C (-13°F) / +90°C (+194°F)
 VAD: -25°C (-13°F) / +80°C (+176°F)

Mechanical (ASB)

Housing / Molded body TPU, self-extinguishing
 Insert TPU, self-extinguishing
 Contact CuZn, pre-nickel and 0.8 microns gold-plated
 Coupling nut CuZn, nickel-plated

Mechanical (VAD / VBD)

Housing / Molded body TPU, self-extinguishing
 Insert PBT
 Contact CuZn, nickel plated and tin plated

Electrical



Nominal current at 40°C 4 A per cable / 4 A max. total
 Nominal voltage 24 V
 Rated voltage 32 V
 Insulation resistance > 10⁹ Ω
 Pollution degree 3

Varistor data (VAD / VBD)

Nominal voltage 47 V at 0.1 mA
 typ. limiting voltage 110 V at 5 A
 max. pulse energy 0.9 Ws
 (standard impulse 10/1000us)
 max. continuous power loss 0.01 W

Cable Specifications

Cable No.	Outer Jacket	Gauge	Jacket Color	OD	Agency Approvals
226	PUR, halogen-free	3 x 0.50 mm ²	Black	4.6 mm	UL: AWM 21198 / CSA: AWM I/II A/B

Part Number	Pins	Outer Jacket	Standard Cable Lengths	Characteristics
ASB 2-VB 1A-1-1-226/... M ASB 2-VC 1A-1-3-226/... M	5	PUR, halogen-free	1 M / 1.5 M / 2 M	 

M12-Splitters, Single- and Double-Ended, IEC Color Code

ASB 2 | ASB 2-RKT | ASB 2-RKWT



M12-Duo-Male to Open Leads

Splitter, single-ended, M12-duo, male straight with self-locking threaded joint and two open leads.

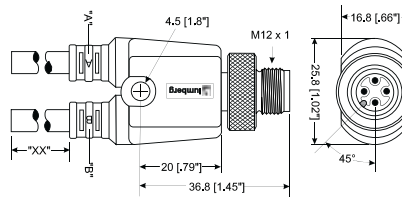

M12-Duo-Male to 2xM12 Female Str.

Splitter, double-ended, M12-duo, male straight to two M12, female straight connectors with self-locking threaded joint.

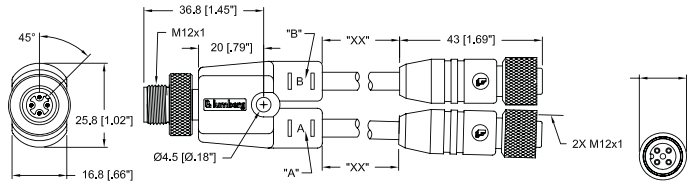

M12-Duo-Male to 2xM12 Female 90°

Splitter, double-ended, M12-duo, male straight to two M12, female 90° connectors with self-locking threaded joint.

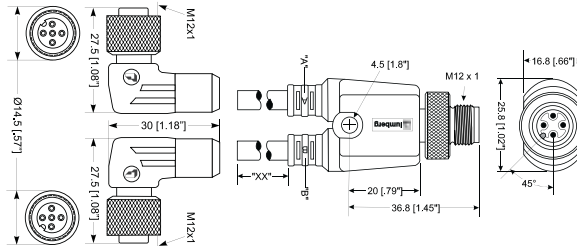

Pin Assignments

Wiring Diagram

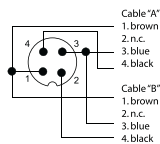
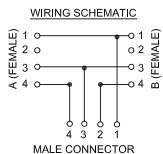



Be Certain with Belden

M12-Splitters, Single- and Double-Ended, IEC Color Code ASB 2 | ASB 2-RKT | ASB 2-RKWT

Technical Data

Environmental

Degree of protection	IP 67 / NEMA 6P
Operating temperature range	TPE: -40°C (-40°F) / +90°C (+194°F) PVC: -40°C (-40°F) / +90°C (+194°F) PUR: -40°C (-40°F) / +80°C (+176°F)

Mechanical (RST)





















Housing / Molded body	TPU, yellow
Insert	TPU, black (RKT / RKWT) TPU, yellow (ASB 2)
Contact	CuZn, gold plated
Coupling nut	CuZn, nickel-plated
O-ring	FKM

Electrical

Contact resistance	≤ 5 mΩ
Current rating	4 A
Voltage rating	250 V

Cable Specifications

Cable No.	Outer Jacket	Gauge	Jacket Color	OD	Agency Approvals
637	TPE	18AWG	Yellow	.280" (7.1 mm)	UL: AWM 20327 / CSA: AWM I/II A/B
643	TPE	22AWG	Yellow	.246" (6.2 mm)	UL: PLTC / CSA: AWM I/II A/B
632	PVC	22AWG	Yellow	.190" (4.8 mm)	UL: AWM 2661 / CSA: AWM I/II A/B
645	PUR	18AWG	Yellow	.220" (5.6 mm)	UL: AWM 20233 / CSA: AWM I/II A/B

Part Number		Pins	Outer Jacket	Standard Cable Lengths	Characteristics
ASB 2 4-3-632/...M		3	PVC	0.3 M / 0.6 M / 1 M / 1.5 M / 2 M / 5 M	  
	ASB 2-RKT 4-3-632/...M ASB 2-RKWT 4-3-632/...M		PVC	0.3 M / 0.6 M / 1 M / 1.5 M / 2 M / 5 M	  
	ASB 2-RKT 4-3-637/...M ASB 2-RKWT 4-3-637/...M		TPE	0.3 M / 0.6 M / 1 M / 1.5 M / 2 M / 5 M	     
	ASB 2-RKT 4-3-643/...M		TPE	0.3 M / 0.6 M / 1 M / 1.5 M / 2 M / 5 M	    
	ASB 2-RKT 4-3-645/...M ASB 2-RKWT 4-3-645/...M		PUR	0.3 M / 0.6 M / 1 M / 1.5 M / 2 M / 5 M	  

M12-Splitters, Double-Ended, IEC Color Code

AKB 2-RST



M12-Duo-Female to 2xM12 Male Str.

Splitter, double-ended, M12-duo, female straight to two M12, male straight connectors with self-locking threaded joint.

AKB 2-RST

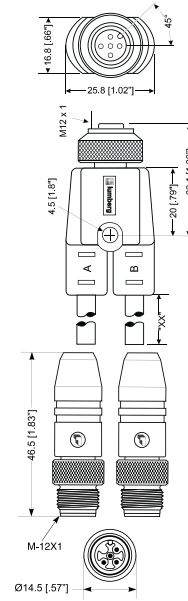

Pin Assignments

Wiring Diagram

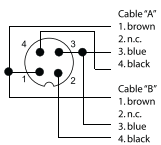

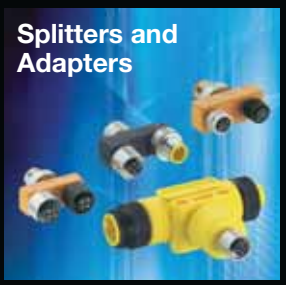

Be Certain with Belden

M12-Splitters, Single- and Double-Ended, IEC Color Code
AKB 2-RST

Technical Data

Environmental

Degree of protection IP 67 / NEMA 6P
Operating temperature range -15°C (+5°F) / +90°C (+194°F)

Mechanical (RST)

Housing / Molded body TPU, yellow
Insert TPU, black (AKB 2)
TPU, yellow (RST)
Contact CuZn, gold plated
Coupling nut CuZn, nickel-plated
O-ring FKM



Electrical

Contact resistance ≤ 5 mΩ
Current rating 4 A
Voltage rating 250 V

Cable Specifications

Cable No.	Outer Jacket	Gauge	Jacket Color	OD	Agency Approvals
602	PUR	18AWG	Yellow	.230" (5.8 mm)	UL: AWM 20233 / CSA: AWM I/II A/B

Splitters and Adapters

Part Number	Pins	Outer Jacket	Standard Cable Lengths	Characteristics
AKB 2-RST 3-602/...M	3	PUR	0.3 M / 0.6 M / 1 M / 1.5 M / 2 M / 5 M	 

M12-Splitters/T-Connectors

ZV 2



M12 Male / Female

Splitter/T-connector, double female (2 port distribution box) with self-locking threaded joint, 3-poles with molded cable.

ZV 2

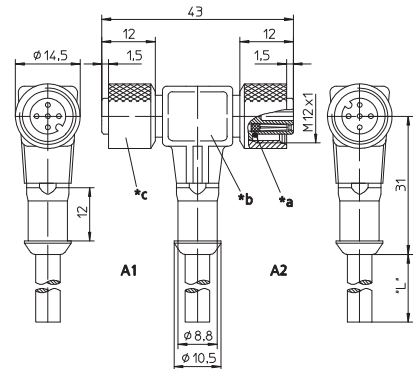

*a O-Ring
*b hose mounting
*c coupling nut black

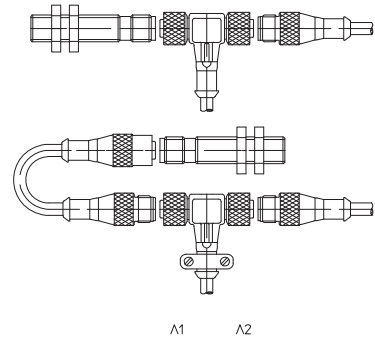

Pin Assignments

M12 Female

3 poles



- 1 = brown
- 2 = n.c.
- 3 = blue
- 4 = black (A1) / white (A2)

Wiring Diagram

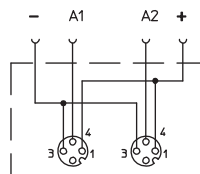

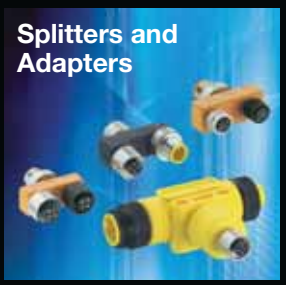

Be Certain with Belden

M12-Splitters/T-Connectors
ZV 2

Technical Data

Environmental

Degree of protection IP 67 / NEMA 6P
Operating temperature range -25°C (-13°F) / +80°C (+176°F)

Mechanical

Housing / Molded body TPU, self-extinguishing
Insert TPU, self-extinguishing
Contact CuZn, pre-nickel and 0.8 microns gold-plated
Coupling nut CuZn, nickel-plated
O-ring FKM

Electrical

Contact resistance ≤ 5 mΩ
Nominal current at 40°C 4 A
Nominal voltage 60 V
Rated voltage 63 V
Test voltage 2.0 kV eff. / 60 s
Insulation resistance > 10⁹ Ω
Pollution degree 3

Cable Specifications

Cable No.	Outer Jacket	Gauge	Jacket Color	OD	Agency Approvals
225	PUR, halogen-free	4 x 0.34 mm ²	Black	.185" (4.7 mm)	UL: AWM 20233 / CSA: AWM I/II A/B

Splitters and Adapters

Part Number	Pins	Outer Jacket	Standard Cable Lengths	Characteristics
ZV 2 4-3-225/...M	3	PUR, halogen-free	2 M / 5 M / 10 M	

M12-Splitters/T-Connectors

ASBS 2 M8 | ASBS 2 M12 | ASBSA 2 M12



M12 Male to 2xM8 Female

Splitter/T-connector, with two M8 miniature female connectors, 3 poles, with self-locking threaded joint.

ASBS 2 M8

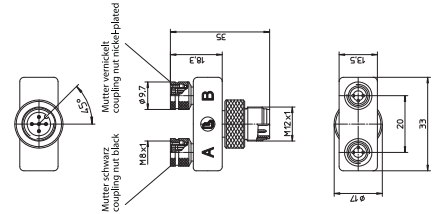

M12 Male to 2xM12 Female

Splitter/T-connector with two M12 female connectors, with self-locking threaded joint.

– ASBS 2 M12-5 1-1: wired through 1 to 1 –

M12 Male to 2xM12 Female

Splitter/T-connector with two M12 female connectors, with self-locking threaded joint.

– ASBSA 2 M12-3: with AND circuit –

ASBS 2 M12

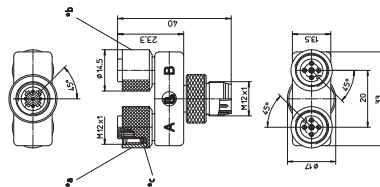

*a coupling nut black
*b coupling nut nickel-plated

ASBSA 2 M12

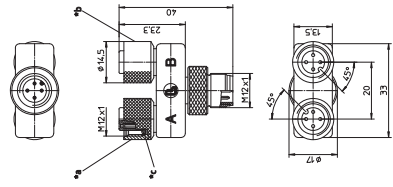

*c O-ring

Pin Assignments

Face Views

ASBS 2 M8

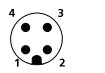

A



B



ASBSA 2 M12-3

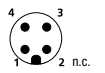

A



B



ASBS 2 M12-5S

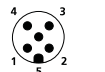

A



B



ASBS 2 M12-5

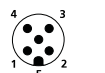

A



B



Wiring Diagrams

ASBS 2 M8

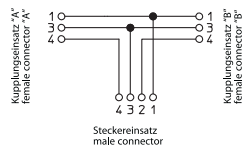

ASBSA 2 M12-3

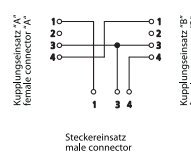

ASBS 2 M12-5S

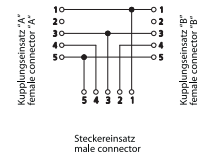

ASBS 2 M12-5

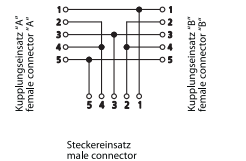

ASBS 2 M12-5 1-1

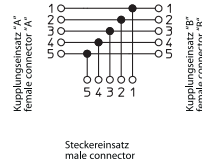

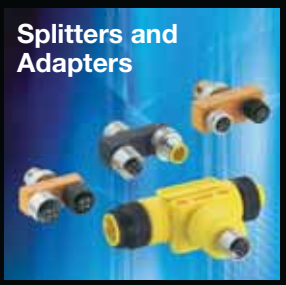

Be Certain with Belden

M12-Splitters/T-Connectors

ASBS 2 M8 | ASBS 2 M12 | ASBSA 2 M12

Technical Data

Environmental

Degree of protection IP 67 / NEMA 6P
 Operating temperature range -25°C (-13°F) / +90°C (+194°F)

Mechanical

Housing / Molded body TPU, self-extinguishing
 Insert Female connectors:
 M8: TPU, self-extinguishing
 M12: PA GF, self-extinguishing
 Male connector:
 TPU, self-extinguishing
 Contact CuZn, pre-nickel and 0.8 microns gold-plated
 Coupling nut CuZn, nickel-plated
 O-ring FKM

Electrical

Contact resistance ≤ 5 mΩ
 Nominal current at 40°C 4 A per outlet / 4 A max. total
 Nominal voltage 60 V
 Rated voltage 63 V
 Test voltage M8: 0.8 kV eff. / 60 s
 M12: 1.5 kV eff. / 60 s
 ASBSA: 2.0 kV eff. / 60 s
 Insulation resistance > 10⁹ Ω
 Pollution degree 3

Part Number	Pins	Characteristics
ASBS 2 M8	3	
ASBSA 2 M12-3		
ASBS 2 M12-5S	5	
ASBS 2 M12-5		
ASBS 2 M12-5 1-1		

M12-Splitters/T-Connectors

ASBS 2 M12-S2326 | ASBS 2 M12-S2325



M12 Male to 2xM12 Female

Splitter/T-connector, two way, 4-poles with one M12 male connector and two M12 female connectors.

ASBS 2 M12-S2326

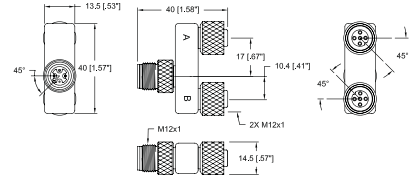

M12 Male to 2xM12 Female

Splitter/T-connector, two way, 5-poles with one M12 male connector and two M12 female connectors.

ASBS 2 M12-S2325

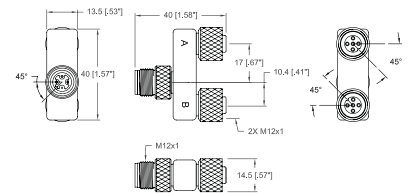

Pin Assignments

Face Views

ASBS 2 M12-S2326

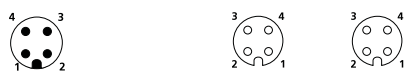

ASBS 2 M12-S2325

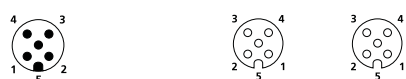

Wiring Diagrams

ASBS 2 M12-S2326

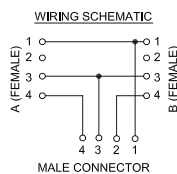

ASBS 2 M12-S2325

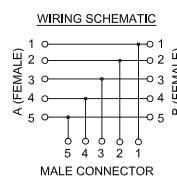

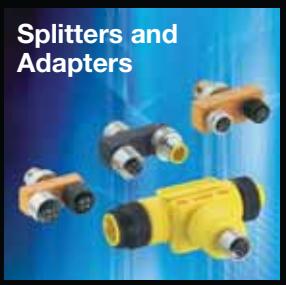

Be Certain with Belden

M12-Splitters/T-Connectors

ASBS 2 M12-S2326 | ASBS 2 M12-S2325

Technical Data

Environmental

Degree of protection IP 67 / NEMA 6P
 Operating temperature range -15°C (+5°F) / +90°C (+194°F)

Mechanical

Molded body PUR, black
 Insert PUR, black
 Contact Brass, gold over nickel plated
 Coupling nut Brass, nickel-plated
 O-ring FKM

Electrical

Contact resistance ≤ 5 mΩ
 Current rating 4 A
 Voltage rating 250 V

Splitters and Adapters

Part Number	Pins	Characteristics
ASBS 2 M12-S2326	4	 
ASBS 2 M12-S2325	5	 

M12-Splitters/T-Connectors

ASBS 2 M8-90 | ASBS 2 M12...-90



M12 Male to 2xM8 Female

ASBS 2 M8-90

Splitter/T-connector, with two M8 miniature female connectors, 3 poles, 90° with self-locking threaded joint.

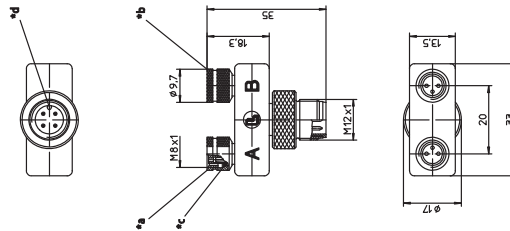

- *a coupling nut black
- *b coupling nut nickel-plated
- *c O-Ring
- *d coding 90°



M12 Male to 2xM12 Female

ASBS 2 M12...-90

Splitter/T-connector with two M12 female connectors, 4 and 5 poles, 90°-version, with self-locking threaded joint.

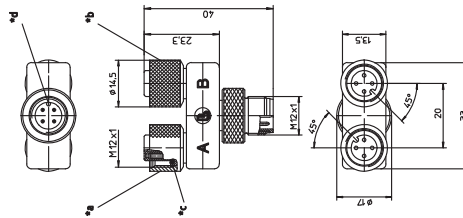

- *a coupling nut black
- *b coupling nut nickel-plated
- *c O-Ring
- *d coding 90°

Pin Assignments

Face Views

ASBS 2 M8-90



A



B



ASBS 2 M12-4S-90



A



B



ASBS 2 M12-5-90



A



B



Wiring Diagrams

ASBS 2 M8-90

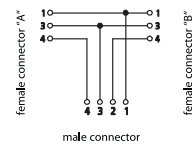

ASBS 2 M12-4S-90

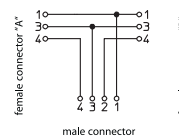

ASBS 2 M12-5-90

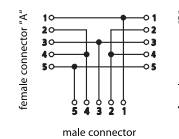

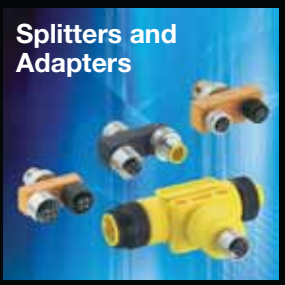

Be Certain with Belden

M12-Splitters/T-Connectors

ASBS 2 M8-90 | ASBS 2 M12...-90

Technical Data

Environmental



Degree of protection IP 67 / NEMA 6P
 Operating temperature range -25°C (-13°F) / +90°C (+194°F)

Mechanical

Housing / Molded body TPU, self-extinguishing
 Insert Female connectors:
 M8: TPU, self-extinguishing
 M12: PA GF, self-extinguishing
 Male connector:
 TPU, self-extinguishing
 Contact CuZn, pre-nickel and 0.8 microns gold-plated
 Coupling nut CuZn, nickel-plated
 O-ring FKM

Electrical

Contact resistance $\leq 5 \text{ m}\Omega$
 Nominal current at 40°C 2 A per outlet / 4 A max. total
 Nominal voltage M8: 60 V
 M12: 4 poles 240 V
 M12: 5 poles 60 V
 Rated voltage M8: 63 V
 M12: 4 poles 250 V
 M12: 5 poles 63 V
 Test voltage M8: 1.0 kV eff. / 60 s
 M12: 4 poles 2.0 kV eff. / 60 s
 M12: 5 poles 1.0 kV eff. / 60 s
 Insulation resistance $> 10^9 \Omega$
 Pollution degree 3

Part Number	Pins	Characteristics
ASBS 2 M8-90	3	
ASBS 2 M12-4S-90	4	
ASBS 2 M12-5-90	5	

M12-Splitters/T-Connectors

FASBS 2 M12



M12 Male to 2xM12 Female

Splitter/T-connector, with one M12 male and two M12 female connectors, 5-poles. Includes mounting hole for ease of installation.

FASBS 2 M12

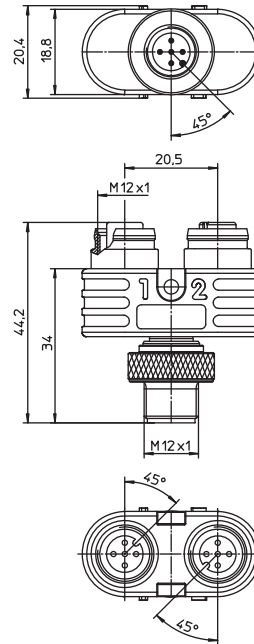

Pin Assignments

Face Views

5-poles



A



B



Wiring Diagrams

FASBS 2 M12

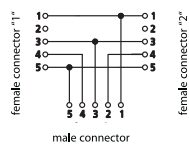



Be Certain with Belden

M12-Splitters/T-Connectors

FASBS 2 M12

Technical Data

Environmental

Degree of protection IP 67 / NEMA 6P
 Operating temperature range -25°C (-13°F) / +90°C (+194°F)

Mechanical

Housing / Molded body TPU, self-extinguishing
 Insert TPU, self-extinguishing
 Contact CuZn, pre-nickeled and 0.3 microns gold-plated
 Coupling nut CuZn, nickel-plated
 O-ring FKM

Electrical

Contact resistance $\leq 5 \text{ m}\Omega$
 Nominal current at 40°C 4 A
 Nominal voltage 60 V
 Rated voltage 63 V
 Test voltage 1.5 kV eff. / 60 s
 Insulation resistance $> 10^9 \Omega$
 Pollution degree 3

Part Number	Pins	Characteristics
FASBS 2 M12-5S	5	

M12-Splitters/T-Connectors

0906 UTP 101



1 x M12 Male and 2 x M12 Female

Splitter/T-connector, with one M12 male and two M12 female connectors, 5-poles.
– especially suitable for DeviceNet and CANopen modules with M12 bus connection –

0906 UTP 101

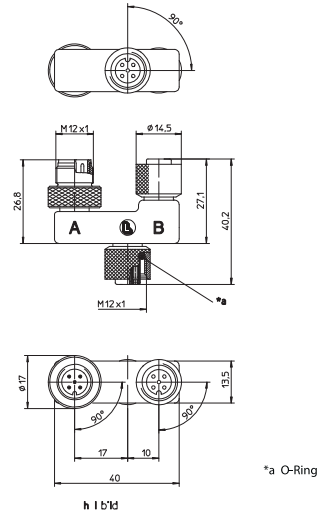

Pin Assignments

Face Views

M12 - 5-poles

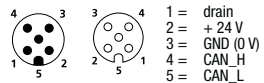

Wiring Diagrams

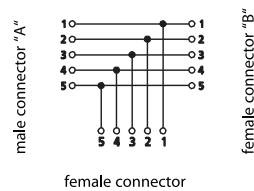



Be Certain with Belden

M12-Splitters/T-Connectors

0906 UTP 101

Technical Data

Environmental



Degree of protection IP 67 / NEMA 6P
Operating temperature range -25°C (-13°F) / +90°C (+194°F)

Mechanical

Housing / Molded body TPU
Insert TPU
Contact CuZn, pre-nickeled and gold-plated
Coupling nut CuZn, brass, nickeled
O-ring FKM

Electrical

Contact resistance $\leq 5 \text{ m}\Omega$
Nominal current at 40°C 4 A per outlet / 4 A max. total
Nominal voltage 60 V
Test voltage 1.5 kV eff. / 60 s
Insulation resistance $> 10^9 \Omega$
Pollution degree 3

Part Number	Pins	Characteristics
0906 UTP 101	5	 

7/8"-Splitters/T-Connectors

0906 UTP 301



1 x 7/8" male and 2 x 7/8" Female

Splitter/T-connector, with one 7/8" female, one 7/8" male, and one 7/8" female connectors, 5-poles.

– especially suitable for DeviceNet modules with 7/8" bus connection –

0906 UTP 301

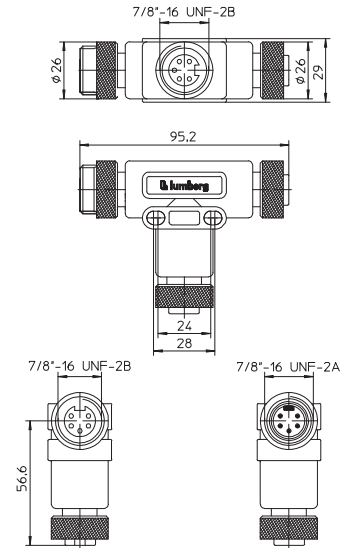

Pin Assignments

Face Views

7/8" - 5 poles

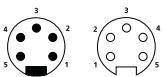

- 1 = drain
- 2 = + 24 V
- 3 = GND (0 V)
- 4 = CAN_H
- 5 = CAN_L

Wiring Diagrams

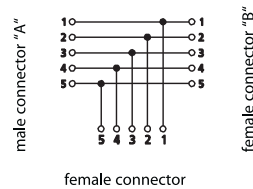

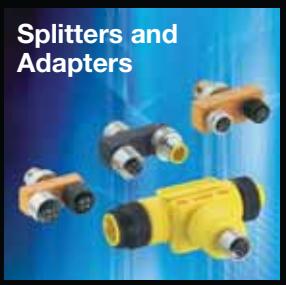

Be Certain with Belden

7/8"-Splitters/T-Connectors

0906 UTP 301

Technical Data

Environmental

Degree of protection IP 67 / NEMA 6P
 Operating temperature range -25°C (-13°F) / +90°C (+194°F)

Mechanical

Housing / Molded body TPU
 Insert TPU
 Contact CuZn, pre-nickel and 0.8 microns gold-plated
 Coupling nut Aluminum, black anodized

Electrical

Contact resistance ≤ 5 mΩ
 Nominal current at 20°C Trunk: 8 A
 Drop: 4 A
 Nominal voltage 300 V
 Insulation resistance > 10⁹ Ω
 Pollution degree 3

Splitters and Adapters

Part Number	Pins	Characteristics
0906 UTP 301	5	

7/8"-Splitters/T-Connectors

0906 UTP 302



**1 x M12 Female to 1 x 7/8" Male to
1 x 7/8" Female**

Splitter/T-connector, with one M12 female, one 7/8" male and one 7/8" female connectors, 5-poles.

– especially suitable for DeviceNet and CANopen modules with M12 bus connection –

0906 UTP 302

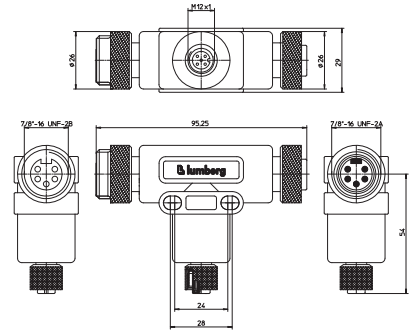

Pin Assignments

Face Views

M12 - 5 poles

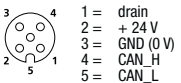

7/8" - 5 poles

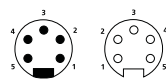

1 = drain
2 = + 24 V
3 = GND (0 V)
4 = CAN_H
5 = CAN_L

Wiring Diagram

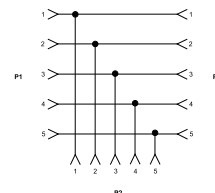

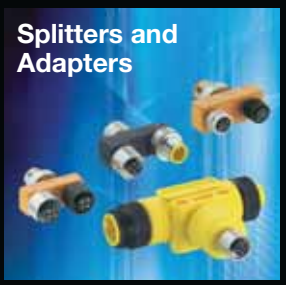

Be Certain with Belden

7/8"-Splitters/T-Connectors

0906 UTP 302

Technical Data

Environmental

Degree of protection IP 67 / NEMA 6P
 Operating temperature range -40°C (-40°F) / +90°C (+194°F)



Mechanical

Housing / Molded body TPU
 Insert TPU
 Contact CuZn, pre-nickel and gold-plated acc. to DeviceNet specification
 Coupling nut Aluminum, brass, nicked (7/8")
 CuZn, brass, nicked (M12)

Electrical

Nominal current Trunk: 8 A
 Drop: 4 A
 Nominal voltage 30 V AC / 36 V DC

Splitters and Adapters

Part Number	Pins	Characteristics
0906 UTP 302	5	 

7/8"-Splitters/T-Connectors

0906 UTP 303



2 x 7/8" Female to 1 x 7/8" Male

Splitter/T-connector, with one 7/8" female, one 7/8" male and one 7/8" female connectors, 3-poles.

– especially suitable for DeviceNet and CANopen modules –

0906 UTP 303

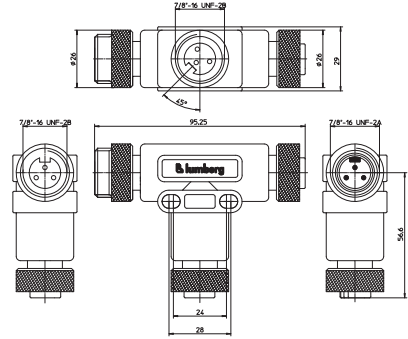

Pin Assignments

Face Views

7/8" - 3 poles

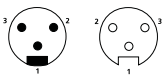

- 1 = earth
- 2 = + 24 V
- 3 = GND (0 V)

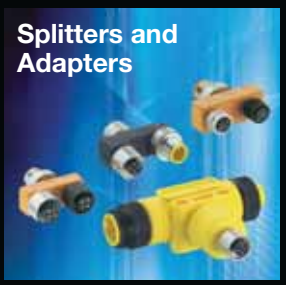

Be Certain with Belden

7/8"-Splitters/T-Connectors

0906 UTP 303

Technical Data

Environmental

Degree of protection IP 67 / NEMA 6P
 Operating temperature range -40°C (-40°F) / +90°C (+194°F)

Mechanical

Housing / Molded body TPU
 Insert TPU
 Contact CuZn, gold over silver plating
 Coupling nut Aluminum, black anodized

Electrical

Nominal current 8 A
 Nominal voltage 600 V

Splitters and Adapters

Part Number	Pins	Characteristics
0906 UTP 303	3	 

7/8"-Splitters/T-Connectors

0906 UTP 312



7/8" Female to 1x7/8" Male and Female

Splitter/T-connector, with one 7/8" female, one 7/8" male and one 7/8" female connectors, 4-poles.

– especially suitable for DeviceNet and CANopen modules –

0906 UTP 301

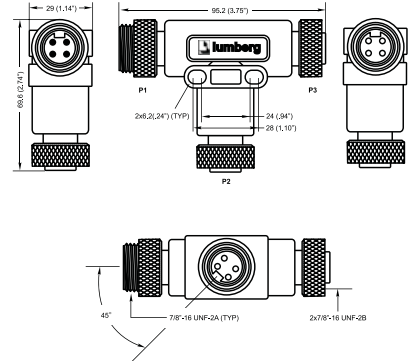

Pin Assignments

Face Views

7/8 - 4 poles

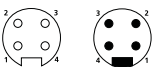

P 2/3 P 1

Wiring Diagram

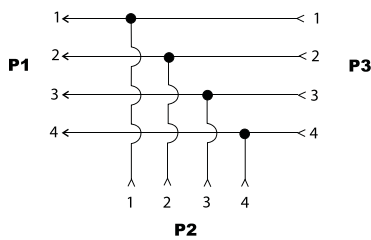

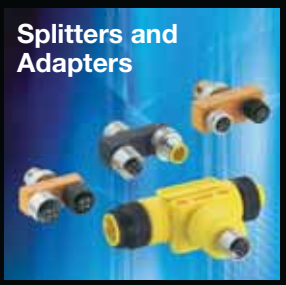

Be Certain with Belden

7/8"-Splitters/T-Connectors

0906 UTP 312

Technical Data

Environmental

Degree of protection IP 67 / NEMA 6P
 Operating temperature range -40°C (-40°F) / +90°C (+194°F)

Mechanical

Housing / Molded body TPU, yellow
 Insert TPU, yellow
 Contact CuZn, pre-nickel and gold-plated acc. to DeviceNet specification
 Coupling nut Aluminum, black anodized

Electrical

Nominal current 8 A
 Nominal voltage 600 V

Splitters and Adapters

Part Number	Pins	Characteristics
-------------	------	-----------------

0906 UTP 312	4	
--------------	---	--

M23-Splitters/T-Connectors

0906 UTP 201 | 0906 UTP 202



M23 Male to 2xM23 Female

Splitter/T-connector, with one M23 male and two M23 female connectors, 6-poles.

– especially suitable for Profibus and Interbus modules –

0906 UTP 201

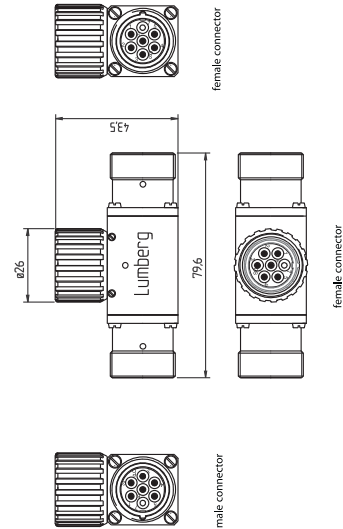

M23 male to 2xM23 Female

Splitter/T-connector, with one M23 male, one and two M23 female connectors, 12-poles.

– especially suitable for Profibus modules with M23 bus connection for separate feeding of power supply (system/sensor system) and Profibus signals –

0906 UTP 202

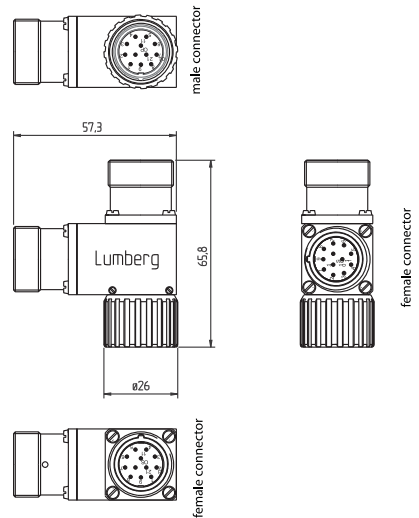

Pin Assignments

Face Views

M23 - 6 poles

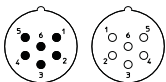

- 1 = earth
- 2 = + 24 V (1)
- 3 = GND (0 V) (1)
- 4 = + 24 V (2)
- 5 = GND (0 V) (2)
- 6 = n.c.

M23 - 12 poles

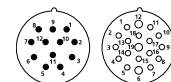

- 1 = n.c.
- 2 = Signal A
- 3 = n.c.
- 4 = Signal B
- 5 = n.c.
- 6 = n.c.
- 7 = + 24 V
- 8 = GND (0 V)
- 9 = earth
- 10 = n.c.
- 11 = n.c.
- 12 = n.c.

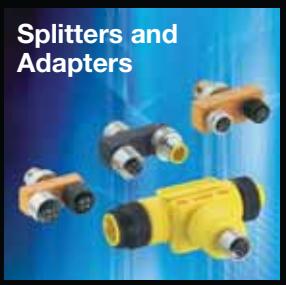

Be Certain with Belden

M23-Splitters/T-Connectors

0906 UTP 201 | 0906 UTP 202

Technical Data

Environmental

Degree of protection IP 67 / NEMA 6P
 Operating temperature range -40°C (-40°F) / +125°C (+257°F)

Mechanical

Housing Copper-Zinc alloy (CuZn),
 die casting part of Zinc (GD-Zn)
 Housing surface nickel-plated

Electrical

Nominal current UTP 201: 20 A
 UTP 202: 8 A
 Nominal voltage 50 V DC
 Pollution degree 3

Splitters and Adapters

Part Number	Pins	Characteristics
0906 UTP 201	6	
0906 UTP 202	12	

M23-Splitters/T-Connectors

0906 UTP 203 | 0906 UTP 204



M23 Male to 2xM23 Female

Splitter/T-connector for power supply with M23 male/female connector, 6 poles.

– especially suitable for the e2c 67 system to drag the power supply –

0906 UTP 203

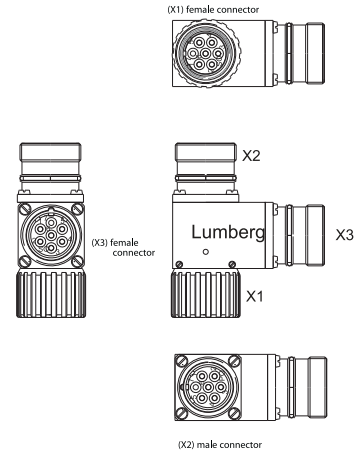

M23 Female to 2xM23 Male

Splitter/T-connector for separate feeding of the power supply at installation remote bus modules with M23 male/female connector, 9 poles.

– especially suitable for Interbus installation remote bus modules–

0906 UTP 204

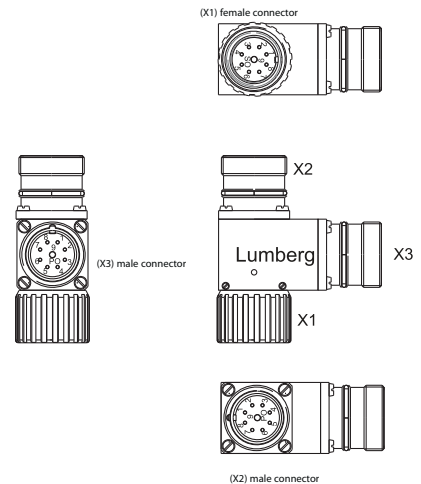

Pin Assignments

Face Views

M23 - 6 poles

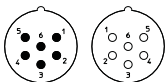

- 1 = earth
- 2 = + 24 V¹
- 3 = GND (0 V)¹
- 4 = + 24 V²
- 5 = GND (0 V)²
- 6 = n.c.
- housing = n.c.

M23 - 9 poles

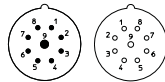

- 1 = DQ
- 2 = DO
- 3 = DI
- 4 = DI
- 5 = COM
- 6 = earth
- 7 = + 24 V
- 8 = GND (0 V)
- 9 = n.c.
- housing = n.c.

¹ = Profibus: actuator 1
Interbus: actuator

² = Profibus: actuator 2
Interbus: system

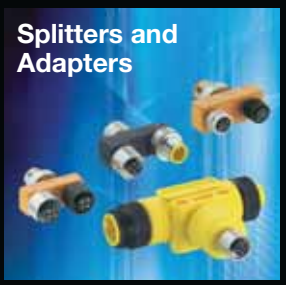

Be Certain with Belden

M23-Splitters/T-Connectors

0906 UTP 203 | 0906 UTP 204

Technical Data

Environmental

Degree of protection IP 67 / NEMA 6P
 Operating temperature range -40°C (-40°F) / +125°C (+257°F)



Mechanical

Housing Copper-Zinc alloy (CuZn),
 die casting part of Zinc (GD-Zn)
 Housing surface nickel-plated

Electrical

Nominal current UTP 203: 20 A
 UTP 204: 8 x 8 A / 1 x 20 A
 Nominal voltage 50 V DC
 Pollution degree 3

Splitters and Adapters

Part Number	Pins	Characteristics
0906 UTP 203	6	 
0906 UTP 204	9	  

DIN Valve Adapters

VAD M12 1A-VAD 1A-1-3



DIN Valve Adapter with M12 Connection

Double solenoid valve adaptor (valve adaptor with integrated M12 male receptacle connector), according to DIN EN175301-803, form A, with LED function indicator and varistor for voltage protection, connected protective earth.

VAD M12 1A-VAD 1A-1-3

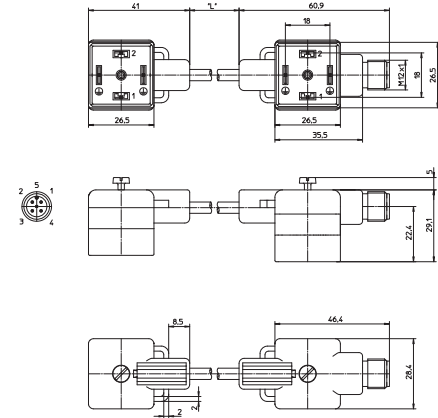

Pin Assignments

Face Views

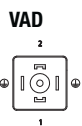

- 1 = brown
- 2 = blue
- 3 = green/yellow

Wiring Diagram

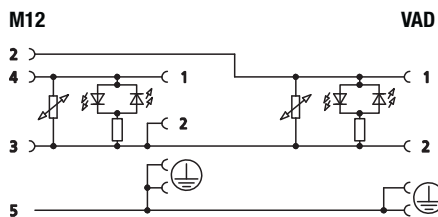



Be Certain with Belden

DIN Valve Adapters

VAD M12 1A-VAD 1A-1-3

Technical Data

Environmental

Degree of protection IP 67 / NEMA 6P
 Operating temperature range -25°C (-13°F) / +80°C (+176°F)

Mechanical

Housing / Molded body TPU, self-extinguishing
 Insert PBT
 Contact CuZn, nickel-plated and tin-plated

Electrical



Contact resistance $\leq 5 \text{ m}\Omega$
 Nominal current at 40°C 4 A
 Nominal voltage 24 V
 Rated voltage 32 V
 Insulation resistance $> 10^9 \Omega$
 Pollution degree 3

Varistor data

Nominal voltage 47 V at 0.1 mA
 typ. limiting voltage 110 V at 5 A
 max. pulse energy (standard impulse 10/1000us) 0.9 Ws
 max. continuous power loss 0.01 W

Accessories (incl.)

Attachable label
 Screw (fitted)

Part Number	Pins	Outer Jacket	Characteristics
VAD M12 1A-VAD 1A-1-3-226/0,4 M	2 + ⊕	PUR, halogen-free	
VAD M12 1A-VAD 1A-1-3-241/0,4 M	2 + ⊕	PUR, halogen-free / welding spark proof	

DIN Valve Adapters

VAD 3C-4-1 | VAD 1A...M12



DIN Valve Adapter with M12 Connection

Connector for pressure switches according to DIN EN 175301-803, form A, with LED operation and function indicator, with M12 male receptacle connect.

VAD 3C-4-1

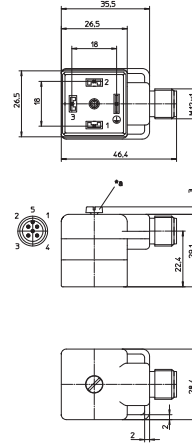

*a M3 screw



DIN Valve Adapter with M12 Connection

Valve adaptor according to DIN EN 175301-803, form A, with LED function indicator, varistor voltage protection, connected protective earth, with M12 male receptacle connector.

VAD 1A...M12

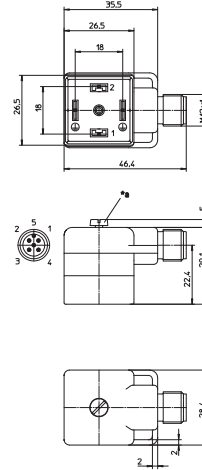

*a M3 screw

Pin Assignments

Face Views

VAD 3C-4-1-M12-5

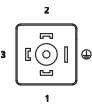

VAD 1A-1-3-M12-5

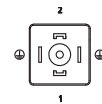

Wiring Diagram

VAD 3C-4-1-M12-5

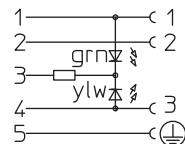

VAD 1A-1-3-M12-5

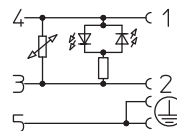



Be Certain with Belden

DIN Valve Adapters

VAD 3C-4-1 | VAD 1A...M12

Technical Data

Environmental

Degree of protection IP 67 / NEMA 6P
 Operating temperature range -25°C (-13°F) / +80°C (+176°F)

Mechanical

Housing / Molded body VAD: TPU, self-extinguishing
 M12: CuZn, nickel-plated
 Insert VAD: PBT
 M12: PA
 Contact VAD: CuZn, pre-nickeled and tin-plated
 M12: CuZn, pre-nickeled and 0.8 microns gold-plated

Electrical

Contact resistance $\leq 5 \text{ m}\Omega$
 Nominal current at 40°C 4 A
 Nominal voltage VAD 1A: 24 V
 VAD 3C: 24 V DC
 Rated voltage 32 V
 Insulation resistance $> 10^9 \Omega$
 Pollution degree 3

Varistor data

Nominal voltage 47 V at 0.1 mA
 typ. limiting voltage 110 V at 5 A
 max. pulse energy (standard impulse 10/1000us) 0.9 Ws
 max. continuous power loss 0.01 W

Accessories (incl.)

Attachable label
 Screw (fitted)

Part Number	Pins	Characteristics
VAD 3C-4-1-M12-5	2 + ⊕	 
VAD 1A-1-3-M12-5	2 + ⊕	 

DIN Valve Adapters

VAD 1A...M8 | VB 1A...M8



DIN Valve Adapter with M8 Connection

Valve adaptor according to DIN EN 175301-803, form A, with LED function indicator, varistor voltage protection, connected protective earth, with M8 male receptacle connector.

VAD 1A...M8

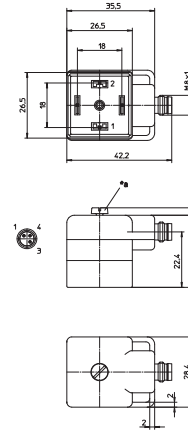

*a M3 screw



DIN Valve Adapter with M8 Connection

Valve adaptor according to DIN EN 175301-803, form B, with LED function indicator, varistor voltage protection, connected protective earth, with M8 male receptacle connector.

VB 1A...M8

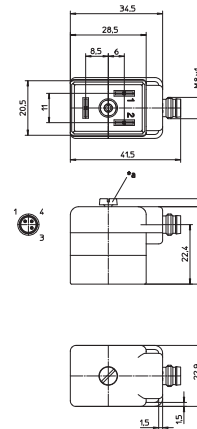

*a M3 screw

Pin Assignments

Face Views

VAD 1A-1-3-M8-3



VB 1A-1-2-M8-3



Wiring Diagram

VAD 1A-1-3-M8-3

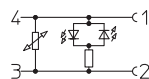

VB 1A-1-2-M8-3

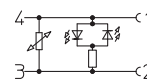



Be Certain with Belden

DIN Valve Adapters

VAD 1A...M8 | VB 1A...M8

Technical Data

Environmental

Degree of protection IP 67 / NEMA 6P
 Operating temperature range -25°C (-13°F) / +80°C (+176°F)

Mechanical

Housing / Molded body VAD/VB: TPU, self-extinguishing
 M8: CuZn, nickel-plated
 Insert VAD/VB: PBT
 M8: PA
 Contact VAD/VB: CuZn, pre-nickel-
 and tin-plated
 M8: CuZn, pre-nickel- and
 0.8 microns gold-plated

Electrical

Contact resistance $\leq 5 \text{ m}\Omega$
 Nominal current at 40°C 4 A
 Nominal voltage 24 V
 Rated voltage 32 V
 Insulation resistance $> 10^9 \Omega$
 Pollution degree 3

Varistor data

Nominal voltage 47 V at 0.1 mA
 typ. limiting voltage 110 V at 5 A
 max. pulse energy (standard impulse 10/1000us) 0.9 Ws
 max. continuous power loss 0.01 W

Accessories (incl.)

Attachable label
 Screw (fitted)

Part Number	Pins	Characteristics
VAD 1A-1-3-M8-3 VB 1A-1-2-M8-3	2	

M8-Receptacle Connectors In Accordance With IEC 61076-2-104

RSMHL.../S 5.5 | RKMHL.../S 5.5



Male, 3- and 4-Pole

Receptacle connector, M8 male connector for back mounting, printed contacts, chassis side thread M10 x 1 (panel nut included).

RSMHL.../S 5.5

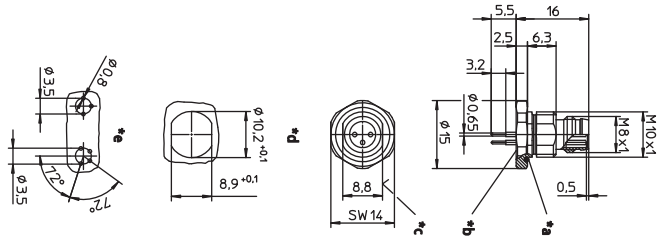

- *a O-ring
- *b solder contacts potted with epoxy
- *c anti-rotation protection
- *d cut out for anti-rotation
- *e hole pattern in printed circuit board



Female, 3- and 4-Pole

Receptacle connector, M8 female connector for back mounting, printed contacts, chassis side thread M10 x 1 (panel nut included).

RKMHL.../S 5.5

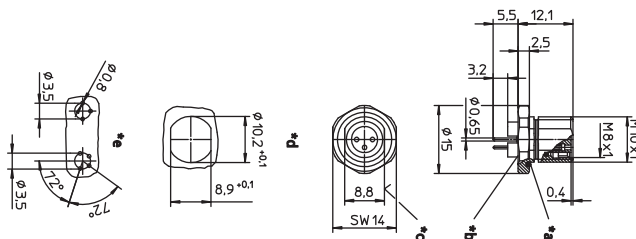

- *a O-ring
- *b solder contacts potted with epoxy
- *c anti-rotation protection
- *d cut out for anti-rotation
- *e hole pattern in printed circuit board

Pin Assignments

Face Views

M8 - 3 poles

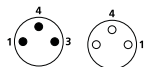

M8 - 4 poles

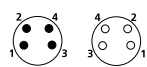



Be Certain with Belden

M8-Receptacle Connectors In Accordance With IEC 61076-2-104
 RSMHL.../S 5.5 | RKMHL.../S 5.5

Technical Data

Environmental

Degree of protection IP 67 / NEMA 6P
 Operating temperature range -25°C (-13°F) / +80°C (+176°F)

Mechanical

Housing / Molded body CuZn, nickel-plated
 Insert RSMHL: PA
 RKMHL: TPU, self-extinguishing
 Contact CuZn, pre-nickel and 0.8 microns gold-plated
 O-ring FKM

Electrical

Contact resistance ≤ 5 mΩ
 Nominal current at 40°C 4 A
 Nominal voltage 3 poles 60 V
 4 poles 30 V
 encapsulated
 Test voltage 1.5 kV eff. / 60 s
 Insulation resistance > 10⁹ Ω
 Pollution degree 3

Receptacles

Part Number		Pins	Characteristics
RSMHL 3/S 5,5	RKMHL 3/S 5,5	3	
RSMHL 4/S 5,5	RKMHL 4/S 5,5	4	

M8-Receptacle Connectors In Accordance With IEC 61076-2-104

RSMF/0.5 M | RKMf/0.5 M



Male, 3-, 4-, and 8-Pole

Receptacle connector, M8 male connector for front mounting, assembled stranded wire, solder contacts potted with epoxy, chassis side thread M8 x 0.5 (panel nut RSKF 8).

RSMF 3/0.5 M

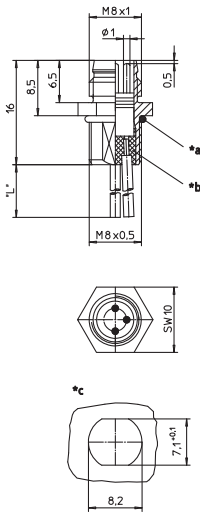

RSMF 8/0.5 M

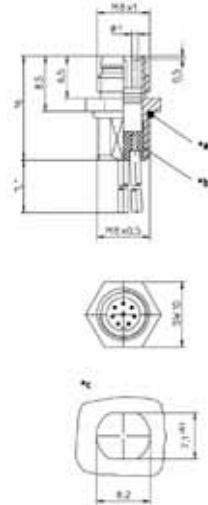

*a O-ring enclosed separately
 *b solder contacts potted with epoxy
 *c cut out
 L 0.5 m



Female, 3-, 4-, and 8-Pole

Receptacle connector, M8 female connector for front mounting, assembled stranded wire, solder contacts potted with epoxy, chassis side thread M8 x 0.5 (panel nut RSKF 8).

RKMf/0.5 M

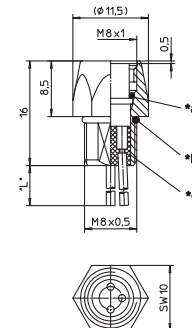

*d O-Ring
 *b O-ring enclosed separately
 *c solder contacts potted with epoxy
 *d cut out
 *L*0.5 m

Pin Assignments

Face Views

M8 - 3 poles

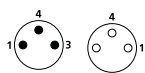

1 = brown
 2 = blue
 4 = black

M8 - 4 poles

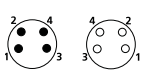

1 = brown
 2 = white
 3 = blue
 4 = black

M8 - 8 poles

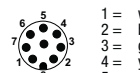

1 = white
 2 = brown
 3 = green
 4 = yellow
 5 = grey
 6 = pink
 7 = blue
 8 = red



Be Certain with Belden

M8-Receptacle Connectors In Accordance With IEC 61076-2-104
RSMF/0.5 M | RKMF/0.5 M

Technical Data

Environmental

Degree of protection IP 67 / NEMA 6P
Operating temperature range -25°C (-13°F) / +80°C (+176°F)

Mechanical

Housing / Molded body CuZn, nickel-plated
Insert PA
Contact CuZn, pre-nickel and 0.8 microns gold-plated
O-ring FKM

Electrical

Contact resistance RSMF: ≤ 5 mΩ
Nominal current at 40°C RSMF 8: 1 A
RSMF: 4 A
Nominal voltage 60 V
RSMF 8: 32 V
Test voltage 1.5 kV eff. / 60 s
RSMF 8: 0.8 kV eff. / 60 s
Insulation resistance > 10⁹ Ω
Pollution degree 3

Part Number		Pins	Characteristics
RSMF 3/0,5 M	RKMF 3/0,5 M	3	 
RSMF 4/0,5 M	RKMF 4/0,5 M	4	 
RSMF 8/0,5 M		8	 

M8-Receptacle Connectors In Accordance With IEC 61076-2-104

RSME | RSMEK | RSMEK...L



Male, 3-Pole

Receptacle connector, M8 male connector for sensors, with long solder contacts, solid contacts on solder side.

RSME

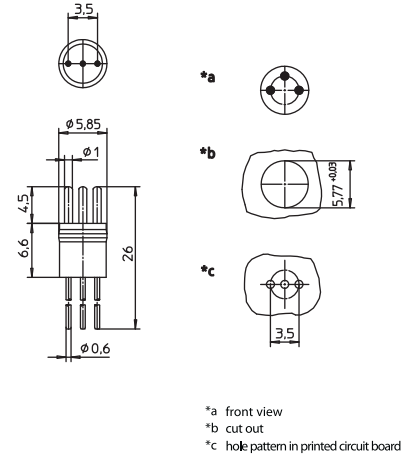

Male, 3- and 4-Pole

Receptacle connector, M8 male connector for sensors, with short solder contacts, solid contacts on solder side, RSMEK...L: with ventilation hole 1.1 mm Ø.

RSMEK | RSMEK...L

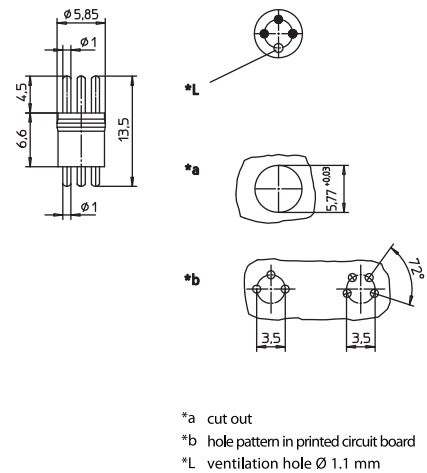

Pin Assignments

Face Views

M8 - 3 and 4 poles

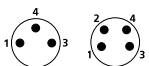



Be Certain with Belden

M8-Receptacle Connectors In Accordance With IEC 61076-2-104
 RSME | RSMEK | RSMEK...L

Technical Data

Environmental

Degree of protection IP 67 / NEMA 6P
 Operating temperature range -25°C (-13°F) / +80°C (+176°F)

Mechanical

Insert PA
 Contact CuZn, pre-nickel and 0.8 microns gold-plated

Electrical

Contact resistance $\leq 5 \text{ m}\Omega$
 Nominal current at 40°C 4 A
 Nominal voltage 60 V
 Rated voltage 63 V
 Test voltage 1.5 kV eff. / 60 s
 Insulation resistance $> 10^9 \Omega$
 Pollution degree 3

Receptacles

Part Number	Pins	Ventilation hole	Contact (soldering side)	Characteristics
RSME 3	3		solid contact	
RSMEK 3L		1.1 mm Ø	solid contact	
RSMEK 4	4		solid contact	

M8-Receptacle Connectors In Accordance With IEC 61076-2-104

RSEM



Male, 8-Pole

Receptacle connector, M8 male connector for sensors, with long solder contacts, solid contacts on solder side.

RSEM

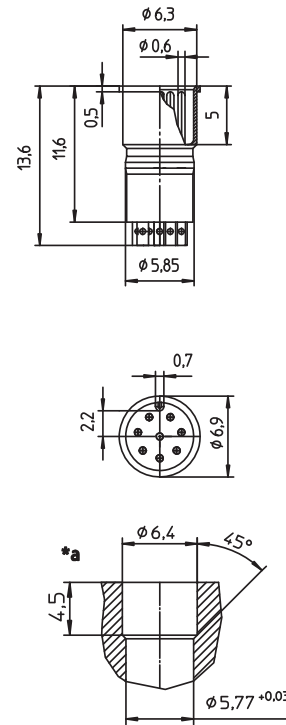

*a cut out

Pin Assignments

Face Views

M8 - 8 poles





Be Certain with Belden

M8-Receptacle Connectors In Accordance With IEC 61076-2-104
RSEM

Technical Data

Environmental

Degree of protection IP 67 / NEMA 6P
 Operating temperature range -25°C (-13°F) / +80°C (+176°F)

Mechanical

Insert PA
 Contact CuZn, pre-nickel and 0.8 microns gold-plated
 Mode of connection solder connection

Electrical

Nominal current at 40°C 1 A
 Nominal voltage 32 V
 Test voltage 0.8 kV eff. / 60 s
 Insulation resistance > 10⁹ Ω
 Pollution degree 3

Receptacles

Part Number	Pins	Contact (soldering side)	Characteristics
RSEM 8	8	solid contact	

M8-Receptacle Connectors In Accordance With IEC 61076-2-104

RSMEJ | RSMEH | RSMED | RSMEB



Male, 3 and 4-Pole

Receptacle connector, M8 male connector for sensors, with snap-in joint, translucent ring, short solder contacts, hollow contacts (RSMEJ) or solid contacts (RSMEH) on solder side.

RSMEJ | RSMEH

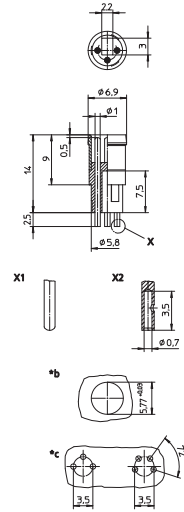

*X1 solid
*X2 hollow
*b cut out
*c hole pattern in printed circuit board



M8 Male, 3 and 4-Pole

Receptacle connector, M8 male connector for sensors, with combined snap-in/threaded joint, 4 light indicator windows, mounting hole for LED, short solder contacts, hollow contacts (RSMED) or solid contacts (RSMEB) on solder side

RSMED | RSMEB

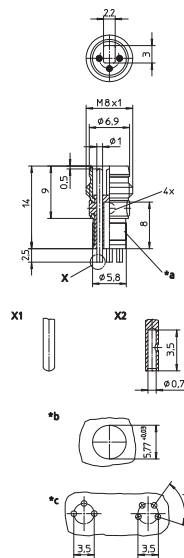

*X1 solid
*X2 hollow
*b cut out
*c hole pattern in printed circuit board

Pin Assignments

Face Views

M8 - 3 and 4 poles

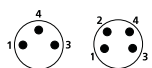



Be Certain with Belden

M8-Receptacle Connectors In Accordance With IEC 61076-2-104

RSMEJ | RSMEH | RSMED | RSMEB

Technical Data

Environmental









Degree of protection IP 67 / NEMA 6P
 Operating temperature range -25°C (-13°F) / +80°C (+176°F)

Mechanical

Housing / Molded body CuZn, nickel-plated
 Insert PA
 Contact CuZn, pre-nickeled and 0.8 microns gold-plated
 Mode of connection solder connection
 Connectable conductor max. 0.25 mm²

Electrical

Contact resistance ≤ 5 mΩ
 Nominal current at 40°C 4 A
 Nominal voltage 60 V
 Rated voltage 63 V
 Test voltage 1.5 kV eff. / 60 s
 Insulation resistance > 10⁹ Ω
 Pollution degree 3

Part Number		Pins	Contact (soldering side)	Characteristics
RSMEJ 3	RSMED 3	3	hollow contact	 
RSMEH 3	RSMEB 3		solid contact	 
	RSMED 4	4	hollow contact	 
RSMEH 4	RSMEB 4		solid contact	 

M8-Receptacle Connectors In Accordance With IEC 61076-2-104

RSMEDG | RSMEDGN



Male, 8-Pole

Receptacle connector, M8 male connector for sensors, with combined snap-in/threaded joint, mounting hole for LED, short solder contacts, hollow contacts on solder side.

RSMEDG

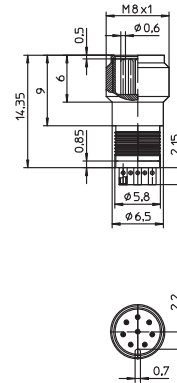

Male, 3 and 4-Pole

Receptacle connector, M8 male connector for sensors, with housing of stainless steel, threaded joint, 4 light indicator windows, mounting hole for LED, short solder contacts, hollow contact on solder side.

RSMEDGN

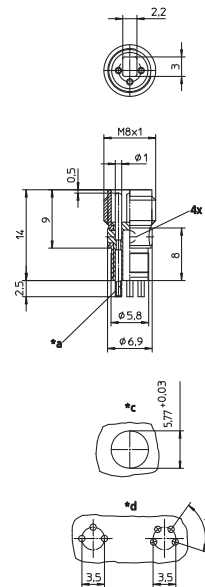

Pin Assignments

Face Views

M8 - 3 and 4 poles

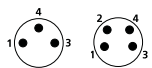

M8 - 8 poles



*a hollow
*c cut out
*d hole pattern in printed circuit board



Be Certain with Belden

M8-Receptacle Connectors In Accordance With IEC 61076-2-104
 RSMEDG | RSMEDGN

Technical Data

Environmental

Degree of protection IP 67 / NEMA 6P
 Operating temperature range -25°C (-13°F) / +80°C (+176°F)

Mechanical

Housing / Molded body CuZn, nickel-plated
 Insert PA
 Contact CuZn, pre-nickel and 0.8 microns gold-plated
 Mode of connection solder connection
 Connectable conductor max. 0.14 mm²

Electrical

Contact resistance ≤ 5 mΩ
 Nominal current at 40°C 1.5 A
 Nominal voltage 30 V
 Test voltage 0.5 kV eff. / 60 s
 Insulation resistance > 10⁹ Ω
 Pollution degree 3

Receptacles

Part Number	Pins	Contact (soldering side)	Characteristics
RSMEDGN 3	3		
RSMEDGN 4	4		
RSMEDG 8	8	hollow contact	

M12-Receptacle Connectors In Accordance With IEC 61076-2-101

RSHL | RKHL | 0986 EFC 152



Male, 4-, 5- and 8-Pole

Receptacle connector, M12 male connector for rear mounting, 4-, 5-, and 8-pole, print contacts, chassis side thread PG 9 (panel nut RSKF 9).

RSHL

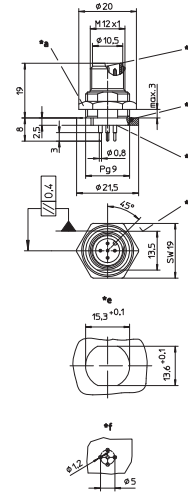

- *a nut
- *b O-Ring
- *c solder contacts potted with epoxy
- *d anti-rotation protection
- *e cut out for anti-rotation
- *f hole pattern in printed circuit board



Female, 4-, 5- and 8-Pole

Receptacle connector, M12 female connector for rear mounting, 4-, 5-, and 8-pole, printed contacts, chassis side thread PG 9 (panel nut RSKF 9) 0986 EFC 152: 4 poles, D coding.

RKHL

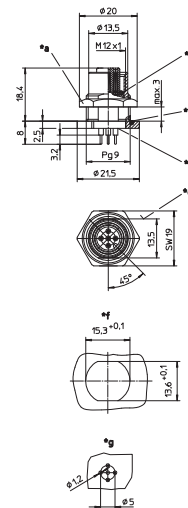

- *a nut
- *b O-Ring
- *c solder contacts potted with epoxy
- *d anti-rotation protection
- *e cut out for anti-rotation
- *f hole pattern in printed circuit board
- *v center contact leading

Pin Assignments

Face Views / M12

4 poles

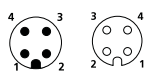

4 poles D-Coding



5 poles

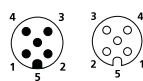

8 poles

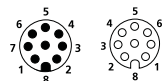



Be Certain with Belden

M12-Receptacle Connectors In Accordance With IEC 61076-2-101

RSHL | RKHL | 0986 EFC 152

Technical Data

Environmental

Degree of protection IP 67 / NEMA 6P
 Operating temperature range -25°C (-13°F) / +80°C (+176°F)

Mechanical

Housing / Molded body CuZn, nickel-plated
 Insert PA
 Contact CuZn, pre-nickeled and 0.8 microns gold-plated
 O-ring FKM2

Electrical

Contact resistance ≤ 5 mΩ
 Nominal current at 40°C 4-5 poles 4 A
 8 poles 2 A
 Nominal voltage 4 poles 240 V;
 5-8 poles 60 V
 encapsulated
 Rated voltage 4 poles 250 V;
 5-8 poles 63 V
 Test voltage 4 poles 2.0 kV eff. / 60 s
 5-8 poles 1.5 kV eff. / 60 s
 Insulation resistance > 10⁹ Ω
 Pollution degree 3

Part Number		Pins	Characteristics
RSHL 4/S 5.5	RKHL 4/S 5.5	4	
	0976 EFC 152	4D	
RSHL 5/S 5.5	RKHL 5/S 5.5	5	
RSHL 8/S 5,5	RKHL 8/S 5,5	8	

M12-Receptacle Connectors In Accordance With IEC 61076-2-101

RSFM | PRSFM



Male, 3-, 4- and 5-Pole

Receptacle connector, combined FIXCON/M12 male connector for front mounting, solder connections, chassis side thread M16 x 1.5 (panel nut RSKFM 16).

RSFM

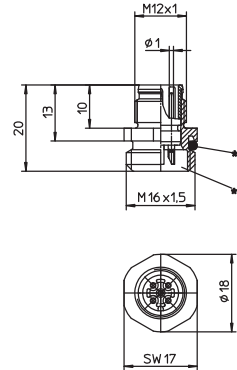

*a O-ring enclosed separately
*b Attention!
To ensure mechanical stability and impermeability, the wire connections must be epoxy potted after cable assembly.



Male, 3-, 4- and 5-Pole

Receptacle connector, M12 male connector for front mounting, housing of stainless steel, solder contacts not potted, chassis side thread M16 x 1.5 (panel nut RSKFM 16)

– especially designed for use in food processing equipment –.

PRSFM

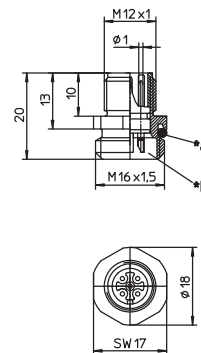

*a O-ring enclosed separately
*b Attention!
To ensure mechanical stability and impermeability, the wire connections must be epoxy potted after cable assembly.

Pin Assignments

Face Views / M12

3 poles



4 poles



5 poles





Be Certain with Belden

M12-Receptacle Connectors In Accordance With IEC 61076-2-101 RSFM | PRSFM

Technical Data

Environmental

Degree of protection	IP 67 / NEMA 6P
Operating temperature range	RSFM: -25°C (-13°F) / +80°C (+176°F) PRSFM: -25°C (-13°F) / +70°C (+158°F)

Mechanical

Housing / Molded body	RSFM: CuZn, nickel-plated PRSFM: stainless steel
Insert	RSFM: PA PRSFM: PBT
Contact	CuZn, pre-nickel and 0.8 microns gold-plated
O-ring	RSFM: FKM PRSFM: EPDM

Electrical

Contact resistance	≤ 5 mΩ
Nominal current at 40°C	4 A
Nominal voltage	3–4 poles 240 V 5 poles 60 V Connection area must be epoxy potted.
Rated voltage	3–4 poles 250 V 5 poles 63 V
Test voltage	3–4 poles 2.0 kV eff. / 60 s 5–8 poles 1.5 kV eff. / 60 s
Insulation resistance	> 10 ⁹ Ω
Pollution degree	3

Part Number	Pins	Characteristics
RSFM 3	3	
RSFM 4	4	
PRSFM 4		
RSFM 5	5	
PRSFM 5		

M12-Receptacle Connectors In Accordance With IEC 61076-2-101

FWD 5 | FWD 5B



Male, 5-Pole

Receptacle connector, combined FIXCON/M12 male connector to combined FIXCON/M12 female connector.

– especially designed for use as panel feed through –

FWD 5 | FWD 5B

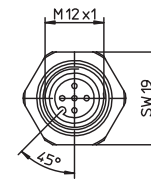
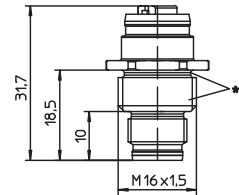

Pin Assignments

Face Views / M12

Male Connector : 5 poles



Female Connector: 5 poles



Male Connector: 5 poles B Coding



Female Connector: 5 poles B Coding





Be Certain with Belden

M12-Receptacle Connectors In Accordance With IEC 61076-2-101
 FWD 5 | FWD 5B

Technical Data

Environmental

Degree of protection IP 67 / NEMA 6P
 Operating temperature range -25°C (-13°F) / +80°C (+176°F)

Mechanical

Housing / Molded body CuZn, nickel-plated
 Insert Male connector PA 6.6
 Insert Female connector TPU, self-extinguishing
 Contact CuZn, pre-nickeled and 0.8 microns gold-plated
 O-ring FKM

Electrical

Contact resistance ≤ 5 mΩ
 Nominal current at 40°C 4 A
 Nominal voltage 60 V
 Test voltage 1.5 kV eff. / 60 s
 Insulation resistance > 10⁹ Ω
 Pollution degree 3

Part Number	Pins	Characteristics
FWD 5	5	
FWD 5B	5B	

M12-Receptacle Connectors In Accordance With IEC 61076-2-101

RSF 3...8 | RKF 3...8



Male, 3-, 4-, 5- and 8-Pole

Receptacle, 3-, 4-, 5-, and 8-pole, male, M12 for front mounting, 24 and 22 AWG, panel mount thread PG9.

RSF 3...8

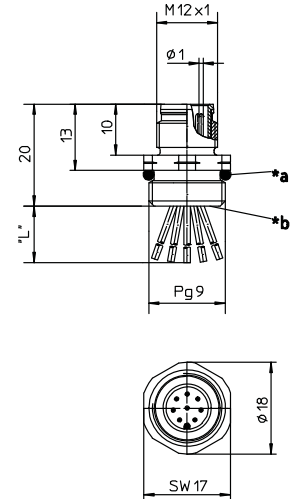

Female, 3-, 4-, 5- and 8-Pole

Receptacle, 3-, 4-, 5-, and 8-pole, female, M12 for front mounting, 24 and 22 AWG, panel mount thread PG9.

RKF 3...8

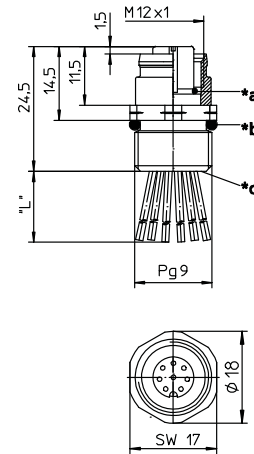

Pin Assignments

Face Views / M12, Male / Female

3 pole

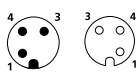

1 = brown
2 = n.c.
3 = blue
4 = black

4 pole

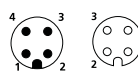

1 = brown
2 = white
3 = blue
4 = black

5 pole

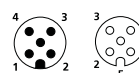

1 = brown
2 = white
3 = blue
4 = black
5 = green/yellow

8 pole

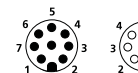

1 = white
2 = brown
3 = green
4 = yellow
5 = grey
6 = pink
7 = blue
8 = red



Be Certain with Belden

M12-Receptacle Connectors In Accordance With IEC 61076-2-101
 RSF 3...8 | RKF 3...8

Technical Data

Environmental

Degree of protection IP 67 / NEMA 6P
 Operating temperature range -25°C (-13°F) / +90°C (+194°F)

Mechanical









Housing Brass, nickel-plated
 Insert PUR, black (female)
 3-, 4- and 5-Pole: Nylon (male)
 8-Pole: PUR, black (male)
 Contact Brass, gold over nickel-plated

Electrical

Current rating 3-5 Pole: 4 A
 8 Pole: 1.5 A
 Voltage rating 3-5 Pole: 250 V
 8 Pole: 30 V / 36 V DC

Accessories

Panel nut (RSKF 9)

Part Number		Pins	Characteristics
RSF 3/0.5M	RKF 4-3/0.5M	3	 
RSF 4/0.5M	RKF 4/0.5M	4	 
RSF 5/0.5M	RKF 5/0.5M	5	 
RSF 8/0.5M	RKF 8/0.5M	8	 

M12-Receptacle Connectors In Accordance With IEC 61076-2-101

RSF S3103 | RKF S3103



Male, 3-, 4-, 5- and 8-Pole

Receptacle, 3-, 4-, 5- and 8-pole, male, M12 for back mounting, 24 and 22 AWG, panel mount thread PG9.

RSF S3103

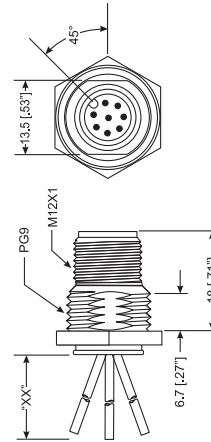

Female, 3-, 4-, 5- and 8-Pole

Receptacle, 3-, 4-, 5- and 8-pole, female, M12 for back mounting, 24 and 22 AWG, panel mount thread PG9.

RKF S3103

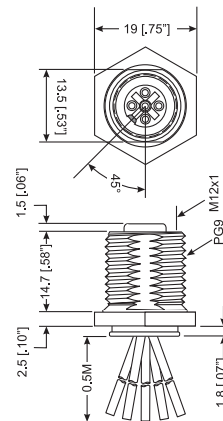

Pin Assignments

Face Views / M12, Male / Female

3 pole

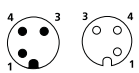

- 1 = brown
- 2 = n.c.
- 3 = blue
- 4 = black

4 pole

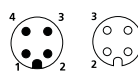

- 1 = brown
- 2 = white
- 3 = blue
- 4 = black

5 pole

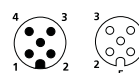

- 1 = brown
- 2 = white
- 3 = blue
- 4 = black
- 5 = green/yellow

8 pole

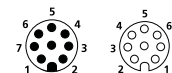

- 1 = white
- 2 = brown
- 3 = green
- 4 = yellow
- 5 = grey
- 6 = pink
- 7 = blue
- 8 = red



Be Certain with Belden

M12-Receptacle Connectors In Accordance With IEC 61076-2-101
 RSF S3103 | RKF S3103

Technical Data

Environmental

Degree of protection IP 67 / NEMA 6P
 Operating temperature range -25°C (-13°F) / +90°C (+194°F)

Mechanical









Housing Brass, nickel-plated
 Insert PUR, black (female)
 3-, 4- and 5-Pole: Nylon, black (male)
 8-Pole: PUR, orange (male)
 Contact Brass, gold over nickel-plated

Electrical

Current rating 3-5 Pole: 4 A
 8 Pole: 1.5 A
 Voltage rating 3-5 Pole: 250 V
 8 Pole: 30 V / 36 V DC

Accessories

Panel nut (RSKF 9)

Part Number		Pins	Characteristics
RSF 3-S3103/0.5 M	RKF 4-3-S3103/0.5 M	3	 
RSF 4-S3103/0.5 M	RKF 4-S3103/0.5 M	4	 
RSF 5-S3103/0.5 M	RKF 5-S3103/0.5 M	5	 
RSF 8-S3103/0.5 M	RKF 8-S3103/0.5 M	8	 

M12-Receptacle Connectors In Accordance With IEC 61076-2-101

RSF 1/2-14 | RKF 1/2-14



Male, 3-, 4-, 5- and 8-Pole

Receptacle, 3-, 4-, 5- and 8-pole, male, M12 for front mounting, 24 and 22 AWG, panel mount thread 1/2"-14 NPT.

RSF 1/2-14

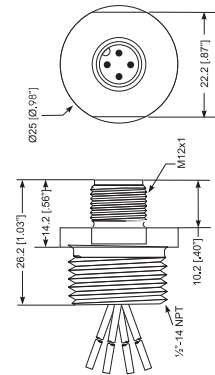

Female, 3-, 4-, 5- and 8-Pole

Receptacle, 3-, 4-, 5- and 8-pole, female, M12 for front mounting, 24 and 22 AWG, panel mount thread 1/2"-14 NPT.

RKF 1/2-14

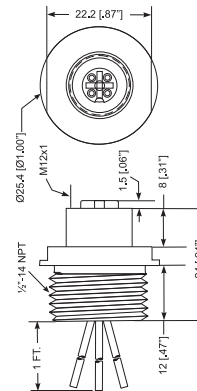

Pin Assignments

Face Views / M12, Male / Female

3 pole

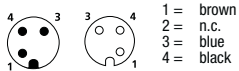

4 pole

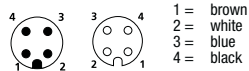

5 pole

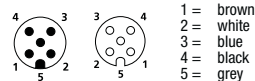

8 pole

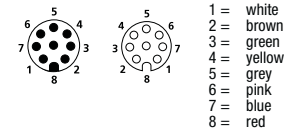



Be Certain with Belden

M12-Receptacle Connectors In Accordance With IEC 61076-2-101
 RSF 1/2-14 | RKF 1/2-14

Technical Data

Environmental









Degree of protection IP 67 / NEMA 6P
 Operating temperature range -25°C (-13°F) / +90°C (+194°F)

Mechanical

Housing Aluminum, blue anodized
 Insert PUR, black (female)
 3-, 4- and 5-Pole: Nylon, black (male),
 8-Pole: PUR, orange (male)
 Contact Brass, gold over nickel-plated
 Mounting 1/2" 14-NPT

Electrical

Nominal current 3-, 4- and 5-Pole: 4 A
 8-Pole: 1.5 A
 Voltage rating 3-, 4- and 5-Pole: 250 V
 8-pole: 30 V AC / 36 V DC

Part Number		Pins	Characteristics
RSF 3-1/2-14/0.5M	RKF 4-3-1/2-14/0.5M	3	 
RSF 4-1/2-14/0.5M	RKF 4-1/2-14/0.5M	4	 
RSF 5-1/2-14/0.5M	RKF 5-1/2-14/0.5M	5	 
RSF 8-1/2-14/0.5M	RKF 8-1/2-14/0.5M	8	 

M12-Receptacle Connectors In Accordance With IEC 61076-2-101

RSFM/0.5 M | RKFM/0.5 M



Male, 3-, 4-, 5- and 8-Pole

Receptacle connector, combined FIXCON/M12 male connector for front mounting, assembled stranded wire, solder contacts potted with epoxy, chassis side thread M16 x 1.5 (panel nut RSKFM 16).

RSFM/0.5 M

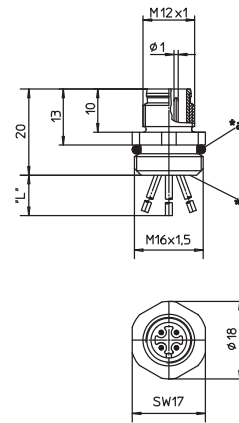

*a O-ring enclosed separately

*b solder contacts potted with epoxy

L 0,5 m



Female, 3-, 4-, 5- and 8-Pole

Receptacle connector, combined FIXCON/M12 female connector for front mounting, assembled stranded wire, solder contacts potted with epoxy, chassis side thread M16 x 1.5 (panel nut RSKFM 16).

RKFM/0.5 M

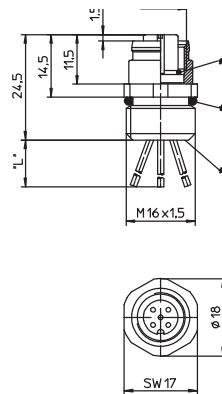

*a O-Ring

*b O-ring enclosed separately

*c solder contacts potted with epoxy

Pin Assignments

Face Views / M12, Male / Female

3 pole

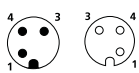

1 = brown
3 = blue
4 = black

4 pole

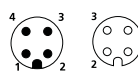

1 = brown
2 = white
3 = blue
4 = black

5 pole

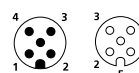

1 = brown
2 = white
3 = blue
4 = black
5 = green/yellow

8 pole

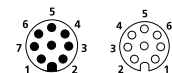

1 = white
2 = brown
3 = green
4 = yellow
5 = grey
6 = pink
7 = blue
8 = red



Be Certain with Belden

M12-Receptacle Connectors In Accordance With IEC 61076-2-101
 RSFM/0.5 M | RKFM/0.5 M

Technical Data

Environmental









Degree of protection IP 67 / NEMA 6P
 Operating temperature range -25°C (-13°F) / +80°C (+176°F)

Mechanical

Housing / Molded body CuZn, nickel-plated
 Insert PA
 8 poles TPU
 Contact CuZn, pre-nickel and 0.8 microns gold-plated
 O-ring FKM

Electrical

Contact resistance ≤ 5 mΩ
 Nominal current at 40°C 3–5 poles 4 A
 8 poles 1,5 A
 Nominal voltage 3–4 poles 240 V
 5 poles 60 V
 poles 30 V
 Rated voltage 3–4 poles 250 V
 5 poles 63 V
 8 poles 36 V
 Test voltage 3–4 poles 2.0 kV eff. / 60 s
 5–8 poles 1.5 kV eff. / 60 s
 Insulation resistance > 10⁹ Ω
 Pollution degree 3

Part Number		Pins	Leads (mm ²)	Characteristics
RSFM 3/0.5 M	RKFM 4-3/0.5 M	3	0.34	 
RSFM 4/0.5 M	RKFM 4/0.5 M	4	0.34	 
RSFM 5/0.5 M	RKFM 5/0.5 M	5	4 x 0.34 / 1 x 0.50	 
RSFM 8/0.5 M	RKFM 8/0.5 M	8	0.25	 

M12-Receptacle Connectors In Accordance With IEC 61076-2-101

RSFM.../20/0.5 M | RKF.../20/0.5 M



Male, 3- and 4-Pole

M12 Receptacle connector, combined FIXCON/ M12 male connector for front mounting, assembled stranded wire, solder contacts potted with epoxy, chassis side thread M20 x 1.5 (panel nut RSKFM 20).

RSFM.../20/0.5 M

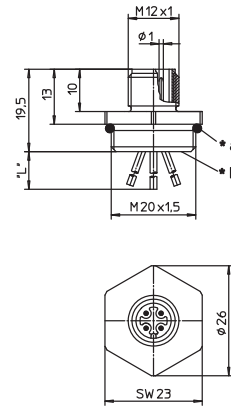

*a O-ring enclosed separately
 *b solder contacts potted with epoxy
 *L*0,5 m



M12 Female, 3-, 4-, and 5-Pole

M12 Receptacle connector, combined FIXCON/ M12 female connector for front mounting, assembled stranded wire, solder contacts potted with epoxy, chassis side thread M20 x 1.5 (panel nut RSKFM 20).

RKF.../20/0.5 M

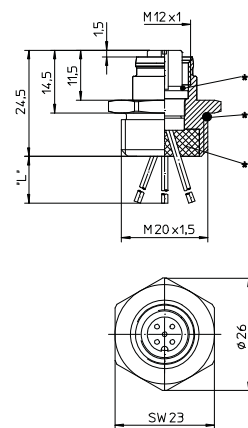

Pin Assignments

Face Views / M12, Male / Female

3 pole

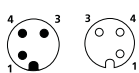

1 = brown
 3 = blue
 4 = black

4 pole

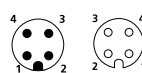

1 = brown
 2 = white
 3 = blue
 4 = black

5 pole

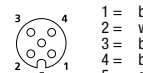

1 = brown
 2 = white
 3 = blue
 4 = black
 5 = green/yellow



Be Certain with Belden

M12-Receptacle Connectors In Accordance With IEC 61076-2-101
 RSFM.../20/0.5 M | RKFM.../20/0.5 M

Technical Data

Environmental







Degree of protection IP 67 / NEMA 6P
 Operating temperature range -25°C (-13°F) / +80°C (+176°F)

Mechanical

Housing / Molded body CuZn, nickel-plated
 Insert PA
 Contact 8 poles TPU
 CuZn, pre-nickeled and 0.8 microns gold-plated
 O-ring FKM

Electrical

Contact resistance ≤ 5 mΩ
 Nominal current at 40°C 3-5 poles 4 A
 8 poles 1,5 A
 Nominal voltage 3-4 poles 240 V
 5 poles 60 V
 poles 30 V
 Rated voltage 3-4 poles 250 V
 5 poles 63 V
 8 poles 36 V
 Test voltage 3-4 poles 2.0 kV eff. / 60 s
 5-8 poles 1.5 kV eff. / 60 s
 Insulation resistance > 10⁹ Ω
 Pollution degree 3

Part Number	Pins	Lead (mm ²)	Characteristics
RSFM 3/20/0.5 M	3	0.34	 
RSFM 4/20/0.5 M	4	0.34	 
RKFM 5/20/0.5 M	5	4 x 0.34 / 1 x 0.50	 

M12-Receptacle Connectors In Accordance With IEC 61076-2-101

RSFPM.../0.5 M | RKFPM.../0.5 M



Male, 3-, 4-, 5- and 8-Pole

M12 Receptacle connector, combined FIXCON/ M12 male connector for front mounting, adjustable, assembled stranded wire, solder contacts potted with epoxy, chassis side thread M16 x 1.5.



Female, 3-, 4-, 5- and 8-Pole

M12 Receptacle connector, combined FIXCON/ M12 female connector for front mounting, adjustable, assembled stranded wire, solder contacts potted with epoxy, chassis side thread M16 x 1.5.

RSFPM.../0.5 M

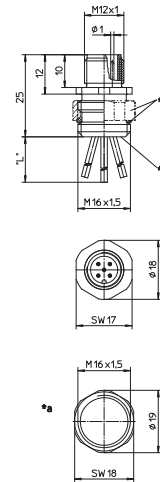

*a O-ring enclosed separately
*b solder contacts potted with epoxy
L*0.5 m

RKFPM.../0.5 M

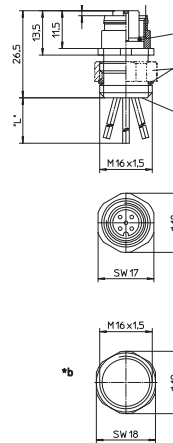

*a O-ring enclosed separately
*b solder contacts potted with epoxy
L*0.5 m

Pin Assignments

Face Views / M12, Male / Female

3 pole

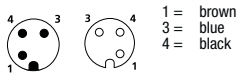

4 pole

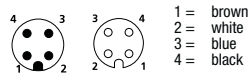

5 pole

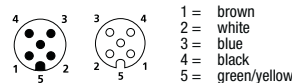

8 pole

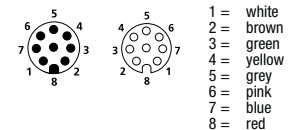



Be Certain with Belden

M12-Receptacle Connectors In Accordance With IEC 61076-2-101
 RSFPM.../0.5 M | RKFPM.../0.5 M

Technical Data

Environmental









Degree of protection IP 67 / NEMA 6P
 Operating temperature range -25°C (-13°F) / +80°C (+176°F)

Mechanical

Housing / Molded body CuZn, nickel-plated
 Insert PA
 Contact 8 poles TPU
 CuZn, pre-nickel and 0.8 microns gold-plated
 O-ring FKM
 RSFM.../20: Neoprene

Electrical

Contact resistance ≤ 5 mΩ
 Nominal current at 40°C 3–5 poles 4 A
 8 poles 1,5 A
 Nominal voltage 3–4 poles 240 V
 5 poles 60 V
 poles 30 V
 Rated voltage 3–4 poles 250 V
 5 poles 63 V
 8 poles 36 V
 Test voltage 3–4 poles 2.0 kV eff. / 60 s
 5–8 poles 1.5 kV eff. / 60 s
 Insulation resistance > 10⁹ Ω
 Pollution degree 3

Part Number		Pins	Lead (mm ²)	Characteristics
RSFPM 3/0,5 M	RKFPM 4-3/0,5 M	3	0.34	 
RSFPM 4/0,5 M	RKFPM 4/0,5 M	4	0.34	 
RSFPM 5/0,5 M	RKFPM 5/0,5 M	5	4 x 0.34 / 1 x 0.50	 
RSFPM 8/0,5 M	RKFPM 8/0,5 M	8	0.25	 

M12-Receptacle Connectors In Accordance With IEC 61076-2-101

PRSFM/0.5 M | PRKFM/0.5 M



Male, 4-, 5- and 8-Pole

M12 Receptacle connector, M12 male connector for front mounting, housing of stainless steel, assembled stranded wire, solder contacts potted with epoxy, chassis side thread M16 x 1.5 (panel nut RSKFM 16)
– especially designed for use in food processing equipment –

PRSFM/0.5 M

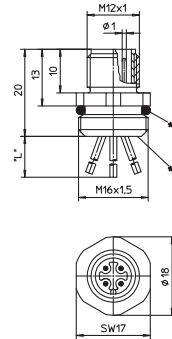

*a O-ring enclosed separately
*b solder contacts potted with epoxy
*L*0.5 m



Female, 4-, 5- and 8-Pole

M12 Receptacle connector, M12 female connector for front mounting, housing of stainless steel, assembled stranded wire, solder contacts potted with epoxy, chassis side thread M16 x 1.5 (panel nut RSKFM 16)
– especially designed for use in food processing equipment –

PRKFM/0.5 M

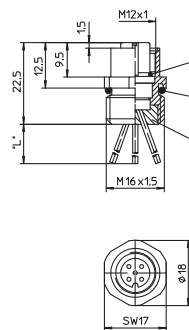

*a O-Ring
*b O-ring enclosed separately
*c solder contacts potted with epoxy
*L*0.5 m

Pin Assignments

Face Views / M12, Male / Female

4 pole

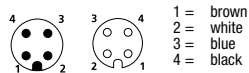

5 pole

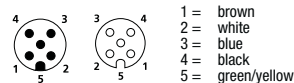

8 pole

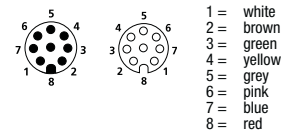



Be Certain with Belden

M12-Receptacle Connectors In Accordance With IEC 61076-2-101
 PRSFM/0.5 M | PRKFM/0.5 M

Technical Data

Environmental







Degree of protection IP 67 / NEMA 6P
 Operating temperature range -25°C (-13°F) / +70°C (+158°F)

Mechanical

Housing / Molded body stainless steel
 Insert PBT
 Contact CuZn, pre-nickel and 0.8 microns gold-plated
 O-ring EPDM

Electrical

Contact resistance ≤ 5 mΩ
 Nominal current at 40°C 4–5 poles 4 A
 8 poles 2 A
 Nominal voltage 4 poles 240 V
 5 poles 60 V
 8 poles 30 V
 Rated voltage 4 poles 250 V
 5 poles 63 V
 8 poles 36 V
 Test voltage 4 poles 2.0 kV eff. / 60 s
 5–8 poles 1.5 kV eff. / 60 s
 Insulation resistance > 10⁹ Ω
 Pollution degree 3

Part Number		Pins	Lead (mm ²)	Characteristics
PRSFM 4/0,5 M	PRKFM 4/0,5 M	3	0.34 (22 AWG)	 
PRSFM 5/0,5 M	PRKFM 5/0,5 M	5	1 x 0.5 / 4 x AWG 22	 
PRSFM 8/0,5 M	PRKFM 8/0,5 M	8	0.22 (24 AWG)	 

M12-Receptacle Connectors In Accordance With IEC 61076-2-101

0936 DMC 351 | 0936 DFC 351



Male, 5-Pole

Receptacle connector, M12 male connector for front mounting, 5 poles, adjustable, assembled stranded wire, solder contacts potted with epoxy, chassis side thread M16 x 1.5.

– especially suitable for DeviceNet and CANopen –

0936 DMC 351

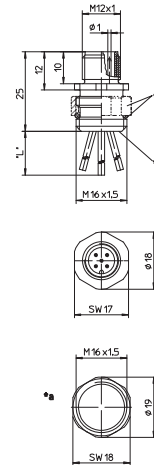

*a adjustable nut and o-ring enclosed separately
*b solder contacts potted with epoxy
L*0.5 m



Female, 5-Pole

Receptacle connector, M12 female connector for front mounting, 5 poles, adjustable, assembled stranded wire, solder contacts potted with epoxy, chassis side thread M16 x 1.5.

– especially suitable for DeviceNet and CANopen –

0936 DFC 351

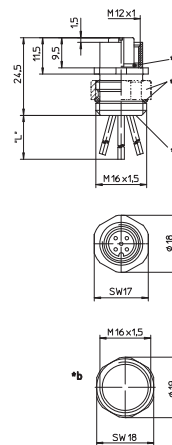

*a adjustable nut and o-ring enclosed separately
*b solder contacts potted with epoxy
L*0.5 m

Pin Assignments

Face Views / M12

Male / Female Connector: 5 poles

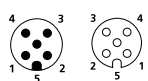

- 1 = green
- 2 = red
- 3 = black
- 4 = white
- 5 = blue



Be Certain with Belden

M12-Receptacle Connectors In Accordance With IEC 61076-2-101
 0936 DMC 351 | 0936 DFC 351

Technical Data

Environmental

Degree of protection IP 67 / NEMA 6P
 Operating temperature range -25°C (-13°F) / +80°C (+176°F)



Mechanical

Housing / Molded body CuZn, nickel-plated
 Insert TPU, self-extinguishing
 Contact CuZn, pre-nickeled and 0.8 microns gold-plated
 O-ring FKM
 Adjustable nut CuZn, nickel-plated

Electrical

Contact resistance $\leq 5 \text{ m}\Omega$
 Nominal current at 40°C 4 A
 Nominal voltage 60 V
 Test voltage 1.5 kV eff. / 60 s
 Insulation resistance $> 10^9 \Omega$
 Pollution degree 3

Receptacles

Part Number	Pins	Lead (mm ²)	Characteristics
0936 DMC 351 0936 DFC 351	5	0.22	 

M12-Receptacle Connectors In Accordance With IEC 61076-2-101

RSF 5 TB | RKF 5 TB



Male, 5-Pole to Terminal Block

Receptacle, 5-pole, male to terminal block receptacle.

– especially suitable for panel-mount/
feedthrough applications –

RSF 5 TB

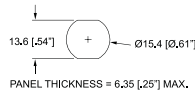
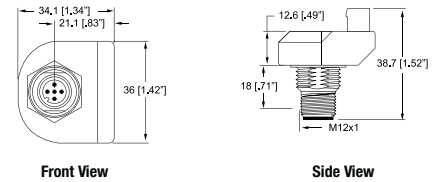

Recommended Panel
Cut-Out

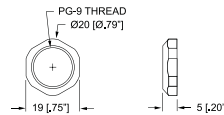

Panel Nut Dimensions

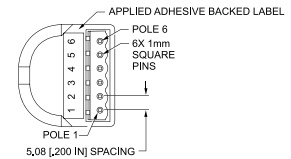

Rear View



Female, 5-Pole to Terminal Block

Receptacle, 5-pole, female to terminal block receptacle.

– especially suitable for panel-mount/
feedthrough applications –

RKF 5 TB

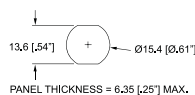
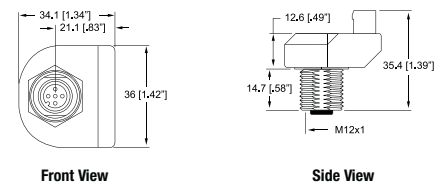

Recommended Panel
Cut-Out

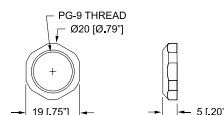

Panel Nut Dimensions

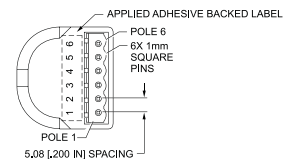

Rear View

Pin Assignments

Face Views / M12

Male / Female

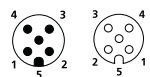

Wiring Diagram

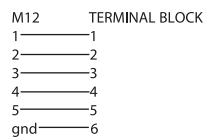



Be Certain with Belden

M12-Receptacle Connectors In Accordance With IEC 61076-2-101
 RSF 5 TB | RKF 5 TB

Technical Data

Environmental

Degree of protection IP 67 / NEMA 6P
 Operating temperature range -25°C (-13°F) / +90°C (+194°F)

Mechanical

M12 Connector
 Shell CuZn, nickel plated
 Panel Nut CuZn, nickel plated
 Contacts CuZn, gold plated
 Insert Polyurethane, black
 Sealing Viton
 Terminal Block Receptacle
 Header Body Polyamide 66, green
 Pins CuZn, tin plated
 Overmold Polyamide, black

Electrical

Current rating 4 A
 Voltage rating 250 V

Recommended Mating Terminal Block

(Lumberg Part Numbers)
 MC 100-508-06 180° wire exit
 MC 200-508-06 90° wire exit (included)

Part Number	Pins	Characteristics
RSF 5 TB RKF 5 TB	5	

M12-Receptacle Connectors In Accordance With IEC 61076-2-101

RSE | RSEQ



M12 Male, 4- and 5-Pole

Receptacle connector, M12 male connector for sensors, with short solder contacts RSE0: Pin 5 not leading (RSE and RSEQ).

RSE | RSEQ

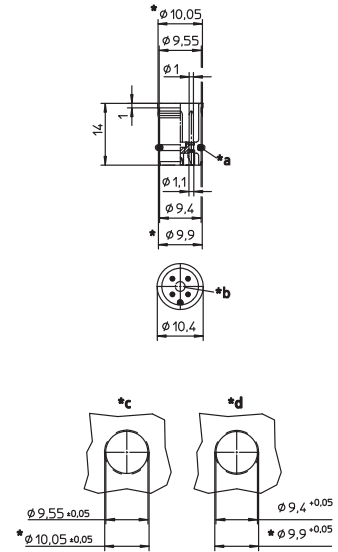

- *a O-ring enclosed separately
- *b ventilation hole
- *c cut out with O-ring
- *d cut out without O-ring

Pin Assignments

Face Views / M12 Male

4 pole



5 pole





Be Certain with Belden

M12-Receptacle Connectors In Accordance With IEC 61076-2-101
RSE | RSEQ

Technical Data

Environmental





Degree of protection IP 67 / NEMA 6P
Operating temperature range -25°C (-13°F) / +80°C (+194°F)

Mechanical

Insert PA
Contact CuZn, pre-nickel and 0.8 microns gold-plated
O-ring FKM
Mode of connection solder connection
Connectable conductor solid max. 0.75 mm²
stranded wire max. 0.50 mm²

Electrical

Contact resistance ≤ 5 mΩ
Nominal current at 40°C 4 A
Nominal voltage 4 poles 240 V
5 poles 60 V
encapsulated
Rated voltage 4 poles 250 V
5 poles 63 V
Test voltage 4 poles 2.0 kV eff. / 60 s
5 poles 1.5 kV eff. / 60 s
Insulation resistance > 10⁹ Ω
Pollution degree 3

Part Number	Pins	Ventilation hole	Characteristics
RSE 4	4	-	
RSE 4 L		2.0 mm Ø	
RSE 5	5	-	
RSEQ 5		-	

M12-Receptacle Connectors In Accordance With IEC 61076-2-101

RSEL | RSELP



Male, 4-, 5-, and 8-Pole

Receptacle connector, M12 male connector for sensors, solder contacts for printed circuit board mounting.

RSEL

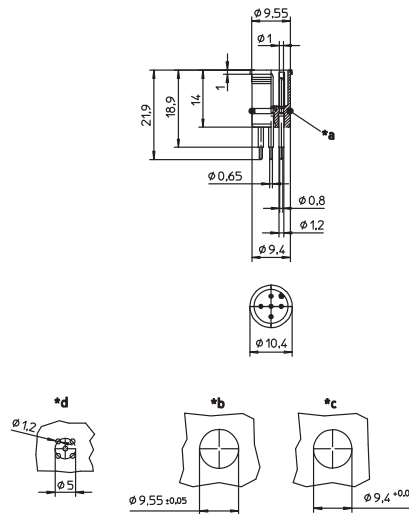

RSEL 8 POLE

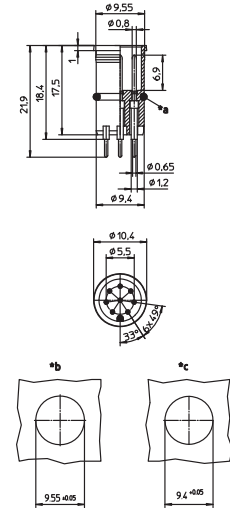

- *a O-ring enclosed separately
- *b ventilation hole
- *c cut out with O-ring
- *d cut out without O-ring



Male, 4- and 8-Pole

Receptacle connector, M12 male connector for sensors, with octagonal shape as antirotation protection, solder contacts for printed circuit board mounting.

RSELP

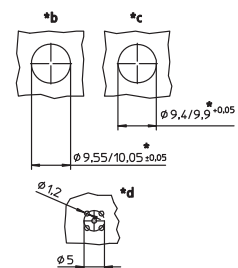
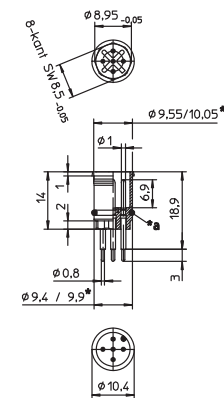

Pin Assignments

Face Views / M12, Male / Female

4 pole

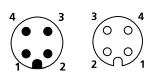

5 pole

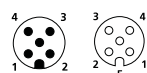

8 pole

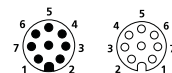



Be Certain with Belden

M12-Receptacle Connectors In Accordance With IEC 61076-2-101
RSEL | RSELP

Technical Data

Environmental

Degree of protection IP 67 / NEMA 6P
Operating temperature range -25°C (-13°F) / +80°C (+194°F)

Mechanical

Insert PA
Contact CuZn, pre-nickel and 0.8 microns gold-plated
O-ring FKM
Mode of connection printed circuit board mount

Electrical

Contact resistance $\leq 5 \text{ m}\Omega$
Nominal current at 40°C
4-5 poles 4 A
8 poles 2 A
Nominal voltage
4 poles 240 V
5 poles 60 V
8 poles 30 V
encapsulated
Rated voltage
4 poles 250 V
5 poles 63 V
8 poles 36 V
Test voltage
4 poles 2.0 kV eff. / 60 s
5-8 poles 1.5 kV eff. / 60 s
Insulation resistance $> 10^9 \Omega$
Pollution degree 3

Part Number	Pins	Characteristics
RSEL 4 RSELP 4	4	 
RSEL 5 RSELP 5	5	 
RSEL 8	8	 

1/2"-20-Receptacle Connectors, Automotive Color Code

RSF 3 U | RKF 3 U

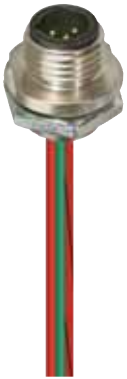

Male, 3-, 4-, and 5-Pole

1/2"-20 receptacle, dual keyway, 3-, 4-, and 5- pole, male for front mounting, dual keyway, 22 AWG, flying leads, panel mount thread 1/4-18 NPT, Automotive color code.

RSF 3 U

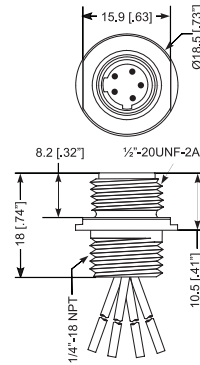

Female, 3-, 4-, and 5-Pole

1/2"-20 receptacle, dual keyway, 3-, 4-, and 5-pole, female for front mounting, dual keyway, 22 AWG, flying leads, panel mount thread 1/4-18 NPT, Automotive color code.

RKF 3 U

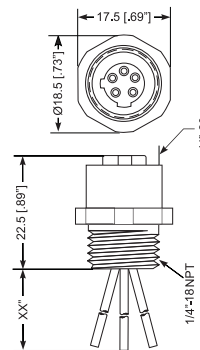

Pin Assignments

Face Views, Male / Female

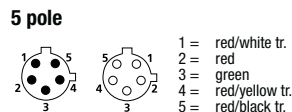
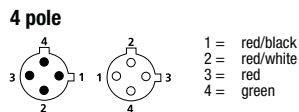
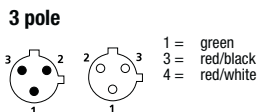



Be Certain with Belden

1/2"-20-Receptacle Connectors, Automotive Color Code
 RSF 3 U | RKF 3 U

Technical Data

Environmental

Degree of protection IP 67 / NEMA 6P
 Operating temperature range -25°C (-13°F) / +90°C (+194°F)



Mechanical

Housing CuZn, nickel plated
 Mounting 1/4" 18 NPT
 Contacts CuZn, gold over nickel plated
 Insert Nylon, black

Electrical

Current rating 4 A
 Voltage rating 250 V
 Conductor 22 AWG

Receptacles

Part Number		Pins	Characteristics
RSF 3 U/1F	RKF 3 U/1F	3	
RSF 4 U/1F	RKF 4 U/1F	4	
RSF 5 U/1F	RKF 5 U/1F	5	

1/2"-20-Receptacle-Insert Connectors

RSE 3 U | RSE 4 U | RSE 5 U



Male, 3-, 4-, and 5-Pole

1/2"-20 receptacle, dual keyway, 3-, 4-, and 5- pole, male insert.

RSE 3 U | RSE 4 U | RSE 5 U

Pin Assignments

Face Views, Male / Female

3 pole



4 pole



5 pole





Be Certain with Belden

1/2"-20-Receptacle-Insert Connectors

RSE 3 U | RSE 4 U | RSE 5 U

Technical Data

Environmental







Degree of protection IP 67 / NEMA 6P
 Operating temperature range -25°C (-13°F) / +80°C (+194°F)

Mechanical

Insert PA
 Contact CuZn, pre-nickel and 0.8 microns gold-plated
 O-ring FKM
 Mode of connection solder connection
 Connectable conductor solid max. 0.75 mm²
 stranded wire max. 0.50 mm²

Electrical

Contact resistance ≤ 5 mΩ
 Nominal current at 40°C 4 A
 Nominal voltage 3-4 poles 240 V
 5 poles 60 V encapsulated
 Rated voltage 3-4 poles 250 V
 5 poles 63 V
 Test voltage 3-4 poles 2.0 kV eff. / 60 s
 5 poles 1.5 kV eff. / 60 s
 Insulation resistance > 10⁹ Ω
 Pollution degree 3

Part Number	Pins	Characteristics
RSE 3 U	3	 
RSE 4 U	4	 
RSE 5 U	5	 

7/8" Mini-Receptacle Connectors, Front Mount, IEC Color Code

RSF.../11 | RSF.../13.5 | RKF.../11 | RKF.../13.5



Male, 2-, 3-, 4-, and 5-Pole

Receptacle connector, 7/8"-A body, male 2-, 3-, 4-, and 5-pole for front mounting, assembled stranded wire, potted with epoxy, chassis side thread PG11 or PG13.5, screw connection (panel nut RSKF 11 or RSKF 13.5).

RSF.../11

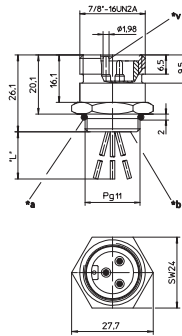

*a O-ring enclosed separately
*b solder contacts potted with epoxy
*L 0.3 m

RSF.../13.5

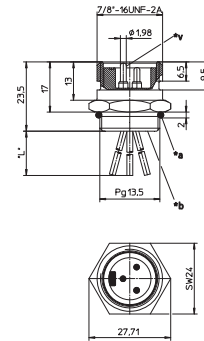

*a O-ring enclosed separately
*b solder contacts potted with epoxy
*v center contact leading
*L 0.3 m



Female, 2-, 3-, 4-, and 5-Pole

Receptacle connector, 7/8"-A body, female 2-, 3-, 4-, and 5-pole for front mounting, assembled stranded wire, potted with epoxy, chassis side thread PG11 or PG13.5, screw connection (panel nut RSKF 11 or RSKF 13.5).

RKF.../11

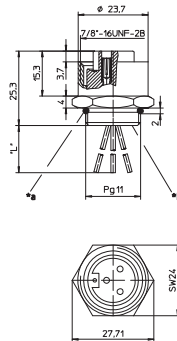

*a O-ring enclosed separately
*b solder contacts potted with epoxy
*L 0.3 m

RKF.../13.5

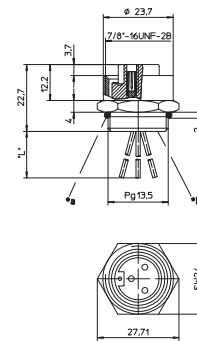

*a O-ring enclosed separately
*b solder contacts potted with epoxy
*L 0.3 m

Pin Assignments

Face Views, 7/8"-Male / Female

2 pole

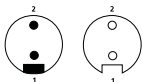

1 = brown
2 = blue

3 pole

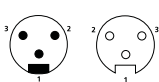

1 = brown
2 = black
3 = blue

4 pole

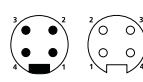

1 = brown
2 = white
3 = blue
4 = black

5 pole

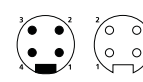

1 = black
2 = blue
3 = green/yellow
4 = brown
5 = white



Be Certain with Belden

7/8” Mini-Receptacle Connectors, Front Mount, IEC Color Code

RSF.../11 | RSF.../13.5 | RKF.../11 | RKF.../13.5

Technical Data

Environmental











Degree of protection IP 68 / NEMA 6P
 Operating temperature range -25°C (-13°F) / +90°C (+194°F)

Mechanical

Housing / Molded body CuZn, nickel-plated
 Insert TPU, self-extinguishing
 Contact CuZn, silver-plated and 0.3 microns gold-plated

Electrical

Contact resistance ≤ 5 mΩ
 Nominal current at 40°C 2–3 poles 12 A
 4–5 poles 9 A
 Nominal voltage 240 V
 Rated voltage 250 V
 Test voltage 3–4 poles 2.5 kV eff. / 60 s
 5 poles 1.5 kV eff. / 60 s
 Insulation resistance > 10⁹ Ω
 Pollution degree 3

Part Number				Pins	Lead (mm ²)	Characteristics
Male PG11	Male PG13.5	Female PG11	Female PG13.5			
RSF 20/11-03	RSF 20/13.5-03	RKF 20/11-03	RKF 20/13.5-03	2	0.75	 
RSF 30/11-01	RSF 30/13.5-01	RKF 30/11-01	RKF 30/13.5-01	3	0.75	 
RSF 30/11-05	RSF 30/13.5-05	RKF 30/11-05	RKF 30/13.5-05		0.75	 
RSF 40/11-02	RSF 40/13.5-02	RKF 40/11-02	RKF 40/13.5-02	4	0.5	 
RSF 50/11-04	RSF 50/13.5-04	RKF 50/11-04	RKF 50/13.5-04	5	0.5	 

7/8" Mini-Receptacle Connectors, Front Mount, US Color Code

RSF 20...60A | RKF 201...601A



Male, 2-, 3-, 4-, 5, and 6-Pole

Receptacle connector, 7/8"-A body, male 2-, 3-, 4-, 5, and 6-pole for front mounting, assembled stranded wire, potted with epoxy, chassis side thread 1/2" NPT, screw connection.

– US Color Code –

RSF 20...60A

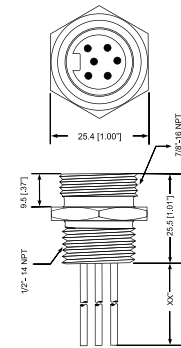

Female, 2-, 3-, 4-, 5, and 6-Pole

Receptacle connector, 7/8"-A body, female 2-, 3-, 4-, 5, and 6-pole for front mounting, assembled stranded wire, potted with epoxy, chassis side thread 1/2" NPT, screw connection.

– US Color Code –

RKF 201...601A

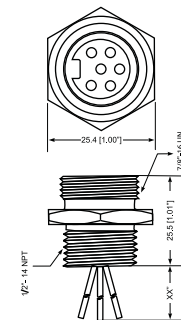

Pin Assignments

Face Views, 7/8"-Male / Female

2 pole

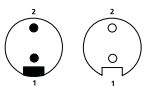

1 = white
2 = black

3 pole

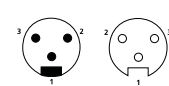

1 = green
2 = black
3 = white

4 pole

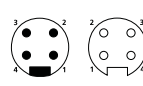

1 = black
2 = white
3 = red
4 = green

5 pole

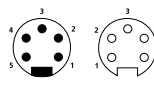

1 = white
2 = red
3 = green
4 = orange
5 = black

6 pole

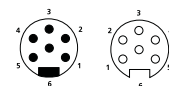

1 = white
2 = red
3 = green
4 = orange
5 = black
6 = blue



Be Certain with Belden

7/8" Mini-Receptacle Connectors, Front Mount, US Color Code
 RSF 20...60A | RKF 201...601A

Technical Data

Environmental















Degree of protection IP 68 / NEMA 6P
 Operating temperature range -40°C (-40°F) / +90°C (+194°F)

Mechanical

Insert TPU, yellow
 Contacts CuZn, gold plated
 Receptacle shell Zinc die cast (e-coated black)
 Locknut Steel, zinc plated
 O-ring Viton

Electrical

Current rating 2 pole: 12 A
 3-5 pole: 8 A
 6 pole: 5 A
 Voltage rating 2-5 pole: 600 V
 6 pole: 300 V

Part Number	Pins	Gauge	Characteristics
RSF 20-678/1F RKF 201-678/1F	2	16	  
RSF 30-638/1F RKF 301-638/1F	3	16	  
RSF 40-639/1F RKF 401-639/1F	4	16	  
RSF 50-677/1F RKF 501-677/1F	5	16	  
RSF 60A-697/1F RKF 601A-697/1F	6	18	 

7/8" Mini-Receptacle Connectors, Front Mount, Automotive Color Code

RSF 30...50 | RKF 301...501



Male, 3- and 5-Pole

Receptacle connector, 7/8"-A body, male 3- and 5-pole for front mounting, assembled stranded wire, potted with epoxy, chassis side thread 1/2" NPT, screw connection.

- Automotive Color Code -

RSF 30...50

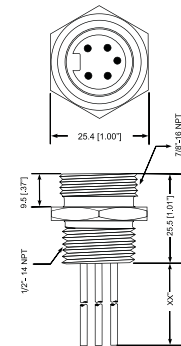

Female, 3- and 5-Pole

Receptacle connector, 7/8"-A body, female 3- and 5-pole for front mounting, assembled stranded wire, potted with epoxy, chassis side thread 1/2" NPT, screw connection.

- Automotive Color Code -

RKF 301...501

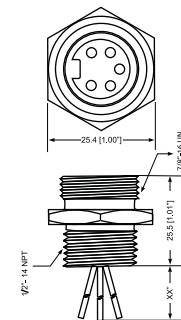

Pin Assignments

Face Views, 7/8"-Male / Female

3 pole

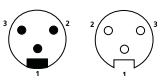

- 1 = green
- 2 = red/black
- 3 = red/white

5 pole

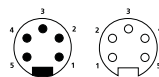

- 1 = red/white
- 2 = red
- 3 = green
- 4 = red/yellow
- 5 = red/black



Be Certain with Belden

7/8" Mini-Receptacle Connectors, Front Mount, Automotive Color Code
 RSF 30...50 | RKF 301...501

Technical Data

Environmental

Degree of protection IP 68 / NEMA 6P
 Operating temperature range -40°C (-40°F) / +90°C (+194°F)









Mechanical

Insert TPU, yellow
 Contacts CuZn, gold plated
 Receptacle shell Zinc die cast (e-coated black)
 Locknut Steel, zinc plated
 O-ring Viton

Electrical

641 and 642
 Current rating 8 A
 Voltage rating 600 V

690
 Current rating 5.6 A
 Voltage rating 300 V

Part Number	Pins	Gauge	Characteristics
RSF 30-641/1F RKF 301-641/1F	3	16	  
RSF 50-642/1F RKF 501-642/1F	5	16	  
RSF 50-690/1F RKF 501-690/1F	5	18	  

7/8" Mini-Receptacle Connectors, Front Mount, IEC Color Code

RSF 20...50 | RKF 20...50



Male, 2-, 3-, 4-, and 5-Pole

Receptacle connector, 7/8"-A body, male 2-, 3-, 4-, and 5-pole for front mounting, assembled stranded wire, potted with epoxy, chassis side thread 1/2" NPT, screw connection.

- IEC Color Code -

RSF 20...50

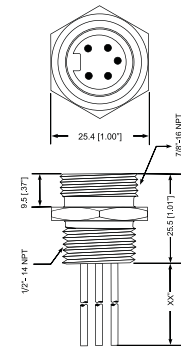

Female, 2-, 3-, 4-, and 5-Pole

Receptacle connector, 7/8"-A body, female 2-, 3-, 4-, and 5-pole for front mounting, assembled stranded wire, potted with epoxy, chassis side thread 1/2" NPT, screw connection.

- IEC Color Code -

RKF 201...501

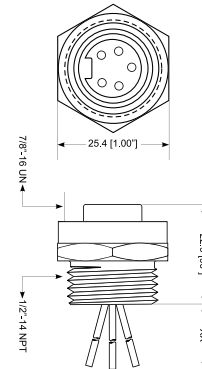

Pin Assignments

Face Views, 7/8"-Male / Female

2 pole

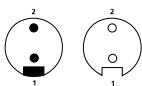

1 = brown
2 = blue

3 pole

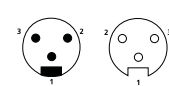

1 = black
2 = brown
3 = blue

4 pole

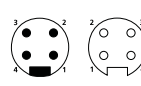

1 = black
2 = blue
3 = brown
4 = white

5 pole

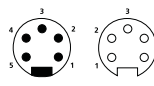

1 = black
2 = blue
3 = yellow/green tr.
4 = brown
5 = white



Be Certain with Belden

7/8" Mini-Receptacle Connectors, Front Mount, IEC Color Code
 RSF 20...50 | RKF 20...50

Technical Data

Environmental

Degree of protection IP 68 / NEMA 6P
 Operating temperature range -40°C (-40°F) / +90°C (+194°F)

Mechanical

Molded body TPU, yellow
 Contacts CuZn, gold plated
 Receptacle shell RSF: Zinc die cast (e-coated black)
 RKF: Aluminum (clear anodized)
 Locknut Steel, zinc plated
 O-ring Viton

Electrical

Current rating 2 pole: 12 A
 3 pole: 8 A
 4 and 5 pole: 5.6 A
 Voltage Rating 300 V

Part Number	Pins	Gauge	Characteristics
RSF 20-603/0.3 M RKF 20-603/0.3 M	2	18	
RSF 30-695/0.3 M RKF 30-695/0.3 M	3	18	
RSF 40-693/0.3 M RKF 40-693/0.3 M	4	18	
RSF 50-694/0.3 M RKF 50-694/0.3 M	5	18	

7/8" Mini-Receptacle Connectors, Front Mount, EURO AC Color Code

RSF 30 | RKF 30



Male, 3-Pole

Receptacle connector, 7/8"-A body, male 3-pole for front mounting, assembled stranded wire, potted with epoxy, chassis side thread 1/2" NPT, screw connection.

- EURO AC Color Code -

RSF 30

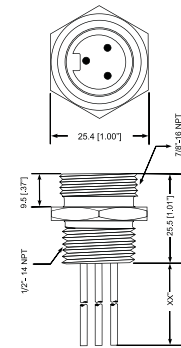

Female, 3-Pole

Receptacle connector, 7/8"-A body, female 3-pole for front mounting, assembled stranded wire, potted with epoxy, chassis side thread 1/2" NPT, screw connection.

- EURO AC Color Code -

RKF 30

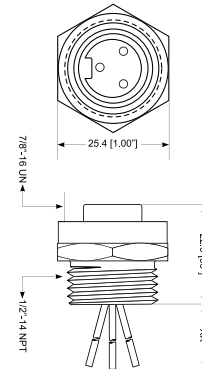

Pin Assignments

Face Views, 7/8"-Male / Female

3 pole

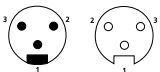

- 1 = yellow/green
- 2 = brown
- 3 = blue



Be Certain with Belden

7/8" Mini-Receptacle Connectors, Front Mount, EURO AC Color Code
 RSF 30 | RKF 30

Technical Data

Environmental

Degree of protection IP 68 / NEMA 6P
 Operating temperature range -40°C (-40°F) / +90°C (+194°F)

Mechanical

Insert TPU, yellow
 Contacts CuZn, gold plated
 Receptacle shell RSF: Zinc die cast (e-coated black)
 RKF: Aluminum (clear anodized)
 Locknut Steel, zinc plated
 O-ring Viton

Electrical

Current rating 8 A
 Voltage rating 300 V

Receptacles

Part Number	Pins	Gauge	Characteristics
RSF 30-601/0.3M RKF 30-601/0.3M	3	18	  

1" Mini-Receptacle Connectors, Front Mount, US Color Code

RSF 60B...80M | RKF 601B...801M



Male, 6-, 7-, and 8-Pole

Receptacle connector, 1"-B body, male 6-, 7-, and 8-pole for front mounting, assembled stranded wire, potted with epoxy, chassis side thread 1/2" NPT, screw connection.

- US Color Code -

RSF 60B...80M

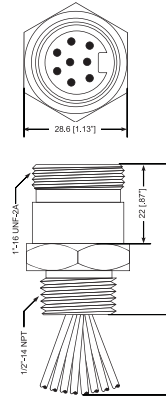

Female, 6-, 7-, and 8-Pole

Receptacle connector, 1"-B body, female 6-, 7-, and 8-pole for front mounting, assembled stranded wire, potted with epoxy, chassis side thread 1/2" NPT, screw connection.

- US Color Code -

RKF 601B...801M

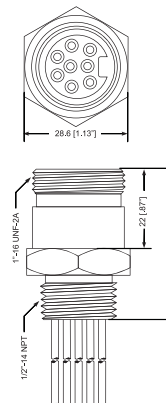

Pin Assignments

Face Views, 1"-Male / Female

6 pole

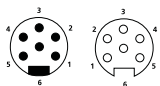

- 1 = orange
- 2 = blue
- 3 = black
- 4 = white
- 5 = red
- 6 = green

7 pole

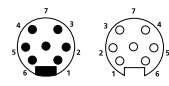

- 1 = white/black
- 2 = black
- 3 = white
- 4 = red
- 5 = orange
- 6 = blue
- 7 = green

8 pole

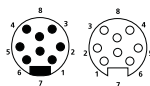

- 1 = orange
- 2 = blue
- 3 = white/black
- 4 = black
- 5 = white
- 6 = red
- 7 = green
- 8 = red/black



Be Certain with Belden

1" Mini-Receptacle Connectors, Front Mount, US Color Code
 RSF 60B...80M | RKF 601B...801M

Technical Data

Environmental

Degree of protection IP 68 / NEMA 6P
 Operating temperature range -40°C (-40°F) / +90°C (+194°F)







Mechanical

Insert TPU, yellow
 Contacts CuZn, gold plated
 Receptacle shell Aluminum (anodized, clear)
 Locknut Steel, zinc plated
 O-ring Viton

Electrical

Current rating 6 and 7 pole: 8 A
 8 pole: 7 A
 Voltage rating 600 V

Receptacles

Part Number	Pins	Gauge	Characteristics
RSF 60B-696/1F RKF 601B-696/1F	6	16	 
RSF 70M-622/1F RKF 701M-622/1F	7	16	 
RSF 80M-698/1F RKF 801M-698/1F	8	16	 

1 1/8" Mini-Receptacle Connectors, Front Mount, US Color Code

RSF 90M...120M | RKF 901M...1201M



Male, 9-, 10-, and 12-Pole

Receptacle connector, 1 1/8"-c body, male 9-, 10-, and 12-pole for front mounting, assembled stranded wire, potted with epoxy, chassis side thread 1/2" NPT, screw connection.

- US Color Code -

RSF 90M...120M

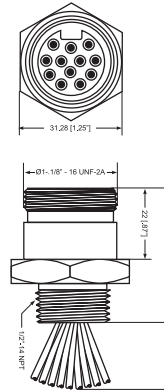

Female, 9-, 10-, and 12-Pole

Receptacle connector, 1 1/8"-c body, female 9-, 10-, and 12-pole for front mounting, assembled stranded wire, potted with epoxy, chassis side thread 1/2" NPT, screw connection.

- US Color Code -

RKF 901M...1201M

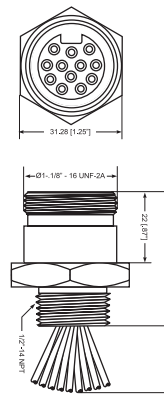

Pin Assignments

Face Views, 1 1/8"-Male / Female

9 pole

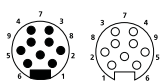

- 1 = orange
- 2 = blue
- 3 = red/black
- 4 = green/black
- 5 = white
- 6 = red
- 7 = green
- 8 = white/black
- 9 = white

10 pole

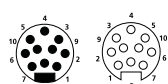

- 1 = orange
- 2 = blue
- 3 = white/black
- 4 = red/black
- 5 = green/black
- 6 = orange/black
- 7 = red
- 8 = green
- 9 = black
- 10 = white

12 pole

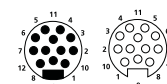

- 1 = orange
- 2 = blue
- 3 = white/black
- 4 = red/black
- 5 = green/black
- 6 = orange/black
- 7 = blue/black
- 8 = black/white
- 9 = green
- 10 = red
- 11 = white
- 12 = black



Be Certain with Belden

1 1/8" Mini-Receptacle Connectors, Front Mount, US Color Code
 RSF 90M...120M | RKF 901M...1201M

Technical Data

Environmental









Degree of protection IP 68 / NEMA 6P
 Operating temperature range -40°C (-40°F) / +90°C (+194°F)

Mechanical

Insert TPU, yellow
 Contacts CuZn, gold plated
 Receptacle shell Aluminum (anodized, clear)
 Locknut Steel, zinc plated
 O-ring Viton

Electrical

Current rating 9 and 10 pole: 7 A
 12 pole: 5 A
 Voltage rating 600 V

Part Number	Pins	Gauge	Characteristics
RSF 90M-623/1F RKF 901M-623/1F	9	16	  
RSF 100M-699/1F RKF 1001M-699/1F	10	16	  
RSF 120M-624/1F RKF 1201M-624/1F	12	16	  

1 1/8" Mini-Receptacle Connectors, Front Mount, IEC Color Code

RSF 120M | RKF 1201M



Male, 11/12-Pole

Receptacle connector, 1 1/8"-c body, male 12-pole for front mounting, assembled stranded wire, potted with epoxy, chassis side thread 1/2" NPT, screw connection.

- IEC Color Code -

RSF 120M

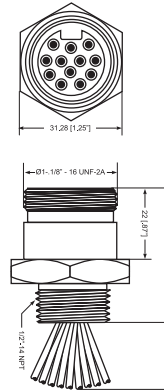

Female, 11/12-Pole

Receptacle connector, 1 1/8"-c body, female 12-pole for front mounting, assembled stranded wire, potted with epoxy, chassis side thread 1/2" NPT, screw connection.

- IEC Color Code -

RKF 1201M

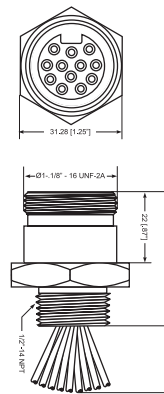

Pin Assignments

Face Views, 1 1/8"-Male / Female

12 pole

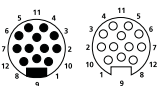

- 1 = black
- 2 = red
- 3 = pink
- 4 = grey
- 5 = yellow
- 6 = green
- 7 = white
- 8 = violet
- 9 = green/yellow
- 10 = blue
- 11 = n.c.
- 12 = brown



Be Certain with Belden

1 1/8" Mini-Receptacle Connectors, Front Mount, IEC Color Code
 RSF 120M | RKF 1201M

Technical Data

Environmental

Degree of protection IP 68 / NEMA 6P
 Operating temperature range -40°C (-40°F) / +90°C (+194°F)



Mechanical

Insert TPU, yellow
 Contacts CuZn, gold plated
 Receptacle shell Aluminum (anodized, clear)
 Locknut Steel, zinc plated
 O-ring Viton

Electrical

Current rating Pin 9: ground
 10 and 12: 12 A
 All other: 4 A
 Voltage rating 600 V

Receptacles

Part Number	Pins	Gauge	Characteristics
RSF 120M-630/0.3M RKF 1201M-630/0.3M	12	18	  

1 1/8" Mini-Receptacle Connectors, Front Mount, Numeric Color Code

RSF 120M...190M | RKF 1201M...1901M



Male, 12- and 19-Pole

Receptacle connector, 1 1/8"-c body, male 12- and 19-pole for front mounting, assembled stranded wire, potted with epoxy, chassis side thread 1/2" NPT, screw connection.

- Numeric Color Code -

RSF 120M...190M

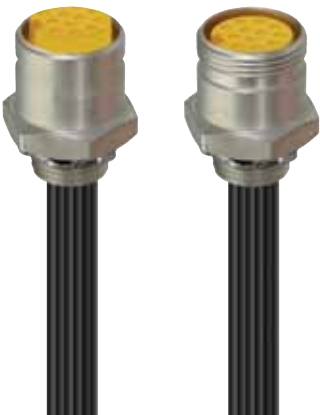
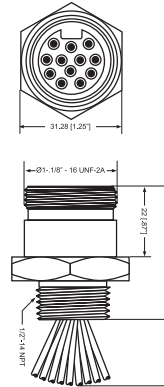

Female, 12- and 19-Pole

Receptacle connector, 1 1/8"-c body, female 12- and 19-pole for front mounting, assembled stranded wire, potted with epoxy, chassis side thread 1/2" NPT, screw connection.

- Internal Threads: RKF 120M-676/1F

- External Threads: RKF 1201M-676/1F

RKF 120M | RKF 1201M...1901M

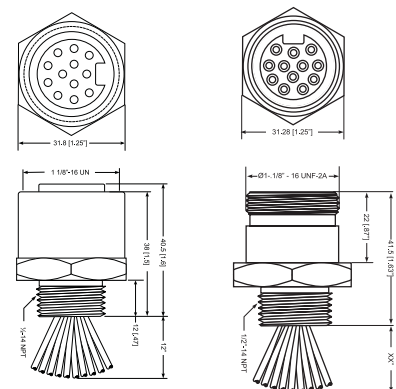

Pin Assignments

Face Views, 1 1/8"-Male / Female

12 pole

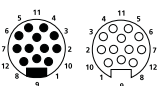

- 1 = black #1
- 2 = black #2
- 3 = black #3
- 4 = black #4
- 5 = black #5
- 6 = black #6
- 7 = black #7
- 8 = black #8
- 9 = green/yellow
- 10 = black #10
- 11 = black #11
- 12 = black #12

19 pole

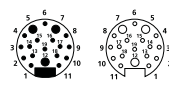

- 1 = black #1
- 2 = black #2
- 3 = black #3
- 4 = black #4
- 5 = black #5
- 6 = black #6
- 7 = black #7
- 8 = black #8
- 9 = black #9
- 10 = black #10
- 11 = black #11
- 12 = green/yellow
- 13 = black #13
- 14 = black #14
- 15 = black #15
- 16 = black #16
- 17 = black #17
- 18 = black #18
- 19 = black #19



Be Certain with Belden

1 1/8" Mini-Receptacle Connectors, Front Mount, Numeric Color Code
 RSF 120M...190M | RKF 1201M...1901M

Technical Data

Environmental

Degree of protection IP 68 / NEMA 6P
 Operating temperature range -40°C (-40°F) / +90°C (+194°F)

Mechanical

Insert TPU, yellow
 Contacts CuZn, gold plated
 Receptacle shell Aluminum (anodized, clear)
 Locknut Steel, zinc plated
 O-ring Viton

Electrical

Current rating
 12 pole: 9 = ground
 10 and 12: 12 A
 All other: 4 A
 19 pole: 12 = ground
 5 and 7 = 8 A
 All other: 3 A
 Voltage rating 300 V

Receptacles

Part Number			Pins	Gauge	Characteristics
Male External Threads	Female External Threads	Female Internal Threads			
RSF 120M-676/1F	RKF 1201M-676/1F	RKF 120M-676/1F	12	18	
RSF 190M-669/1F	RKF 1901M-669/1F	RKF 190M-669/1F	19	18	

M8 Field Attachable Connectors

RSMC | RKMC



Male, 3- and 4-Pole

Field attachable connector, M8 male connector 3- and 4-pole with threaded joint, assembling with solder connections.



Female, 3- and 4-Pole

Field attachable connector, M8 Female connector 3- and 4-pole with threaded joint, assembling with solder connections.

RSMC

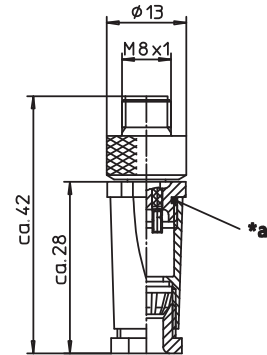

*a O-Ring

RKMC

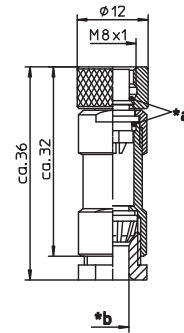

*a O-Ring
*b Screw joint for cable

Pin Assignments

Face Views / M12, Male / Female

3 pole

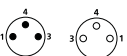

4 pole

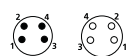



Be Certain with Belden

M8 Field Attachable Connectors

RSMC | RKMC

Technical Data

Environmental

Degree of protection IP 67 / NEMA 6P
 Operating temperature range RSMC: -25°C (-13°F) / +80°C (+176°F)
 RKMC: -40°C (-40°F) / +85°C (+185°F)

Mechanical

Housing / Molded body RSMC: CuZn, nickel-plated
 RKMC: PBT
 Insert PA
 Contact RSMC: CuZn, pre-nickeled and
 0.8 microns gold-plated
 RKMC: CuSn, gold-plated
 Receptacle shell CuZn, nickel-plated
 O-ring FKM (only RKMC)
 Mode of connection Solder connection
 Connectable conductor RSMC: max. 0.34mm²
 RKMC: max. 0.25 mm²

Electrical

Contact resistance ≤ 5 mΩ
 Nominal current at 40°C 4 A
 Nominal voltage 3 poles 60 V
 4 poles 30 V
 Rated voltage 3 poles 63 V
 4 poles 36 V
 Test voltage RSMC:
 3 poles 1.5 kV eff. / 60 s
 4 poles 0.8 kV eff. / 60 s
 Insulation resistance > 10⁹ Ω
 Pollution degree 3

Part Number	Pins	Cable Diameter Range	Characteristics
Male	Female		
RSMC 3	RKMC 3	3	Ø 3.5-5.0 mm
RSMC 4	RKMC 4	4	Ø 3.5-5.0 mm



M8 Field Attachable Connectors

RSMCW | RKM CW



Male, 3- and 4-Pole

Field attachable connector, M8 male right angle connector, 3- and 4-pole with threaded joint, assembling with solder connections.

RSMCW

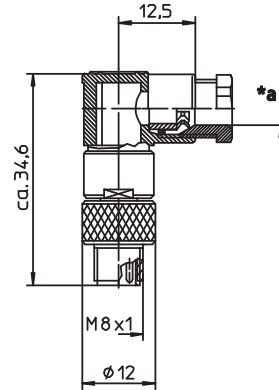

*a O-Ring
*b Screw joint for cable



Female, 3- and 4-Pole

Field attachable connector, M8 female right angle connector 3- and 4-pole with threaded joint, assembling with solder connections.

RKM CW

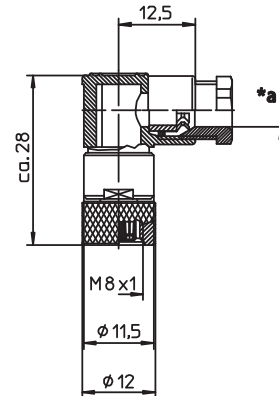

*a O-Ring
*b Screw joint for cable

Pin Assignments

Face Views / M12, Male / Female

3 pole

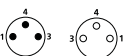

4 pole

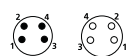



Be Certain with Belden

M8 Field Attachable Connectors

RSMCW | RKMCW

Technical Data

Environmental

Degree of protection IP 67 / NEMA 6P
 Operating temperature range -40°C (-40°F) / +85°C (+185°F)

Mechanical

Housing / Molded body PBT
 Insert PA
 Contact CuSn, gold-plated
 Receptacle shell CuZn, nickel-plated
 O-ring FKM (only RKMCW)
 Mode of connection Solder connection
 Connectable conductor max. 0.25 mm²

Electrical

Contact resistance ≤ 5 mΩ
 Nominal current at 40°C 4 A
 Nominal voltage 3 poles 60 V
 4 poles 30 V
 Rated voltage 3 poles 63 V
 4 poles 36 V
 Test voltage 0.9 kV eff. / 60 s
 Insulation resistance > 10⁹ Ω
 Pollution degree 3

Part Number	Pins	Cable Diameter Range	Characteristics
Male	Female		
RSMCW 3	RKMCW 3	3	Ø 3.5-5.0 mm
RSMCW 4	RKMCW 4	4	Ø 3.5-5.0 mm



Field Attachable Connectors

M8 Field Attachable Connectors

RSMCK | RKMCK



Male, 3- and 4-Pole

Field attachable connector, M8 male connector, 3- and 4-pole with threaded joint, assembling with screw terminals.

RSMCK

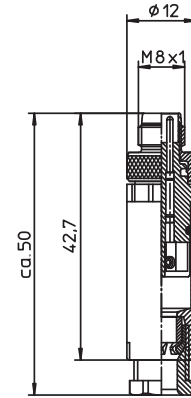

Female, 3- and 4-Pole

Field attachable connector, M8 female connector 3- and 4-pole with threaded joint, assembling with screw terminals.

RKMCK

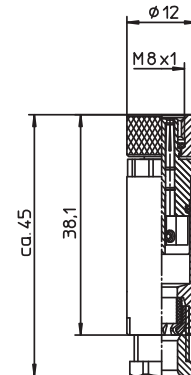

Pin Assignments

Face Views / M12, Male / Female

3 pole

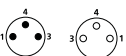

4 pole

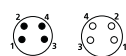



Be Certain with Belden

M8 Field Attachable Connectors

RSMCK | RKMCK

Technical Data

Environmental

Degree of protection IP 67 / NEMA 6P
 Operating temperature range -40°C (-40°F) / +85°C (+185°F)

Mechanical

Housing / Molded body PA
 Insert TPU, self-extinguishing
 Contact CuZn, pre-nickel and 0.8 microns gold-plated
 Receptacle shell CuZn, nickel-plated
 O-ring FKM
 Mode of connection Screw terminals
 Connectable conductor 0.14-0.50 mm²

Electrical

Contact resistance ≤ 5 mΩ
 Nominal current at 40°C 4 A
 Nominal voltage 3 poles 60 V
 4 poles 30 V
 Rated voltage 3 poles 63 V
 4 poles 36 V
 Test voltage 3 poles 1.5 kV eff. / 60 s
 4 poles 0.8 kV eff. / 60 s
 Insulation resistance > 10⁹ Ω
 Pollution degree 3

Part Number	Pins	Cable Diameter Range	Characteristics
Male	Female		
RSMCK 3	RKMCK 3	3	Ø 3.5-5.0 mm
RSMCK 4	RKMCK 4	4	Ø 3.5-5.0 mm



M12 Field Attachable Connectors

RSC | RKC



Male, 3-, 4-, 5-, and 8-Pole

Field attachable connector, M12 male connector, 3-, 4-, 5-, and 8-pole with threaded joint, assembling with screw terminals.

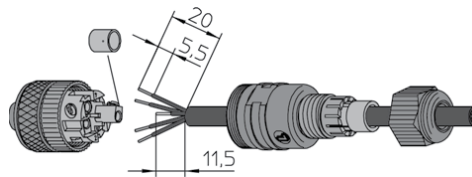

RSC

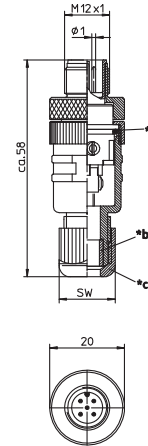

*a O-Ring
*b gasket
*c cap nut



Female, 3-, 4-, 5-, and 8-Pole

Field attachable connector, M12 female connector, 3-, 4-, 5-, and 8-pole with threaded joint, assembling with screw terminals.

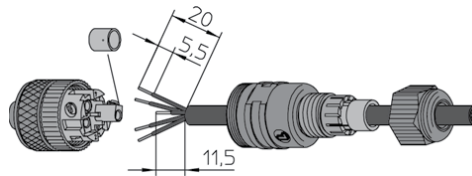

RKC

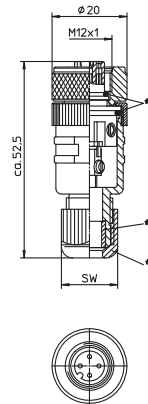

*a O-Ring
*b gasket
*c cap nut

Pin Assignments

Face Views / M12, Male / Female

3 pole

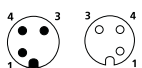

4 pole



5 pole

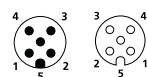

8 pole

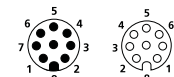



Be Certain with Belden

M12 Field Attachable Connectors

RSC | RKC

Technical Data

Environmental













Degree of protection IP 67 / NEMA 6P
 Operating temperature range -25°C (-13°F) / +90°C (+194°F)

Mechanical

Housing / Molded body PBT
 Insert PBT
 Contact CuZn, pre-coppered, CuSnZn
 8-poles pre-nickelated, gold-plated
 Receptacle shell CuZn, nickel-plated
 O-ring FKM
 Mode of connection Screw terminals
 Connectable conductor 3-5 poles max. 0.75 mm²
 8 poles max. 0.50 mm²

Electrical

Contact resistance ≤ 5 mΩ
 Nominal current at 40°C 3-5 poles 4 A
 8 poles 2 A
 Nominal voltage 3-4 poles 240 V
 5 poles 60 V
 8 poles 30 V
 Rated voltage 3-4 poles 250 V
 5 poles 63 V
 8 poles 36 V
 Test voltage 3-4 poles 2.0 kV eff. / 60 s
 5 poles 1.5 kV eff. / 60 s
 8 poles 0.9 kV eff. / 60 s
 Insulation resistance > 10⁹ Ω
 Pollution degree 3

Part Number		Pins	Cable Diameter Range	Characteristics
Male	Female			
RSC 3/7	RKC 4/3/7	3	Ø 3.0-6.5 mm /SW 15	 
RSC 3/9	RKC 4/3/9		Ø 4.0-8.0 mm /SW 19	 
RSC 4/7	RKC 4/7	4	Ø 3.0-6.5 mm /SW 15	 
RSC 4/9	RKC 4/9		Ø 4.0-8.0 mm /SW 19	 
RSC 5/7	RKC 5/7	5	Ø 3.0-6.5 mm /SW 15	 
RSC 5/9	RKC 5/9		Ø 4.0-8.0 mm /SW 19	 
RSC 8/9	RKC 8/9	8	Ø 4.0-8.0 mm /SW 19	

M12 Field Attachable Connectors

RSCW | RKCW



Male, 3-, 4-, 5-, and 8-Pole (90°)

Field attachable connector, M12 male right angle connector, 3-, 4-, 5-, and 8-pole with threaded joint, assembling with screw terminals.

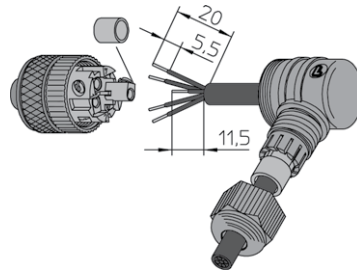

RSCW

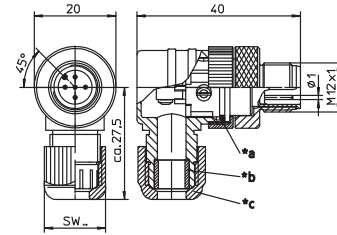

*a O-Ring
 *b gasket
 *c cap nut



Female, 3-, 4-, 5-, and 8-Pole (90°)

Field attachable connector, M12 female right angle connector, 3-, 4-, 5-, and 8-pole with threaded joint, assembling with screw terminals.

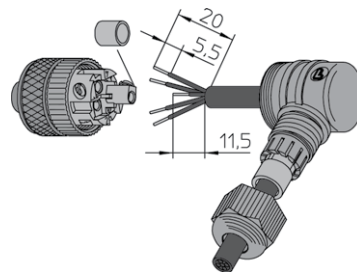

RKCW

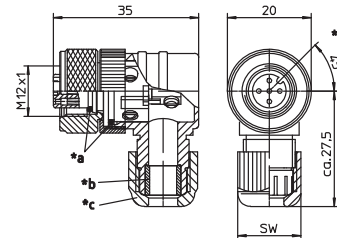

*a O-Ring
 *b gasket
 *c cap nut
 *d insert 90° rotatable

Pin Assignments

Face Views / M12, Male / Female

3 pole

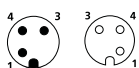

4 pole

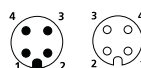

5 pole

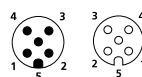

8 pole

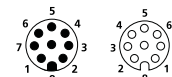



Be Certain with Belden

M12 Field Attachable Connectors

RSCW | RKCW

Technical Data

Environmental













Degree of protection IP 67 / NEMA 6P
 Operating temperature range -25°C (-13°F) / +90°C (+194°F)

Mechanical

Housing / Molded body PBT
 Insert PBT
 Contact CuZn, pre-coppered, CuSnZn
 8-poles pre-nickel-plated, gold-plated
 Receptacle shell CuZn, nickel-plated
 O-ring FKM
 Mode of connection Screw terminals
 Connectable conductor 3-5 poles max. 0.75 mm²
 8 poles max. 0.50 mm²

Electrical

Contact resistance ≤ 5 mΩ
 Nominal current at 40°C 3-5 poles 4 A
 8 poles 2 A
 Nominal voltage 3-4 poles 240 V
 5 poles 60 V
 8 poles 30 V
 Rated voltage 3-4 poles 250 V
 5 poles 63 V
 8 poles 36 V
 Test voltage 3-4 poles 2.0 kV eff. / 60 s
 5 poles 1.5 kV eff. / 60 s
 8 poles 0.9 kV eff. / 60 s
 Insulation resistance > 10⁹ Ω
 Pollution degree 3

Part Number		Pins	Cable Diameter Range	Characteristics
Male	Female			
RSCW 3/7	RKCW 4/3/7	3	Ø 3.0-6.5 mm /SW 15	 
RSCW 3/9	RKCW 4/3/9		Ø 4.0-8.0 mm /SW 19	 
RSCW 4/7	RKCW 4/7	4	Ø 3.0-6.5 mm /SW 15	 
RSCW 4/9	RKCW 4/9		Ø 4.0-8.0 mm /SW 19	 
RSCW 5/7	RKCW 5/7	5	Ø 3.0-6.5 mm /SW 15	 
RSCW 5/9	RKCW 5/9		Ø 4.0-8.0 mm /SW 19	 
RSCW 8/9	RKCW 8/9	8	Ø 4.0-8.0 mm /SW 19	

M12 Field Attachable Connectors

RKC/LED | RKCW/LED



Female, 4-Pole (LED)

Field attachable connector, M12 female connector, 4-pole with threaded joint and LED operation and function indicator, assembling with screw terminals (printed circuit board included).

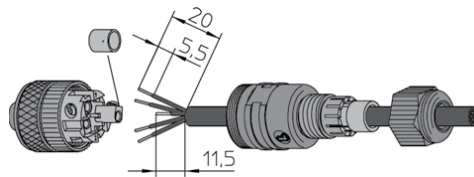

RKC/LED

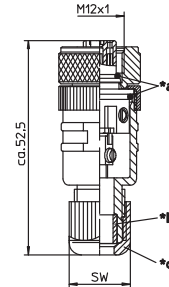

*a O-Ring
*b gasket
*c cap nut



Female, 4-Pole (90°, LED)

Field attachable connector, M12 female connector, 4-pole with threaded joint and LED operation and function indicator, assembling with screw terminals (printed circuit board included).

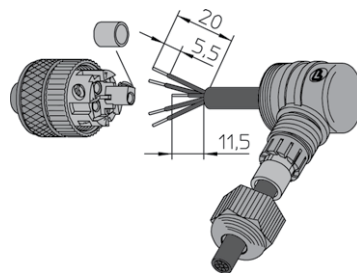

RKCW/LED

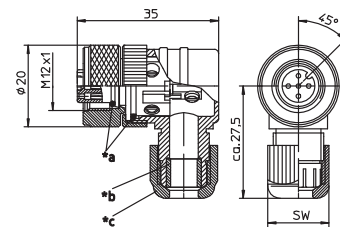

*a O-Ring
*b gasket
*c cap nut

Pin Assignments

Face Views / M12, Male / Female

4 pole

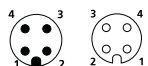



Be Certain with Belden

M12 Field Attachable Connectors

RKC/LED | RKCW/LED

Technical Data

Environmental





Degree of protection IP 67 / NEMA 6P
 Operating temperature range -25°C (-13°F) / +90°C (+194°F)

Mechanical

Housing / Molded body PBT
 Insert PBT
 Contact CuZn, pre-coppered, CuSnZn
 Receptacle shell CuZn, nickel-plated
 O-ring FKM
 Mode of connection Screw terminals
 Connectable conductor max. 0.75 mm²

Electrical

Contact resistance ≤ 5 mΩ
 Nominal current at 40°C 4 A
 Nominal voltage 10–30 V
 Rated voltage 32 V
 Insulation resistance > 10⁹ Ω
 Pollution degree 3

Part Number		Pins	Cable Diameter Range	Characteristics
Female	Female 90°			
RKC/LED 4/7	RKCW/LED 4/7	4	Ø 3.0-6.5 mm /SW 15	 
RKC/LED 4/9	RKCW/LED 4/9		Ø 4.0-8.0 mm /SW 19	 

M12 Field Attachable Connectors

RSCQ | RKCQ



Male, 3- and 4-Pole

Field attachable connector, M12 male straight connector, 3- and 4-pole with threaded joint, assembling with spring-type terminals.

RSCQ

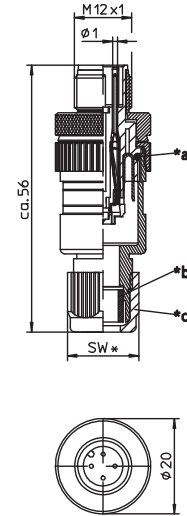

*a O-Ring
*b gasket
*c cap nut



Female, 3- and 4-Pole

Field attachable connector, M12 female straight connector, 3- and 4-pole with threaded joint, assembling with spring-type terminals.

RKCQ

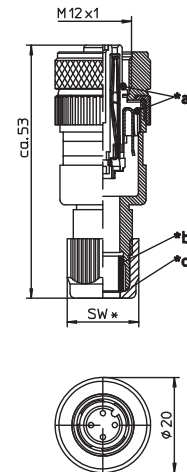

*a O-Ring
*b gasket
*c cap nut

Pin Assignments

Face Views / M12, Male / Female

3 pole

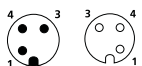

4 pole

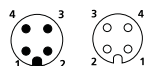



Be Certain with Belden

M12 Field Attachable Connectors

RSCQ | RKCQ

Technical Data

Environmental





Degree of protection IP 67 / NEMA 6P
 Operating temperature range -25°C (-13°F) / +90°C (+194°F)

Mechanical

Housing / Molded body PBT
 Insert PBT
 Contact stainless steel, silver-plated, gold-plated
 Receptacle shell CuZn, nickel-plated
 O-ring FKM
 Mode of connection Spring-type terminals
 Connectable conductor 0.14–0.50 mm²
 0.14 mm² with terminal pin sleeve

Electrical

Contact resistance ≤ 5 mΩ
 Nominal current at 40°C 4 A
 Nominal voltage 240 V
 Rated voltage 250 V
 Test voltage 2.0 kV eff. / 60 s
 Insulation resistance > 10⁹ Ω
 Pollution degree 3

Part Number		Pins	Cable Diameter Range	Characteristics
Male	Female			
RSCQ 3/7	RKCQ 4/3/7	3	Ø 3.0-6.5 mm /SW 15	
RSCQ 3/9	RKCQ 4/3/9		Ø 4.0-8.0 mm /SW 19	
RSCQ 4/7	RKCQ 4/7	4	Ø 3.0-6.5 mm /SW 15	
RSCQ 4/9	RKCQ 4/9		Ø 4.0-8.0 mm /SW 19	

M12 Field Attachable Connectors (Stainless Steel Hardware)

RSCN | RKC



Male, 4-, 5-, and 8-Pole

Field attachable connector, M12 male connector, 4-, 5-, and 8-pole with stainless steel hexagon threaded joint, assembling with screw terminals.

– especially designed for use in food processing equipment –

RSCN

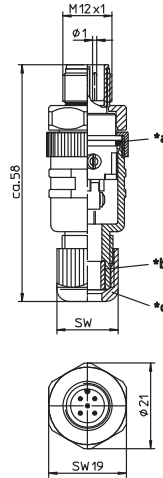

*a O-Ring
*b gasket
*c cap nut



Female, 4-, 5-, and 8-Pole

Field attachable connector, M12 female connector, 4-, 5-, and 8-pole with stainless steel hexagon threaded joint, assembling with screw terminals.

– especially designed for use in food processing equipment –

RKC

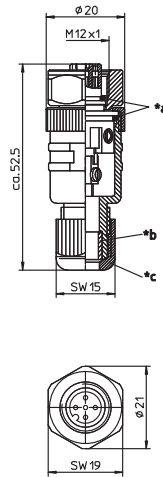

*a O-Ring
*b gasket
*c cap nut

Pin Assignments

Face Views / M12, Male / Female

4 pole

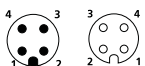

5 pole

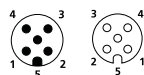

8 pole

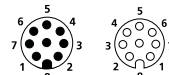



Be Certain with Belden

M12 Field Attachable Connectors (Stainless Steel Hardware)

RSCN | RKCNC

Technical Data

Environmental

Degree of protection IP 67 / NEMA 6P
 Operating temperature range -25°C (-13°F) / +85°C (+185°F)

Mechanical

Housing / Molded body PBT
 Insert PBT
 Contact CuZn, pre-coppered, CuSnZn
 8-poles pre-nickeled, gold-plated
 Receptacle shell stainless steel
 O-ring FKM
 Mode of connection Screw terminals
 Connectable conductor 4-5 poles max. 0.75 mm²
 8 poles max. 0.50 mm²

Electrical

Contact resistance ≤ 5 mΩ
 Nominal current at 40°C 4-5 poles 4 A
 8 poles 2 A
 Nominal voltage 4 poles 240 V
 5 poles 60 V
 8 poles 30 V
 Rated voltage 4 poles 250 V
 5 poles 63 V
 8 poles 36 V
 Test voltage 4 poles 2.0 kV eff. / 60 s
 5 poles 1.5 kV eff. / 60 s
 8 poles 0.9 kV eff. / 60 s
 Insulation resistance > 109 Ω
 Pollution degree 3

Part Number	Pins	Cable Diameter Range	Characteristics
Male	Female		
RSCN 4/7	RKCNC 4/7	4	Ø 3.0-6.5 mm /SW 15
RSCN 4/9	RKCNC 4/9		Ø 4.0-8.0 mm /SW 19
RSCN 5/7	RKCNC 5/7	5	Ø 3.0-6.5 mm /SW 15
RSCN 5/9	RKCNC 5/9		Ø 4.0-8.0 mm /SW 19
RSCN 8/9	RKCNC 8/9	8	Ø 4.0-8.0 mm /SW 19



Field Attachable Connectors

M12 Field Attachable Connectors (Stainless Steel Hardware)

RSCWN | RKCWN



Male, 4- and 5-Pole (90°)

Field attachable connector, M12 male right angle connector, 4- and 5-pole with stainless steel hexagon threaded joint, assembling with screw terminals.

– especially designed for use in food processing equipment –

RSCWN

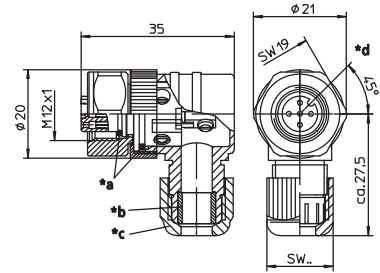

- *a O-Ring
- *b gasket
- *c cap nut
- *d insert 90° rotatable



Female, 4- and 5-Pole

Field attachable connector, M12 female right angle connector, 4- and 5-pole with stainless steel hexagon threaded joint, assembling with screw terminals.

– especially designed for use in food processing equipment –

RKCWN

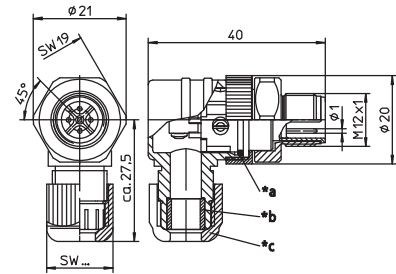

- *a O-Ring
- *b gasket
- *c cap nut

Pin Assignments

Face Views / M12, Male / Female

4 pole

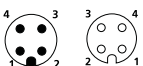

5 pole

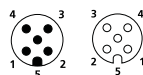



Be Certain with Belden

M12 Field Attachable Connectors (Stainless Steel Hardware) RSCWN | RKCWN

Technical Data

Environmental

Degree of protection IP 67 / NEMA 6P
 Operating temperature range -25°C (-13°F) / +85°C (+185°F)

Mechanical

Housing / Molded body PBT
 Insert PBT
 Contact CuZn, pre-coppered, CuSnZn
 8-poles pre-nickeled, gold-plated
 Receptacle shell stainless steel
 O-ring FKM
 Mode of connection Screw terminals
 Connectable conductor 4-5 poles max. 0.75 mm²
 8 poles max. 0.50 mm²

Electrical

Contact resistance ≤ 5 mΩ
 Nominal current at 40°C 4-5 poles 4 A
 8 poles 2 A
 Nominal voltage 4 poles 240 V
 5 poles 60 V
 8 poles 30 V
 Rated voltage 4 poles 250 V
 5 poles 63 V
 8 poles 36 V
 Test voltage 4 poles 2.0 kV eff. / 60 s
 5 poles 1.5 kV eff. / 60 s
 8 poles 0.9 kV eff. / 60 s
 Insulation resistance > 109 Ω
 Pollution degree 3

Part Number	Pins	Cable Diameter Range	Characteristics
Male	Female		
RSCWN 4/7	RKCWN 4/7	4	Ø 3.0-6.5 mm /SW 15
RSCWN 4/9	RKCWN 4/9		Ø 4.0-8.0 mm /SW 19
RSCWN 5/7	RKCWN 5/7	5	Ø 3.0-6.5 mm /SW 15
RSCWN 5/9	RKCWN 5/9		Ø 4.0-8.0 mm /SW 19



Field Attachable Connectors

M12 Field Attachable Connectors (DUO)

RSC...DUO | RKC...DUO



Male, 4- and 5-Pole

Field attachable connector, M12 Duo male connector, 4- and 5-pole with threaded joint, for two cable connections, assembling with screw terminals.

RSC...DUO

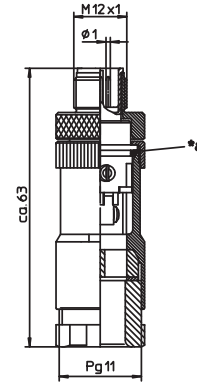

*a O-Ring

RKC...DUO

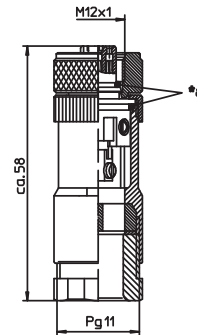

*a O-Ring



Female, 4- and 5-Pole

Field attachable connector, M12 Duo female connector, 4- and 5-pole with threaded joint, for two cable connections, assembling with screw terminals.

Pin Assignments

Face Views / M12, Male / Female

4 pole

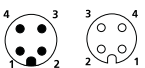

5 pole

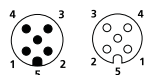



Be Certain with Belden

M12 Field Attachable Connectors (DUO)
RSC...DUO | RKC...DUO

Technical Data

Environmental

Degree of protection IP 67 / NEMA 6P
Operating temperature range -25°C (-13°F) / +90°C (+194°F)

Mechanical

Housing / Molded body PBT
Insert PBT
Contact CuZn, pre-coppered, CuSnZn
Receptacle shell CuZn, nickel plated
O-ring FKM
Mode of connection Screw terminals
Connectable conductor max. 0.75 mm²

Electrical

Contact resistance ≤ 5 mΩ
Nominal current at 40°C 4 A
Nominal voltage 4 poles 240 V
5 poles 60 V
Rated voltage 4 poles 250 V
5 poles 63 V
Test voltage 4 poles 2.0 kV eff. / 60 s
5 poles 1.5 kV eff. / 60 s
Insulation resistance > 10⁹ Ω
Pollution degree 3

Part Number		Pins	Cable Diameter Range	Characteristics
Male	Female			
RSC 4/DUO	RKC 4/DUO	4	2 x 3 mm / 2 x 5 mm	
RSC 5/DUO	RKC 5/DUO	5	2 x 3 mm / 2 x 5 mm	

M12 Field Attachable Connectors (DUO)

RSCN...DUO | RKC�...DUO



Male, 4-Pole

Field attachable connector, M12 Duo male connector, 4-pole with threaded joint, for two cable connections, assembling with screw terminals.

– especially designed for use in food processing equipment –

RSCN...DUO

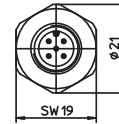
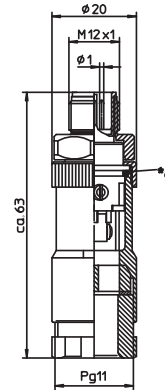

*a O-Ring



Female, 4-Pole

Field attachable connector, M12 Duo female connector, 4-pole with threaded joint, for two cable connections, assembling with screw terminals.

– especially designed for use in food processing equipment –

RKC�...DUO

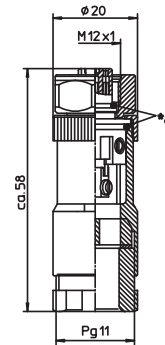

*a O-Ring

Pin Assignments

Face Views / M12, Male / Female

4 pole

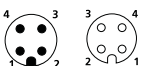

5 pole

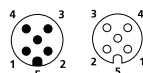



Be Certain with Belden

M12 Field Attachable Connectors (DUO)

RSC...DUO | RKC...DUO

Technical Data

Environmental

Degree of protection IP 67 / NEMA 6P
 Operating temperature range -25°C (-13°F) / +90°C (+194°F)

Mechanical

Housing / Molded body PBT
 Insert PBT
 Contact CuZn, pre-coppered, CuSnZn
 Receptacle shell Stainless steel
 O-ring FKM
 Mode of connection Screw terminals
 Connectable conductor max. 0.75 mm²

Electrical

Contact resistance ≤ 5 mΩ
 Nominal current at 40°C 4 A
 Nominal voltage 240 V
 Rated voltage 250 V
 Test voltage 2.0 kV eff. / 60 s
 Insulation resistance > 10⁹ Ω
 Pollution degree 3

Part Number		Pins	Cable Diameter Range	Characteristics
Male	Female			
RSCN 4/DUO	RKCN 4/DUO	4	2 x 3 mm / 2 x 5 mm	

M12 Field Attachable Connectors

RSCS | 0976 PMC 101 | RKCS | 0976 PFC 101



Male, 4-, 5-, and 8-Pole

Field attachable connector, M12 male connector 4-, 5-, and 8-pole with threaded joint, shieldable, assembling with screw terminals.

- 0976 PMC 101: 5 poles, B coding, especially suitable for Profibus signal cable 0975 254 000/... M -

RSCS | 0976 PMC 101

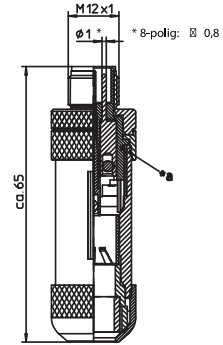

*a O-Ring



Female, 4-, 5-, and 8-Pole

Field attachable connector, M12 female connector 4-, 5-, and 8-pole with threaded joint, shieldable, assembling with screw terminals.

- 0976 PFC 101: 5 poles, B coding, especially suitable for Profibus signal cable 0975 254 000/... M -

RKCS | 0976 PFC 101

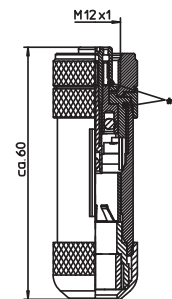

*a O-Ring

Pin Assignments

Face Views / M12, Male / Female

4 pole

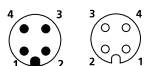

5 pole

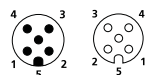

5 pole B coding

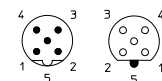

8 pole

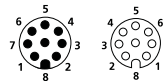



Be Certain with Belden

M12 Field Attachable Connectors

RSCS | 0976 PMC 101 | RKCS | 0976 PFC 101

Technical Data

Environmental









Degree of protection IP 67 / NEMA 6P
 Operating temperature range -25°C (-13°F) / +90°C (+194°F)

Mechanical

Housing / Molded body GD-ZnAl, pre-coppered and nickel-plated
 Insert PBT, RSCS 8/9: PA
 Contact CuZn, pre-coppered, CuSnZn
 Receptacle shell CuZn, nickel-plated
 Shield sleeve CuBe, tin-plated
 O-ring FKM
 Mode of connection Screw terminals
 Connectable conductor max. 0.75 mm²

Electrical

Contact resistance ≤ 5 mΩ
 Nominal current at 40°C 3–5 poles 4 A, 8 poles 2 A
 Nominal voltage 3–4 poles 120 V, 5 poles 60 V, 8 poles 30 V
 Rated voltage 3–4 poles 125 V, 5 poles 63 V, 8 poles 36 V
 Test voltage 3–4 poles 1.5 kV eff. / 60 s, 5–8 poles 1.0 kV eff. / 60 s
 Insulation resistance > 10⁹ Ω
 Pollution degree 3

Part Number	Pins	Cable Diameter Range	Characteristics
Male	Female		
RSCS 4/9	RKCS 4/9	4	∅ 4.0–9.0 mm  
RSCS 5/9	RKCS 5/9	5	∅ 4.0–9.0 mm  
0976 PMC 101	0976 PFC 101	5B	∅ 4.0–9.0 mm   
RSCS 8/9	RKCS 8/9	8	∅ 4.0–9.0 mm  

M12 Field Attachable Connectors

RSCQS | 0976 PMC 102 | 0986 EMC 102
RKCQS | 0976 PFC 102



Male, 3- and 4-Pole

Field attachable connector, M12 male connector, 3- and 4-pole with threaded joint, shieldable, assembling with spring-type terminals.

- 0976 PMC 102: 4 poles, B coding, especially suitable for Profibus signal cable 0975 254 000/...M -
- 0986 EMC 102: 4 poles, D coding, especially suitable for Industrial EtherNet data cable 0985 342 000/... M -

RSCQS | 0976 PMC 102 | 0986 EMC 102

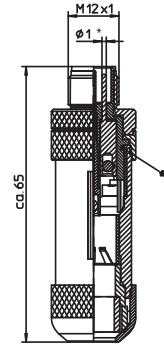

*a O-Ring



Female, 3- and 4-Pole

Field attachable connector, M12 female connector, 3- and 4-pole with threaded joint, shieldable, assembling with spring-type terminals.

- 0976 PFC 102: 4 poles, B coding, especially suitable for Profibus signal cable 0975 254 000/... M -

RKCQS | 0976 PFC 102

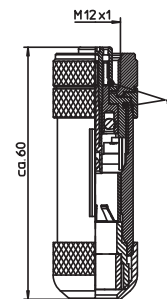

*a O-Ring

Pin Assignments

Face Views / M12, Male / Female

3 pole

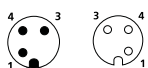

4 pole



4 pole B-coding



4 pole D-coding





Be Certain with Belden

M12 Field Attachable Connectors

RSCQS | 0976 PMC 102 | 0986 EMC 102 | RKCQS | 0976 PFC 102

Technical Data

Environmental

Degree of protection IP 67 / NEMA 6P
 Operating temperature range -25°C (-13°F) / +90°C (+194°F)

Mechanical

Housing / Molded body GD-ZnAl, pre-coppered and nickel-plated
 Insert PBT
 Contact Stainless steel, silver-plated, gold-plated
 Receptacle shell CuZn, nickel-plated
 Shield sleeve CuBe, tin-plated
 O-ring FKM
 Mode of connection Spring-type terminals
 Connectable conductor 0.14–0.50 mm², 0.14 mm² with terminal pin sleeve

Electrical

Contact resistance ≤ 5 mΩ
 Nominal current at 40°C 4 A
 Nominal voltage 120 V
 0976 PMC 102: 32 V
 Rated voltage 125 V
 Test voltage 1.5 kV eff. / 60 s
 0976 PMC 102: 0.65 kV eff. / 60 s
 Insulation resistance > 10⁹ Ω
 Pollution degree 3

Part Number	Pins	Cable Diameter Range	Characteristics
Male	Female		
RSCQS 3/9	RKCQS 4/3/9	3	∅ 4.0–9.0 mm
RSCQS 4/9	RKCQS 4/9	4	∅ 4.0–9.0 mm
0976 PMC 102	0976 PFC 102	4B	∅ 4.0–9.0 mm
0976 EMC 102		4D	∅ 4.0–9.0 mm

1/2"-20 Field Attachable Connectors

RSC 3U | RKC 3U



Male, 3-Pole

Field attachable connector, 1/2"-20 male connector, 3-pole, dual keyway with threaded joint, assembling with screw terminals.

RSC 3U

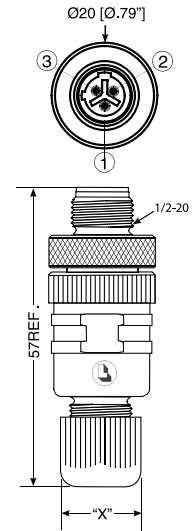

Female, 3-Pole

Field attachable connector, 1/2"-20 female connector, 3-pole, dual keyway with threaded joint, assembling with screw terminals.

RKC 3U

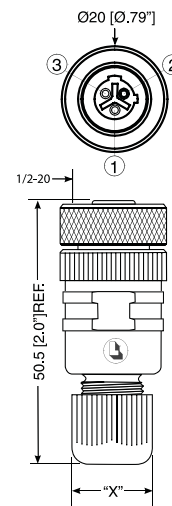

Pin Assignments

Face Views / 1/2"-20, Male / Female

3 pole

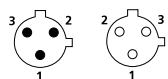



Be Certain with Belden

1/2"-20 Field Attachable Connectors

RSC 3U | RKC 3U

Technical Data

Environmental





Degree of protection IP 67 / NEMA 6P
 Operating temperature range -25°C (-13°F) / +90°C (+194°F)

Mechanical

Housing / Molded body Nylon, black
 Insert Nylon, black
 Contact Brass, tin alloy-plated
 Coupling nut Brass, nickel-plated
 O-ring FKM
 Mode of connection Screw terminals
 Connectable conductor 18 AWG / 0.75 mm²

Electrical

Contact resistance ≤ 5 mΩ
 Nominal current at 40°C 4 A
 Nominal voltage 250 V

Part Number		Pins	Cable Diameter Range	Characteristics
Male	Female			
RSC 3U/7	RKC 3U/7	3	3.0 - 6.5 mm	 
RSC 3U/9	RKC 3U/9		4.0 - 8.0 mm	 

1/2"-20 Field Attachable Connectors

RSCW 3U | RKCW 3U



Male, 3-Pole

Field attachable connector, 1/2"-20 male right angle connector, 3-pole, dual keyway with threaded joint, assembling with screw terminals.

RSCW 3U

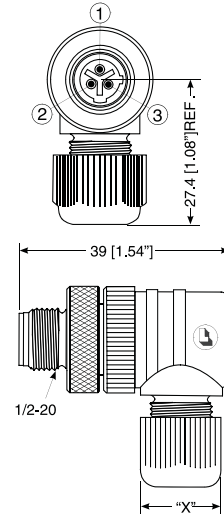

Female, 3-Pole

Field attachable connector, 1/2"-20 female right angle connector, 3-pole, dual keyway with threaded joint, assembling with screw terminals.

RKCW 3U

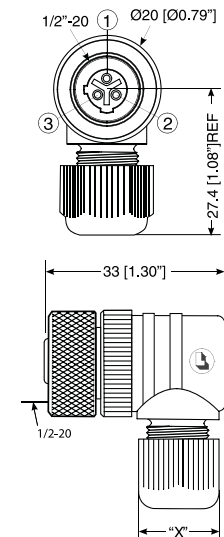

Pin Assignments

Face Views / 1/2"-20, Male / Female

3 pole

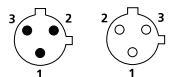



Be Certain with Belden

1/2"-20 Field Attachable Connectors
RSCW 3U | RKCW 3U

Technical Data

Environmental





Degree of protection IP 67 / NEMA 6P
Operating temperature range -25°C (-13°F) / +90°C (+194°F)

Mechanical

Housing / Molded body Nylon, black
Insert Nylon, black
Contact Brass, tin alloy-plated
Coupling nut Brass, nickel-plated
O-ring FKM
Mode of connection Screw terminals
Connectable conductor 18 AWG / 0.75 mm²

Electrical

Contact resistance ≤ 5 mΩ
Nominal current at 40°C 4 A
Nominal voltage 250 V

Part Number		Pins	Cable Diameter Range	Characteristics
Male	Female			
RSCW 3U/7	RKCW 3U/7	3	3.0 - 6.5 mm	 
RSCW 3U/9	RKCW 3U/9		4.0 - 8.0 mm	 

Field Attachable Connectors

Mini, 7/8" Field Attachable Connectors

RSC 30-RSC 50 | RKC 30-RKC 50



Male, 3-, 4-, and 5-Pole

Field attachable connector, Mini, 7/8" male connector 3-, 4-, and 5-pole with threaded joint, assembling with screw terminals.

RSC 30-RSC 50

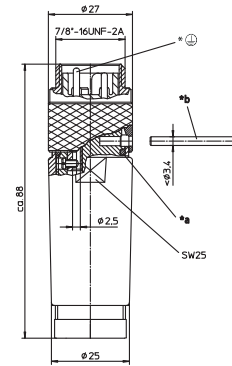

- *a O-ring
- *b Pin or screwdriver as assembly tool
- *c Contact 1.5 leading



Female, 3-, 4-, and 5-Pole

Field attachable connector, Mini, 7/8" female connector 3-, 4-, and 5-pole with threaded joint, assembling with screw terminals.

RKC 30-RKC 50

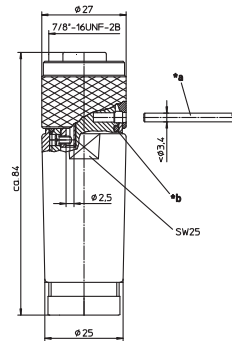

- *a O-ring
- *b Pin or screwdriver as assembly tool

Pin Assignments

Mini, 7/8" - Male / Female

3 poles

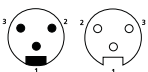

4 poles

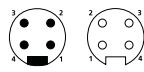

5 poles

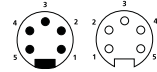



Be Certain with Belden

Mini, 7/8" Field Attachable Connectors

RSC 30-RSC 50 | RKC 30-RKC 50

Technical Data

Environmental













Degree of protection IP 67 / NEMA 6P
 Operating temperature range -40°C (-40°F) / +90°C (+194°F)

Mechanical

Housing / Molded body PA
 Insert TPU, self-extinguishing
 Contact CuZn, gold over nickel plated
 Coupling nut Al anodized
 O-ring NBR
 Mode of connection screw terminals
 Connectable conductor max. 1.5 mm²

Electrical

Contact resistance ≤ 5 mΩ
 Nominal current at 40°C
 3 poles 12 A
 4-5 poles 9 A
 Nominal voltage 240 V
 Rated voltage 250 V
 Test voltage
 3 poles 2.5 kV eff. / 60 s
 4-5 poles 1.5 kV eff. / 60 s
 Insulation resistance > 10⁹ Ω
 Pollution degree 3

Part Number		Pins	Cable Diameter Range	Characteristics
Male	Female			
RSC 30/9	RKC 30/9	3	Ø 6.0 - 8.0 mm	 
RSC 30/11	RKC 30/11		Ø 8.0 - 10.0 mm	 
RSC 40/9	RKC 40/9	4	Ø 6.0 - 8.0 mm	 
RSC 50/9	RKC 50/9	5	Ø 6.0 - 8.0 mm	 
RSC 50/11	RKC 50/11		Ø 8.0 - 10.0 mm	 
RSC 50/16	RKC 50/16		Ø 12.0 - 14.0 mm	 

Mini, 7/8" Field Attachable Connectors (Internal Threads)

RSC 301-RSC 501



Male, 3-, 4-, and 5-Pole

Field attachable connector, Mini, 7/8" male connector, 3-, 4-, and 5-pole with internal threaded joint, assembling with screw terminals.

RSC 301-RSC 501

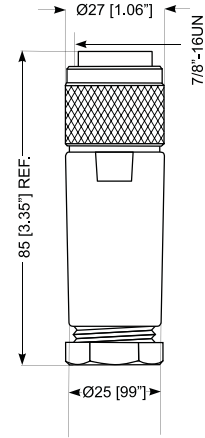

TL_RSC3019

Pin Assignments

Mini, 7/8" - Male / Female

3 poles

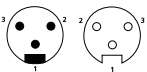

4 poles

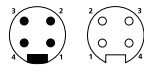

5 poles

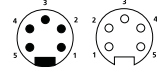



Be Certain with Belden

Mini, 7/8" Field Attachable Connectors (Internal Threads)
RSC 301-RSC 501

Technical Data

Environmental

Degree of protection IP 67 / NEMA 6P
Operating temperature range -40°C (-40°F) / +90°C (+194°F)

Mechanical

Housing / Molded body Glass filled nylon
Insert Nylon, black
Contact CuZn, gold over nickel plated
Coupling nut Al anodized
Mode of connection screw terminals
Connectable conductor max. 1.5 mm²

Electrical

Contact resistance ≤ 5 mΩ
Nominal current at 40°C 3 poles 12 A
4-5 poles 9 A
Nominal voltage 600 V
Insulation resistance > 10⁹ Ω
Pollution degree 3

Part Number	Pins	Cable Diameter Range	Characteristics
Male			
RSC 301/9	3	Ø 6.0 - 8.0 mm	
RSC 301/11		Ø 8.0 - 10.0 mm	
RSC 301/13.5		Ø 10.0 - 12.0 mm	
RSC 301/16		Ø 12.0 - 14.0 mm	
RSC 401/9	4	Ø 6.0 - 8.0 mm	
RSC 401/11		Ø 8.0 - 10.0 mm	
RSC 401/13.5		Ø 10.0 - 12.0 mm	
RSC 401/16		Ø 12.0 - 14.0 mm	
RSC 501/9	5	Ø 6.0 - 8.0 mm	
RSC 501/11		Ø 8.0 - 10.0 mm	
RSC 501/13.5		Ø 10.0 - 12.0 mm	
RSC 501/16		Ø 12.0 - 14.0 mm	

M23 Field Attachable Connectors

RSC-F-120/13.5 | RSC 190/9



Male, 12-Pole

Field attachable connector, M23 male connector 12-pole with threaded joint, external thread, assembling with solder connections.

RSC-F-120/13.5

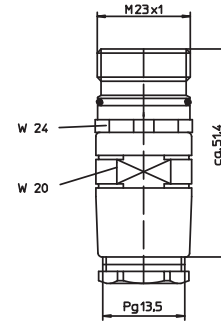

Male, 19-Pole

Field attachable connector, M23 male connector, 19-pole with threaded joint, assembling with solder connections.

RSC 190/9

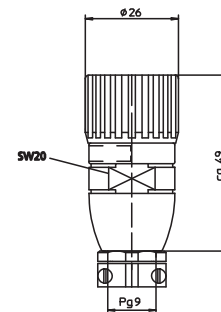

Pin Assignments

M23 - Male

12 poles



19 poles





Be Certain with Belden

M23 Field Attachable Connectors

RSC-F-120/13.5 | RSC 190/9

Technical Data

Environmental





Degree of protection	RSC-F-120/13.5: IP 67 RSC 190/9: IP 65
Operating temperature range	RSC-F-120/13.5: -40°C (-40°F) / +90°C (+194°F) RSC 190/9: -25°C (-13°F) / +110°C (+230°F)

Mechanical

Housing / Molded body	CuZn, nickel-plated
Insert	RSC-F-120/13,5: PBT GF RSC 190/9: PA
Contact	CuZn, pre-nickel and gold-plated
Receptacle shell	CuZn, nickel-plated
O-ring	FKM (only RSC-F-120/13,5)
Mode of connection	solder connection
Connectable conductor	max. 1.0 mm ²

Electrical

Contact resistance	RSC-F-120/13,5: ≤ 5 mΩ RSC 190/9: ≤ 3 mΩ
Nominal current at 40°C	RSC-F-120/13,5: 8 A RSC 190/9: 16 x 8 A / 3 x 10 A
Nominal voltage	150 V
Test voltage	1.5 kV eff. / 60 s
Insulation resistance	> 10 ⁹ Ω
Pollution degree	3

Part Number	Pins	Cable Diameter Range	Characteristics
Male	Male		
RSC-F-120/13.5	12	Ø 10.0 - 14.0 mm	 
	RSC 190/9	19	Ø 6.0 - 10.0 mm
			 

M23 Field Attachable Connectors

RKC.../13.5 | RKCW...13.5



Female, 12- and 19-Pole

Field attachable connector, M23 female connector 12- and 19-pole with threaded joint, external thread, assembling with solder connections.

RKC.../13.5

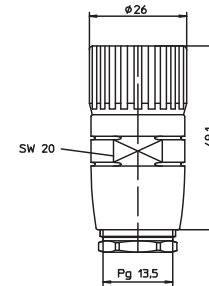

Female, 12- and 19-Pole

Field attachable connector, M23 female connector 12- and 19-pole, right angle with threaded joint, external thread, assembling with solder connections.

RKCW...13.5

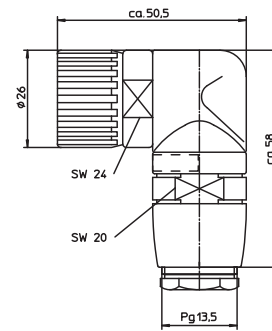

Pin Assignments

M23 - Male

12 poles



19 poles





Be Certain with Belden

M23 Field Attachable Connectors

RKC.../13.5 | RKCW...13.5

Technical Data

Environmental





Degree of protection IP 67
Operating temperature range -40°C (-40°F) / +125°C (+257°F)

Mechanical

Housing / Molded body CuZn, nickel-plated
Insert PBT GF
Contact CuZn, pre-nickel and 0.8 microns gold-plated
Receptacle shell CuZn, nickel-plated
O-ring FKM
Mode of connection solder connection
Connectable conductor max. 1.0 mm²

Electrical

Contact resistance ≤ 5 mΩ
Nominal current at 40°C 12 poles 7.5 A
19 poles 7.5 A pin Ø 1 mm, 10 A pin Ø 1.5 mm
Nominal voltage 12 poles 240 V
19 poles 120 V
Rated voltage 12 poles 250 V
19 poles 125 V
Test voltage 12 poles 2.5 kV eff./ 60 s
19 poles 1.5 kV eff./ 60 s
Insulation resistance > 10⁹ Ω
Pollution degree 3

Part Number		Pins	Cable Diameter Range	Characteristics
Female	Female 90°			
RKC 120/13.5	RKCW 120/13.5	12	Ø 10.0 - 14.0 mm	 
RKC 190/13.5	RKCW 190/13.5	19	Ø 10.0 - 14.0 mm	 

Accessories

ZVKM



Dust Cover M8

Dust Cover for Unused M8 Sockets

Part No.

ZVKM

ZVK



Dust Cover M12

Dust Cover for Unused M12 Sockets

Part No.

ZVK

PZVK



Dust Cover M12

PVC Dust Cover for Unused M12 Sockets.
– especially designed for use in Food Processing Equipment –

Part No.

PZVK

ZVK 2

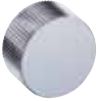

Dust Cover M23

Dust Cover for Unused M23 Male Connectors.

Part No.

ZVK 2

0909 UAC 101



Dust Cover M12

Dust Cover for Unused M12 Male Connectors.

Part No.

0909 UAC 101

RKV



Dust Cover 7/8" Female

Dust Cover for Unused 7/8" Female Connectors.

Part No.

RKV

RSV



Dust Cover 7/8" Male

Dust Cover for Unused 7/8" Male Connectors.

Part No.

RSV

RKV M23



Dust Cover M23 Female

Dust Cover for Unused M23 Female Connectors.

Part No.

RKV M23

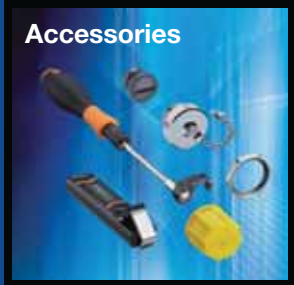

Be Certain with Belden

Accessories

RSV M23



Dust Cover 7/8" Male
Dust Cover for Unused M23 Male Connectors.

Part No.
RSV M23

RS-TU | RS-TU B | RS-TU C



Threaded Adapter Mini
Threaded Adapters for 7/8", 1", and 1 1/8" Mini Style Connectors.

Part No.
RS-TU
RS-TU B
RS-TU C

RSKF 8



Panel Nut
Panel Nut for M8 Male and Female Receptacles

Part No.
RSKF 8

RSKF 9 | RSKFM | RSKFM 20



Panel Nut
Panel Nut for M12 Male and Female Receptacles
RSKF 9: PG 9
RSKFM 16: M16 x1,5
RSKFM 20: M20X1,5

Part No.
RSKF 9
RSKFM 16
RSKFM 20

RSKF 11 | RSKF 13.5



Panel Nut
Panel Nut for 7/8" Male and Female Receptacles

Part No.
RSKF 11
RSKF 13,5

ZKS 1



Mounting Clip-M12
Mounting Clip for M12-Connectors

Part No.
ZKS 1

ZKS 2



Mounting Clip-M8
Mounting Clip for M8-Connectors

Part No.
ZKS 2

Accessories

DMWKZ



Torque Wrench-M8 and M12

Torque Wrench for M8 and M12 Connectors.
Attachments for M12 Connectors are Included

Part No.

DMWKZ

DMEWKZ 8



Torque Wrench Attachment-M8

Torque Wrench Attachment for M8 Connectors

Part No.

DMWKZ 8

DMEWKZ 8



Torque Wrench Attachment-M8

Torque Wrench Attachment for M8 Field
Attachable Connectors

Part No.

DMWKZ K 8

DMEWKZ K 12



Torque Wrench Attachment-M12

Torque Wrench Attachment for M12 Field
Attachable Connectors

Part No.

DMWKZ K 12

ZBS



Attachable Labels - 7 x 14 mm

Attachable Labels, 7 x 14 mm, 10 pieces.

– suitable for all ASB distribution boxes (M12)
passive and all compact bus modules active –

Part No.

ZBS

ZBR 5/10



Attachable Labels - 5 x 10 mm

Attachable Labels, 5 x 10 mm, 40 pieces.

– suitable for all ASB distribution boxes (M8) –

Part No.

ZBR 5/10

ZBR 8/40



Attachable Labels - 8 x 17 mm

Attachable Labels, 8 x 17 mm, 40 pieces.

– suitable for all ASB distribution boxes (M12)
passive and all compact bus modules active –

Part No.

ZBR 8/40

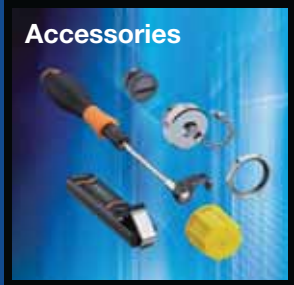

Be Certain with Belden

Accessories

ZBST



Marking Pen

Recommended ink for plotter: INK 2000 and Clean 2000 from Weidmüller.

Part No.

ZBST

STS-Clip



Securing Clip

Securing Clip for Molded Connectors to Electrical Operating Equipment.

– suitable for use in areas with combustible dusts according to EN 50281-1-1 –

Part No.

STS-Clip

AWKZ 3/4



Stripping Tool

Stripping Tool for 3 and 5 Pole Cables.

– especially suitable for the stripping of 234 and 255 cable types –

Part No.

AWKZ 3/4

AWKZ 5



Stripping Tool

Stripping Tool for 5 Pole Cables.

– especially suitable for the stripping of 228 cable types –

Part No.

AWKZ

AWKZ 12/19



Cable Cutter

Cable Cutter for the Fast Stripping of all Commercial Round Cables with a Diameter of 4 to 15 mm, Turnable Inner Cutter to Perform Circular Cuts as well as Rip Cuts.

Part No.

AWKZ 12/19

Accessories

ZMS 19



Installation Wrench-M23

Installation Wrench for M23 12 and 19 Pole Male and Female Connectors.

Part No.

ZMS 19

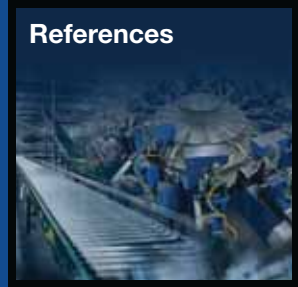

Be Certain with Belden

Part Number Configurations: Mini Cord Sets

RK 30 - 688 / 6F

Poles	Wires/ Gauge	Cable Type	Jacket Color	UL Rating	Color Code	Female Straight	Female 90°	Male Straight Internal Threads	Male Straight External Threads	Male 90° Internal Threads	Male 90° External Threads	Cable Code	Standard Cable Lengths (Feet and Meters)
2	2/16 AWG	PVC	Yellow	STOW	U.S.	RK 20	RKW 20	RS 201		RSW 201		678	6F, 12F, 15F, 20F, 30F
2	2/18 AWG	PVC	Yellow	AWM 2661	IEC	RK 20	RKW 20		RS 20		RSW 20	603	2M, 5M, 10M
3	3/16 AWG	TPE	Yellow	SEOOW	Automotive	RK 30	RKW 30	RS 301		RSW 301		741	6F, 12F, 15F, 20F, 30F
3	3/18 AWG	PVC	Yellow	AWM 2661	Automotive	RK 30	RKW 30	RS 301		RSW 301		688	6F, 12F, 15F, 20F, 30F
3	3/18 AWG	PVC	Yellow	AWM 2661	IEC	RK 30	RKW 30		RS 30		RSW 30	601	2M, 5M, 10M
3	3/18 AWG	PUR	Yellow	AWM 20233	IEC	RK 30	RKW 30		RS 30		RSW 30	645	2M, 5M, 10M
3	3/18 AWG	TPE	Yellow	PLTC	IEC	RK 30	RKW 30		RS 30		RSW 30	731	6F, 12F, 15F, 20F, 30F
3	3/16 AWG	TPE	Yellow	SEOOW	U.S.	RK 30	RKW 30	RS 301		RSW 301		738	6F, 12F, 15F, 20F, 30F
3	3/18 AWG	CPE	Yellow	S00W	U.S.	RK 30	RKW 30	RS 301		RSW 301		619	6F, 12F, 15F, 20F, 30F
4	4/18 AWG	PUR	Yellow	AWM 20233	IEC	RK 40	RKW 40		RS 40		RSW 40	602	2M, 5M, 10M
4	4/18 AWG	TPE	Yellow	AWM 20327	IEC	RK 40	RKW 40		RS 40		RSW 40	637	6F, 12F, 15F, 20F, 30F
4	4/16 AWG	TPE	Yellow	SEOOW	U.S.	RK 40	RKW 40	RS 401		RSW 401		739	6F, 12F, 15F, 20F, 30F
5	5/16 AWG	TPE	Yellow	SEOOW	Automotive	RK 50	RKW 50	RS 501		RSW 501		742	6F, 12F, 15F, 20F, 30F
5	5/18 AWG	TPE	Yellow	PLTC	Automotive	RK 50	RKW 50	RS 501		RSW 501		755	6F, 12F, 15F, 20F, 30F
5	5/18 AWG	TPE	Yellow	PLTC	IEC	RK 50	RKW 50		RS 50		RSW 50	794	6F, 12F, 15F, 20F, 30F
5	5/16 AWG	TPE	Yellow	SEOOW	U.S.	RK 50	RKW 50	RS 501		RSW 501		777	6F, 12F, 15F, 20F, 30F
6	6/16 AWG	PVC	Yellow	STOW	U.S.	RK 60A	RKW 60A	RS 601A		RSW 601A		696	6F, 12F, 15F, 20F, 30F
6	6/18 AWG	PVC	Yellow	STOW	U.S.	RK 60B		RS 601B				697	6F, 12F, 15F, 20F, 30F
7	7/16 AWG	PVC	Yellow	STOW	U.S.	RK 70M		RS 701M				622	6F, 12F, 15F, 20F, 30F
7	7/18 AWG	PUR	Yellow	AWM 20233	U.S.	RK 70M		RS 701M				649	6F, 12F, 15F, 20F, 30F
8	8/16 AWG	PVC	Yellow	STOW	U.S.	RK 80M		RS 801M				698	6F, 12F, 15F, 20F, 30F
8	8/18 AWG	PUR	Yellow	AWM 20233	U.S.	RK 80M		RS 801M				650	6F, 12F, 15F, 20F, 30F
9	9/16 AWG	PVC	Yellow	STOW	U.S.	RK 90M		RS 901M				623	6F, 12F, 15F, 20F, 30F
9	9/18 AWG	PUR	Yellow	AWM 20233	U.S.	RK 90M		RS 901M				651	6F, 12F, 15F, 20F, 30F
10	10/16 AWG	PVC	Yellow	STOW	U.S.	RK 100M		RS 1001M				699	6F, 12F, 15F, 20F, 30F
10	10/18 AWG	PUR	Yellow	AWM 20233	U.S.	RK 100M		RS 1001M				652	6F, 12F, 15F, 20F, 30F
12	11/18 AWG	TPE	Yellow	SEOOW	IEC	RK 120M		RS 1201M	RS 120M			728	6F, 12F, 15F, 20F, 30F
12	12/18 AWG	PUR	Yellow	AWM 20233	Numeric	RK 120M		RS 1201M	RS 120M			676	2M, 5M, 10M, 15M
12	12/16 AWG	TPE	Yellow	SEOOW	U.S.	RK 120M		RS 1201M				724	6F, 12F, 15F, 20F, 30F
12	12/18 AWG	PUR	Yellow	AWM 20233	U.S.	RK 120M		RS 1201M				654	6F, 12F, 15F, 20F, 30F
19	19/18 AWG	PUR	Yellow	AWM 20233	Numeric	RK 190M		RS 1901M	RS 190M			669	2M, 5M, 10M, 15M

Table 1: Part Number Configurations for Mini Cord Sets

EXAMPLE: Single and Double Ended Cord sets

RK 30-738/12F = Mini, Single Ended Cordset, Female Straight, 3 Pole, TPE Cable, 12 Foot Cable Length. To build a Double Ended Cordset, add **RK** after **RS**, e.g. **RSRK 301-738/12F**.

NOTE: Areas without a part number identifier are considered to be a special order.

Part Number Configurations: Mini Receptacles

RKF 301 - 638 / 1F

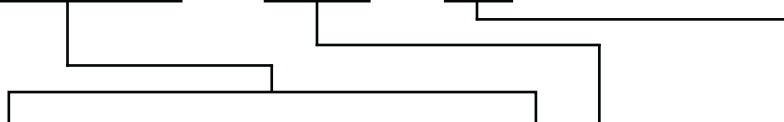

Pins/ Poles	Panel Mount	Threads	Voltage Rating	Color Code	Female Terminal Block	Male Terminal Block	Female Straight	Male Straight	Wire Code	Lead Length
2	Front	1/2" NPT	300 V	IEC			RKF 20	RSF 20	603	0.3M
2	Front	1/2" NPT	600 V	U.S.			RKF 201	RSF 20	678	1F
3	Front	1/2" NPT	600 V	Automotive			RKF 301	RSF 30	641	1F
3	Front	1/2" NPT	300 V	IEC			RKF 30	RSF 30	695	0.3M
3	Front	1/2" NPT	600 V	U.S.			RKF 301	RSF 30	638	1F
4	Front	1/2" NPT	300 V	IEC			RKF 40	RSF 40	693	0.3M
4	Front	1/2" NPT	600 V	U.S.			RKF 401	RSF 40	639	1F
4	Terminal Block Receptacle				RKF 401 TB					
5	Front	1/2" NPT	600 V	Automotive			RKF 501	RSF 50	642	1F
5	Front	1/2" NPT	300 V	Automotive			RKF 501	RSF 50	690	1F
5	Front	1/2" NPT	300 V	IEC			RKF 50	RSF 50	694	0.3M
5	Front	1/2" NPT	600 V	U.S.			RKF 501	RSF 50	677	1F
5	Terminal Block Receptacle				RKF 501 TB	RSF 50 TB				
6	Front	1/2" NPT	300 V	U.S.			RKF 601A	RSF 60A	697	1F
6	Front	1/2" NPT	600 V	U.S.			RKF 601B	RSF 60B	696	1F
7	Front	1/2" NPT	600 V	U.S.			RKF 701M	RSF 70M	622	1F
8	Front	1/2" NPT	600 V	U.S.			RKF 801M	RSF 80M	698	1F
9	Front	1/2" NPT	600 V	U.S.			RKF 901M	RSF 90M	623	1F
10	Front	1/2" NPT	600 V	U.S.			RKF 1001M	RSF 100M	699	1F
12	Front	1/2" NPT	300 V	Numeric			RKF 1201M	RSF 120M	676	1F
12	Front	1/2" NPT	600 V	U.S.			RKF 1201M	RSF 120M	624	1F
12	Front	1/2" NPT	300 V	IEC			RKF 1201M	RSF 120M	630	0.3M
19	Front	1/2" NPT	300 V	Numeric			RKF 1901M	RSF 190M	669	1F

Table 2: Part Number Configurations for Mini Receptacles

EXAMPLE: Receptacles

RKF 301-638/1F = Mini, receptacle, female, straight, 3-pole, front mount with 1/2" NPT threads, 600 V voltage rating, U.S. color code with 1 foot leads.

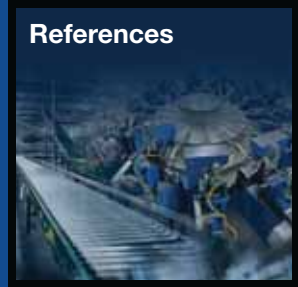

Be Certain with Belden

Part Number Configurations: Mini Distribution Boxes and Field Attachable Connectors

ZLU 4/L - 30

Ports	Signals Per Port	Voltage Rating	Mini Distribution Box	Ports/Lamps	Pin/Pole Connection
4	1	600 V	ZLU	4	30
4	1	95-120 V AC	ZLU	4/L	30
4	2	600 V	ZLU	4	50

Table 3: Part Number Configurations for Mini Distribution Boxes

EXAMPLE: Distribution Boxes

ZLU 4/L-30 = Mini, distribution box, female, 4-port with lamp indicators, 1 signal per port, 95-120 V AC voltage rating with 3-pole sensor connections.

RSC 301 / 9

Pins/Poles	Cable OD	Male Internal Threads	Male External Threads	Female	Thread Sizes
3	6.0mm to 8.0mm	RSC 301	RSC 30	RKC 30	9
3	8.0mm to 10.0mm	RSC 301	RSC 30	RKC 30	11
3	10.0mm to 12.0mm	RSC 301	RSC 30	RKC 30	13.5
3	12.0mm to 14.0mm	RSC 301	RSC 30	RKC 30	16
4	6.0mm to 8.0mm	RSC 401	RSC 40	RKC 40	9
4	8.0mm to 10.0mm	RSC 401	RSC 40	RKC 40	11
4	10.0mm to 12.0mm	RSC 401	RSC 40	RKC 40	13.5
4	12.0mm to 14.0mm	RSC 401	RSC 40	RKC 40	16
5	6.0mm to 8.0mm	RSC 501	RSC 50	RKC 50	9
5	8.0mm to 10.0mm	RSC 501	RSC 50	RKC 50	11
5	10.0mm to 12.0mm	RSC 501	RSC 50	RKC 50	13.5
5	12.0mm to 14.0mm	RSC 501	RSC 50	RKC 50	16

Table 4: Part Number Configurations for Field Attachable Connectors

EXAMPLE: Field Attachable Connector

RSC 301/9 = Mini, field attachable connector, 5-pole, male with internal threads, threads size PG9 with cable diameter of 6.0mm to 8.00mm.

Part Number Configurations: Micro M12 Cord Sets

RKWT 4 - 225 / 2M

Poles	Wires/ Gauge	Cable Type	Jacket	UL Rating	Color Code	Female Straight	Female 90°	Male Straight	Cable Code	Standard Cable Lengths (Feet and Meters)
3	3/22 AWG	PVC	Orange	AWM 2464	IEC	RKT 4-3	RKWT 4-3	RST 3	06	2M, 5M, 10M
3	3/22 AWG	PUR, Halogen Free	Black	AWM 21198	IEC	RKT 4-3	RKWT 4-3	RST 3	224	2M, 5M, 10M
3	3/22 AWG	PUR, Halogen Free, Weld Slag	Orange	AWM 21198	IEC	RKT 4-3	RKWT 4-3	RST 3	260	2M, 5M, 10M
3	3/22 AWG	PUR	Yellow	AWM 20233	IEC	RKT 4-3	RKWT 4-3	RST 3	610	2M, 5M, 10M
3	3/22 AWG	PVC	Yellow	AWM 2661	IEC	RKT 4-3	RKWT 4-3	RST 3	632	2M, 5M, 10M
3	3/18 AWG	PUR	Yellow	AWM 20233	IEC	RKT 4-3	RKWT 4-3	RST 3	645	2M, 5M, 10M
3	3/18 AWG	TPE	Yellow	PLTC	IEC	RKT 4-3	RKWT 4-3	RST 3	731	2M, 5M, 10M
4	4/24 AWG	PVC	Orange	AWM 2464	IEC	*PRKT 4	*PRKWT 4	*PRST 4	07	5M, 10M, 25M
4	4/22 AWG	PVC, Shielded	Orange		IEC	RKTS 4	RKWTH 4	RSTS 4	182	2M, 5M, 10M
4	4/22 AWG	PUR, Halogen Free	Black	AWM 21198	IEC	RKT 4	RKWT 4	RST 4	225	2M, 5M, 10M
4	4/22 AWG	PUR, Halogen Free, Weld Slag	Orange	AWM 21198	IEC	RKT 4	RKWT 4	RST 4	251	2M, 5M, 10M
4	4/22 AWG	PVC, Shielded	Black	AWM 21198	IEC	RSTS 4	RKWTH 4	RSTS 4	288	2M, 5M, 10M
4	4/18 AWG	PUR	Yellow	AWM 20233	IEC	RKT 4	RKWT 4	RST 4	602	2M, 5M, 10M
4	4/22 AWG	PVC	Yellow	AWM 2661	IEC	RKT 4	RKWT 4	RST 4	633	2M, 5M, 10M
4	4/22 AWG	PVC, Shielded	Yellow	AWM 2661	IEC	RKTH 4	RKWTH 4		635	2M, 5M, 10M
4	4/18 AWG	TPE	Yellow	PLTC	IEC	RKT 4	RKWT 4	RST 4	637	2M, 5M, 10M
4	4/22 AWG	TPE	Yellow	PLTC	IEC	RKT 4	RKWT 4	RST 4	643	2M, 5M, 10M
4	4/22 AWG	PUR	Yellow	AWM 20233	IEC	RKT 4	RKWT 4	RST 4	679	2M, 5M, 10M
5	5/22 AWG	PVC	Orange	AWM 2464	IEC	*PRKT 5	*PRKWT 5		56	5M, 10M, 25M
5	5/22 AWG	PVC, Shielded	Orange		IEC	RKTS 5		RSTS 5	183	2M, 5M, 10M
5	5/20 AWG	PUR, Halogen Free	Black	AWM 21198	IEC	RKT 5	RKWT 5	RST 5	228	2M, 5M, 10M
5	5/22 AWG	PUR, Halogen Free, Shielded	Black	AWM 21198	IEC	RKTS 5	RKWTH 5	RSTS 5	298	2M, 5M, 10M
5	5/22 AWG	PUR	Yellow	AWM 20233	IEC	RKT 5	RKWT 5	RST 5	644	2M, 5M, 10M
6	6/22 AWG	PUR, Halogen Free, Weld Slag	Orange	AWM 21198	IEC	RKT 8-6	RKWT 8-6		268	2M, 5M, 10M
6	6/22 AWG	PUR, Halogen Free	Black	AWM 21198	IEC	RKT 8-6	RKWT 8-6		337	2M, 5M, 10M
8	8/24 AWG	PVC, Shielded	Orange		IEC	RSTS 8	RKWTH 8	RSTS 8	184	2M, 5M, 10M
8	7/24 AWG	PUR, Halogen Free	Black	AWM 21198	IEC	RKT 8	RKWT 8	RST 8	282	2M, 5M, 10M
8	8/24 AWG	PUR, Halogen Free, Shielded	Black	AWM 21198	IEC	RSTS 8	RKWTH 8	RSTS 8	299	2M, 5M, 10M
8	8/24 AWG	PVC	Black	AWM 2661	IEC	RKT 8	RKWT 8	RST 8	627	2M, 5M, 10M
12	12/22 AWG	PUR, Halogen Free	Black		IEC	RKT 12		RST 12	348	2M, 5M, 10M

Table 5.1: Part Number Configurations for Micro M12 Cord Sets

EXAMPLE: Single and Double Ended Cord sets

RKWT 4-225/2M = Micro M12, Single Ended Cordset, Female 90°, 4 Pole, PUR Halogen Free, Black Cable, AWM 21198, IEC Color Code, 2 Meter Cable Length. To build a Double Ended Cordset, add **RST** before **RKWT**, e.g. **RST 4-RKWT 4-225/2M**. **NOTE:** Cable lengths for double-ended cord sets vary from the chart listing above - see actual technical specifications for part number in question.

* **PRKT** , **PRKWT**, and **PRST** indicate Stainless Steel Hardware - Especially Designed for Food and Beverage Applications.

NOTE: Areas without a part number identifier are considered to be a special order.

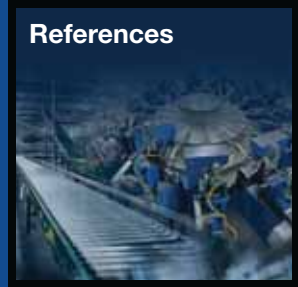

Be Certain with Belden

Part Number Configurations: Micro M12 Cord Sets - LED Versions

RKT/LED A 4-3 - 06 / 2M

Poles	Wires/ Gauge	Cable Type	Jacket	UL Rating	Color Code	Female Straight, LED A (npn), Normally Open Yellow-Green	Female 90°, LED A (npn), Normally Open Yellow-Green	Cable Code	Standard Cable Lengths (Feet and Meters)
3	3/22 AWG	PVC	Orange	AWM 2464	IEC	RKT/LED A 4-3	RKWT/LED A 4-3	06	2M, 5M, 10M
3	3/22 AWG	PUR, Halogen Free	Black	AWM 21198	IEC	RKT/LED A 4-3	RKWT/LED A 4-3	224	2M, 5M, 10M
3	3/22 AWG	PUR, Halogen Free, Weld Slag	Orange	AWM 21198	IEC	RKT/LED A 4-3	RKWT/LED A 4-3	260	2M, 5M, 10M
3	3/22 AWG	PVC	Yellow	AWM 2661	IEC	RKT/LED A 4-3	RKWT/LED A 4-3	632	2M, 5M, 10M

Poles	Wires/ Gauge	Cable Type	Jacket	UL Rating	Color Code	Female Straight, LED C (npn), Normally Open, Yellow-Green	Female 90°, LED C (npn), Normally Open, Yellow-Green	Cable Code	Standard Cable Lengths (Feet and Meters)
3	3/22 AWG	PVC	Yellow	AWM 2661	IEC	RKT/LED C 4-3	RKWT/LED C 4-3	632	2M, 5M, 10M
3	3/22 AWG	PUR, Halogen Free	Black	AWM 21198	IEC	RKT/LED C 4-3	RKWT/LED C 4-3	224	2M, 5M, 10M

Poles	Wires/ Gauge	Cable Type	Jacket	UL Rating	Color Code	Female Straight, LED F (npn), Normally Closed/Open, Yellow-Green	Female 90°, LED F (npn), Normally Closed/Open, Yellow-Green	Cable Code	Standard Cable Lengths (Feet and Meters)
4	4/22 AWG	PVC	Yellow	AWM 2661	IEC	RKT/LED F 4		633	2M, 5M, 10M
4	4/22 AWG	PUR, Halogen Free	Black	AWM 21198	IEC	RKT/LED F 4		225	2M, 5M, 10M

Poles	Wires/ Gauge	Cable Type	Jacket	UL Rating	Color Code	Female Straight, LED P (npn), Normally Closed/Open Yellow-Yellow- Green	Female 90°, LED P (npn), Normally Closed/Open Yellow-Yellow- Green	Cable Code	Standard Cable Lengths (Feet and Meters)
3	3/22 AWG	PVC	Yellow	AWM 2661	IEC		RKWT/LED P 4-3	632	2M, 5M, 10M
4	4/24 AWG	PVC	Orange	AWM 2464	IEC		RKWT/LED P 4-3	07	5M, 10M, 25M
4	4/24 AWG	PVC	Orange	AWM 2464	IEC		*PRKWT/LED P 4	07	5M, 10M, 25M
4	4/22 AWG	PUR, Halogen Free	Black	AWM 21198	IEC		RKWT/LED P 4	225	2M, 5M, 10M
4	4/22 AWG	PUR, Halogen Free, Weld Slag	Orange	AWM 21198	IEC		RKWT/LED P 4	251	2M, 5M, 10M
4	4/22 AWG	PVC	Yellow	AWM 2661	IEC		RKWT/LED P 4-3	633	2M, 5M, 10M

Poles	Wires/ Gauge	Cable Type	Jacket	UL Rating	Color Code	Female Straight, LED W (npn), Normally Closed/Open, Yellow-White- Green	Female 90°, LED W (npn), Normally Closed/Open, Yellow-White- Green	Cable Code	Standard Cable Lengths (Feet and Meters)
4	4/22 AWG	PUR, Halogen Free	Grey	AWM 21198	IEC		RKWT/LED W-4	265	2M, 5M, 10M

Table 5.2: Part Number Configurations for Micro M12 Cord Sets with Light Emitting Diodes

Part Number Configurations: Micro M12 Receptacles and Inserts

RKFM 4 / 0.5M

Poles	Panel Mount	Threads	Voltage Rating	Color Code	Female Straight	Male Straight	Male/ Female Panel Feed Through	Female Terminal Block	Male Terminal Block	Lead Length
3	Front	M16 x 1.5	240 V	IEC	RKFM 4-3	RSFM 3				0.5 M
3	Front	M20 x 1.5	240 V	IEC		RSFM 3/20				0.5 M
3	Front	M16 x 1.5 (adjustable nut)	240 V	IEC	RKFPM 3	RSFPM 3				0.5 M
3	Front	1/2"-14 NPT	250 V	IEC	RKF 3-1/2-14	RSF 3-1/2-14				0.5 M
3	Rear	PG9	250 V	IEC	RKF 3-S3103	RSF 3-S3103				0.5 M
3	Front	PG9	250 V	IEC	RKF 4-3	RSF 3				0.5 M
3	Front	M16 x 1.5	240 V	PCB	RKFM 3	RSFM 3				
3	Front	M16 x 1.5	240 V	PCB	PRSFM 3					
3	Rear	M10 x 1	60 V	PCB	RKMHL 3/S 5.5					
4	Front	M16 x 1.5	240 V	IEC	RKFM 4	RSFM 4				0.5 M
4	Front	M20 x 1.5	240 V	IEC		RSFM 4/20				0.5 M
4	Front	M16 x 1.5 (adjustable nut)	240 V	IEC	RKFPM 4	RSFPM 4				0.5 M
4	Front	M16 x 1.5 (stainless steel)	240 V	IEC	PRKFM 4	PRSFM 4				0.5 M
4	Front	1/2"-14 NPT	250 V	IEC	RKF 4-1/2-14	RSF 4-1/2-14				0.5 M
4	Rear	PG9	250 V	IEC	RKF 4-S3103	RSF 4-S3103				0.5 M
4	Front	PG9	250 V	IEC	RKF 4	RSF 4				0.5 M
4	Rear	PG9	240 V	PCB	RKHL 4/S 5.5	RSHL 4/S 5.5				
4	Front	M16 x 1.5	240 V	PCB	RKFM 4	RSFM 4				
4	Front	M16 x 1.5 (stainless steel)	240 V	PCB		PRSFM 4				
4	Rear	M10 x 1	30 V	PCB	RKMHL 4/S 5.5					
4	Insert		240 V	PCB	RSE 4					
4	Insert		240 V	PCB	RSEL 4					
4	Insert		240 V	PCB	RSELP					
4L	Insert		250 V	PCB	RSE 4L					
5	Front	M16 x 1.5	60 V	IEC	RKFM 5	RSFM 5				0.5 M
5	Front	M20 x 1.5	60 V	IEC	RKFM 5/20					0.5 M
5	Front	M16 x 1.5 (adjustable nut)	60 V	IEC	RKFPM 5	RSFPM 5				0.5 M
5	Front	M16 x 1.5 (stainless steel)	60 V	IEC	PRKFM 5	PRSFM 5				0.5 M
5	Front	1/2"-14 NPT	250 V	IEC	RKF 5-1/2-14	RSF 5-1/2-14				0.5 M
5	Rear	PG9	250 V	IEC	RKF 5-S3103	RSF 5-S3103				0.5 M
5	Front	PG9	250 V	IEC	RKF 5	RSF 5				0.5 M
5	Rear		60 V	Panel Feed Through			FWD			
5B	Rear		60 V	Panel Feed Through			FWD5			
5	Rear	PG9	60 V	PCB	RKHL 5/S 5.5	RSHL 5/S 5.5				

Table 6.1: Part Number Configurations for Micro M12 Receptacles

EXAMPLE: Receptacle

RKFM 4/0.5M = Micro M12, receptacle, female, straight, 4-pole, front mount with M16 x 1.5 threads, 240 V voltage rating, IEC color code with 0.5 meter leads. See next page (table 6.2) for additional part number configurations.

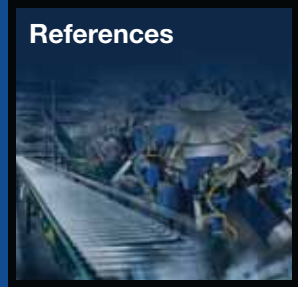

Be Certain with Belden

Part Number Configurations: Micro M12 Receptacles and Inserts (Continued)

RKFM 8 / 0.5M

Poles	Panel Mount	Threads	Voltage Rating	Color Code	Female Straight	Male Straight	Male/Female Panel Feed Through	Female Terminal Block	Male Terminal Block	Lead Length
5	Front	M16 x 1.5	60 V	PCB	RKFM 5	RSFM 5				
5	Front	M16 x 1.5 (stainless steel)	60 V	PCB		PRSFM 5				
5	Insert		60 V	PCB	RSE 5					
5	Insert		60 V	PCB	RSEQ 5					
5	Insert		60 V	PCB	RSEL 5					
5	Insert		60 V	PCB	RSELP					
5B	Rear	PG9	60 V	PCB	RKHL 5B/S 5.5	RSHL 5B/S 5.5				
5	Terminal Block Receptacle		250 V					RKF 5 TB	RSF 5TB	
8	Front	M16 x 1.5	30 V	IEC	RKFM 8	RSFM 8				0.5 M
8	Front	M16 x 1.5 (adjustable nut)	30 V	IEC	RKFPM 8	RSFPM 8				0.5 M
8	Front	M16 x 1.5 (stainless steel)	30 V	IEC	PRKFM 8	PRSFM 8				0.5 M
8	Front	1/2"-14 NPT	30 V	IEC	RKF 8-1/2-14	RSF 8-1/2-14				0.5 M
8	Rear	PG9	30 V	IEC	RKF 8-S3103	RSF 8-S3103				0.5 M
8	Front	PG9	30 V	IEC	RKF 8	RSF 8				0.5 M
8	Rear	PG9	50 V	PCB	RKHL 8/S 5.5	RSHL 8/S 5.5				
8	Insert		30 V	PCB	RSEL 8					

Table 6.1. Part Number Configurations for Micro M12 Receptacles

EXAMPLE: Receptacles

RKFM 8/0.5M = Micro M12, receptacle, female, straight, 8-pole, front mount with M16 x 1.5 threads, 240 V voltage rating, IEC color code with 0.5 meter leads.

Part Number Configurations: Micro M12 Distribution Boxes

ASB 8 / LED 5-4-328 / RS120M

Ports	Signals Per Port	Voltage Rating	Housing Color	On-Board Connection Type	Cable Type	M12 Distribution Box	Ports	LED	Pin/Wires	Integrated Control Cable	Separate I/O Power Supply	Terminal Block with Clamp Terminals on Back	Connected Home Run Cable	Cable Lengths
4	1	60 V	Orange		PUR HF, Black	ASB	4		5-4	328				5M, 10M
4	1	10-30 V DC	Orange		PUR HF, Black	ASB	4	LED	5-4	328				5M, 10M
4	1	10-30 V DC	Yellow		PUR HF, Black	ASB	4	LED	5-4	328			RS120M	1F
4	1	10-30 V DC	Orange	M23, 12 Pole		ASBS	4	LED	5-4					
4	2	60 V	Orange	M23, 19 Pole		ASBSV	4		5					
4	2	10-30 V DC	Orange	M23, 19 Pole		ASBSV	4	LED	5					
4	2	60 V	Orange		PUR HF, Black	ASBV	4		5	256				5M, 10M
4	2	10-30 V DC	Orange		PUR HF, Black	ASBV	4	LED	5	256				5M, 10M
4	2	250 V	Grey		PUR/PVC, Black	ASBV	4		4-3	138			RS120M	1F
4	2	10-30 V DC	Yellow		PUR, Black	ASBV	4	LED	5	256			RS120M	1F
6	1	60 V	Orange		PUR HF, Black	ASB	6		5-4	330				5M, 10M
6	1	10-30 V DC	Orange		PUR HF, Black	ASB	6	LED	5-4	330				5M, 10M
6	1	60 V	Orange	M23, 12 Pole		ASBS	6		5-4					
6	1	10-30 V DC	Orange	M23, 12 Pole		ASBS	6	LED	5-4					
6	2	60 V	Orange	M23, 19 Pole		ASBSV	6		5					
6	2	10-30 V DC	Orange	M23, 19 Pole		ASBSV	6	LED	5					
6	2	60 V	Orange		PUR HF, Black	ASBV	6		5	332				5M, 10M
6	2	10-30 V DC	Orange		PUR HF, Black	ASBV	6	LED	5	332				5M, 10M
8	1	60 V	Orange		PUR HF, Black	ASB	8		5-4	331				5M, 10M
8	1	10-30 V DC	Orange		PUR HF, Black	ASB	8	LED	5-4	331				5M, 10M
8	1	10-30 V DC	Orange			ASB	8	LED	5-4					1.5 M
8	1	10-30 V DC	Yellow		PUR HF, Black	ASB	8	LED	5-4	328			RS120M	1F
8	1	60 V	Orange	M23, 12 Pole		ASBS	8		5-4					
8	1	10-30 V DC	Orange	M23, 12 Pole		ASBS	8	LED	5-4					
8	1	10-30 V DC	Black	M23, 12 Pole		ASBS	8	LED	5-4		4E4A			
8	2	10-30 V DC	Orange			ASBSB	8	LED	5-4			SZ		
8	1	10-30 V DC	Orange	M23, 19 Pole		ASBSC	8	LED	5-4			SZ		
8	2	60 V	Orange	M23, 19 Pole		ASBSV	8		5					
8	2	10-30 V DC	Orange	M23, 19 Pole		ASBSV	8	LED	5					
8	2	10-30 V DC	Orange			ASBSVB	8	LED	5					
8	2	10-30 V DC	Orange	M23, 19 Pole		ASBSVC	8	LED	5					
8	1	10-30 V DC	Black	M23, 19 Pole		ASBSVD	8	LED	W5					
8	2	60 V	Orange		PUR HF, Black	ASBV	8		5	242				5M, 10M
8	2	10-30 V DC	Orange		PUR HF, Black	ASBV	8	LED	5	242				5M, 10M
8	2	250 V	Grey		PUR/PVC, Black	ASBV	8		4-3	139			RS190M	1F
8	2	10-30 V DC	Yellow		PUR, Black	ASBV	8	LED	5	242			RS190M	1F
8	1	10-30 V DC	SS		PVC, Black	ASNBL	8	LED	5-4	320				5M, 10M, 15 M
8	2	10-30 V DC	SS		PVC, Black	ASNBV	8	LED	5	278				5M, 10M, 15 M

Table 7. Part Number Configurations for Micro M12 Distribution Boxes

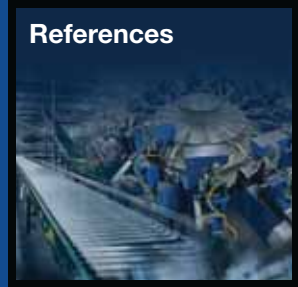

Be Certain with Belden

Part Number Configurations: Micro M12 Field Attachable Connectors (Male)

RSC 4 / DUO

Pins/ Poles	Thread Sizes	Male Straight Screw Terminals	Male 90° Screw Terminals	Male Straight Shieldable Screw Terminals	Male Straight Shieldable Spring Terminals	Male Straight Spring Terminals	Male Straight Screw Terminals Stainless Steel Hexagon Nut	Male 90° Screw Terminals Stainless Steel Hexagon Nut	Pins/ Thread Size	Dual Cable Connection
3	Ø 3.0-6.5 mm/SW 15	RSC	RSCW						3/7	
3	Ø 4.0-8.0 mm/SW 15	RSC	RSCW						3/9	
3	Ø 3.0-6.5 mm/SW 15					RSCQ			3/7	
3	Ø 4.0-8.0 mm/SW 15					RSCQ			3/9	
3	Ø 4.0-9.0 mm				RSCQS				3/9	
4	Ø 3.0-6.5 mm/SW 15	RSC	RSCW						4/7	
4	Ø 4.0-8.0 mm/SW 15	RSC	RSCW						4/9	
4	Ø 3.0-6.5 mm/SW 15					RSCQ			4/7	
4	Ø 4.0-8.0 mm/SW 15					RSCQ			4/9	
4	Ø 3.0-6.5 mm/SW 15						RSCN	RSCWN	4/7	
4	Ø 4.0-8.0 mm/SW 15						RSCN	RSCWN	4/9	
4	2 x 3 mm / 2 x 5 mm	RSC							4	DUO
4	2 x 3 mm / 2 x 5 mm						RSCN		4	DUO
4	Ø 4.0-9.0 mm			RSCS	RSCQS				4/9	
5	Ø 3.0-6.5 mm/SW 15	RSC	RSCW						5/7	
5	Ø 4.0-8.0 mm/SW 15	RSC	RSCW						5/9	
5	Ø 3.0-6.5 mm/SW 15						RSCN	RSCWN	5/7	
5	Ø 4.0-8.0 mm/SW 15						RSCN	RSCWN	5/9	
5	2 x 3 mm / 2 x 5 mm	RSC							5	DUO
5	Ø 4.0-9.0 mm			RSCS					5/9	
8	Ø 4.0-8.0 mm/SW 15	RSC	RSCW						8/9	
8	Ø 4.0-8.0 mm/SW 15						RSCN		8/9	
8	Ø 4.0-9.0 mm			RSCS					8/9	

Table 8.1. Part Number Configurations for Micro M12 Field Attachable Connectors

EXAMPLE: Receptacle

RSC 4/DUO = Micro M12, field attachable, male, straight with screw terminal connection, 4pole, thread size 2 x 3mm / 2 x 5mm with two cable connections.

Part Number Configurations: Micro M12 Field Attachable Connectors (Female)

RKC 4 / DUO

Pins/ Poles	Thread Sizes	Male Straight Screw Terminals	Male 90° Screw Terminals	Male Straight Shieldable Screw Terminals	Male Straight Shieldable Sprint Terminals	Male Straight Spring Terminals	Male Straight Screw Terminals Stainless Steel Hexagon Nut	Male 90° Screw Terminals Stainless Steel Hexagon Nut	Pins/Thread Size	Light Emit- ting Diodes	Dual Cable Connection
3	Ø 3.0-6.5 mm/SW 15	RKC	RKCW						4/3/7		
3	Ø 4.0-8.0 mm/SW 19	RKC	RKCW						4/3/9		
3	Ø 3.0-6.5 mm/SW 15					RKCQ			4/3/7		
3	Ø 4.0-8.0 mm/SW 19					RKCQ			4/3/9		
3	Ø 4.0-9.0 mm				RKCQS				4/3/9		
4	Ø 3.0-6.5 mm/SW 15	RKC	RKCW						4/7		
4	Ø 4.0-8.0 mm/SW 19	RKC	RKCW						4/9		
4	Ø 3.0-6.5 mm/SW 15	RKC	RKCW						4/7	LED	
4	Ø 4.0-8.0 mm/SW 19	RKC	RKCW						4/9	LED	
4	Ø 3.0-6.5 mm/SW 15					RKCQ			4/7		
4	Ø 4.0-8.0 mm/SW 19					RKCQ			4/9		
4	Ø 3.0-6.5 mm/SW 15						RKCN	RKCWN	4/7		
4	Ø 4.0-8.0 mm/SW 19						RKCN	RKCWN	4/9		
4	2 x 3 mm / 2 x 5 mm	RKC							4		DUO
4	2 x 3 mm / 2 x 5 mm						RKCN		4		DUO
4	Ø 4.0-9.0 mm			RKCS	RSCQS				4/7		
5	Ø 3.0-6.5 mm/SW 15	RKC	RKCW						5/7		
5	Ø 4.0-8.0 mm/SW 19	RKC	RKCW						5/9		
5	Ø 3.0-6.5 mm/SW 15						RKCN	RKCWN	5/7		
5	Ø 4.0-8.0 mm/SW 19						RKCN	RKCWN	5/9		
5	2 x 3 mm / 2 x 5 mm	RKC							5		DUO
5	Ø 4.0-9.0 mm			RKCS					5/9		
8	Ø 4.0-8.0 mm/SW 19	RKC	RKCW						8/9		
8	Ø 4.0-8.0 mm/SW 19						RKCN		8/9		
8	Ø 4.0-9.0 mm			RKCS					8/9		

Table 8.2. Part Number Configurations for Micro M12 Field Attachable Connectors (Female)

EXAMPLE: Field Attachable Connector

RKC 4/DUO = Micro M12, field attachable, female, straight with screw terminal connection, 4pole, thread size 2 x 3mm / 2 x 5mm with two cable connections.

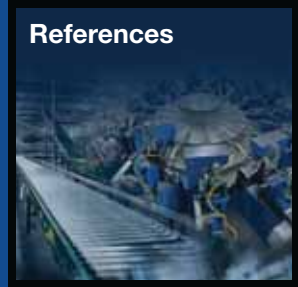

Be Certain with Belden

Part Number Configurations: Micro 1/2"-20 Cord Sets, Receptacles, and Inserts

RKT 4 U - 674 / 6F

Poles	Wires/ Gauge	Cable Type	Jacket	UL Rating	Color Code	Female Straight	Female 90°	Male Straight	Cable Code	Standard Cable Lengths (Feet and Meters)
3	3/20 AWG	PUR, Halogen Free	Black	AWM 21198	IEC	RKT 3 U		RST 3 U	226	2M, 5M, 10M
3	3/22 AWG	PVC	Yellow	AWM 2661	Automotive	RKT 3 U	RKWT 3 U	RST 3 U	618	6F, 12F, 15F, 20F
3	3/18 AWG	CPE	Yellow	SOOW	U.S.	RKT 3 U	RKWT 3 U	RST 3 U	619	6F, 12F, 15F, 20F
3	3/22 AWG	PUR	Yellow	AWM 20233	Automotive	RKT 3 U	RKWT 3 U	RST 3 U	664	6F, 12F, 15F, 20F
3	3/18 AWG	PVC	Yellow	AWM 2661	Automotive	RKT 3 U	RKWT 3 U	RST 3 U	688	6F, 12F, 15F, 20F
4	4/22 AWG	PVC	Yellow	AWM 2661	Automotive	RKT 4 U	RKWT 4 U	RST 4 U	674	6F, 12F, 15F, 20F
4	4/18 AWG	PVC	Yellow	AWM 2661	Automotive	RKT 4 U	RKWT 4 U	RST 4 U	689	6F, 12F, 15F, 20F
5	5/22 AWG	PVC	Yellow	AWM 20233	Automotive	RKT 5 U	RKWT 5 U	RST 5 U	673	6F, 12F, 15F, 20F
5	5/18 AWG	TPE	Yellow	PLTC	Automotive	RKT 5 U	RKWT 5 U	RST 5 U	755	6F, 12F, 15F, 20F

Table 9: Part Number Configurations for Micro 1/2"-20 Cord Sets

EXAMPLE: Single and Double Ended Cord sets

RKT 4 U-674/6F = Micro 1/2"-20, Single Ended Cordset, Female Straight, 4 Pole, PVC, Yellow Cable, AWM 2661, IEC Color Code, 6 Foot Cable Length. To build a Double Ended Cordset, add **RST** before **RKT**, e.g. **RST 4 U-RKT 4 U-674/6F**. **NOTE:** Cable lengths for double-ended cord sets vary from the chart listing above - see actual technical specifications for part number in question.

NOTE: Areas without a part number identifier are considered to be a special order.

RKF 4U / 1F

Poles	Panel Mount	Threads	Voltage Rating	Color Code	Female Straight	Male Straight	Lead Length
3	Front	1/4-18 NPT	250 V	Automotive	RKF 3 U	RSF 3 U	1F
3	Insert		240 V			RSE 3 U	
4	Front	1/4-18 NPT	250 V	Automotive	RKF 4 U	RSF 4 U	1F
4	Insert		240 V			RSE 4 U	
5	Front	1/4-18 NPT	250 V	Automotive	RKF 5 U	RSF 5 U	1F
5	Insert		60 V			RSE 5 U	

Table 10: Part Number Configurations for Micro 1/2"-20 Receptacles

EXAMPLE: Receptacles and Inserts

RSF 4U/1F = Micro 1/2"-20, receptacle, male, straight, 4-pole, front mount with 1/4-18 NPT threads, 250 V voltage rating, Automotive color code with 1 foot leads.

Part Number Configurations: Micro 1/2"-20 Field Attachable Connectors

RSCW 3U/9

Pins/ Poles	Thread Sizes	Threads	Male Straight Screw Termi- nals	Female Straight Screw Termi- nals	Male 90° Screw Terminals	Female 90° Screw Terminals
3	3.0-6.5 mm	PG 7	RSC 3U/7	RKC 3U/7	RSCW 3U/7	RKCW 3U/7
3	4.0-8.0 mm	PG 9	RSC 3U/9	RKC 3U/9	RSCW 3U/9	RKCW 3U/9

Table 11: Part Number Configurations for Micro 1/2"-20 Field Attachable Connectors

EXAMPLE: Receptacles

RSCW 3U/9 = Micro 1/2"-20, field Attachable connector, male, 90°, 3-pole, PG9 threads.

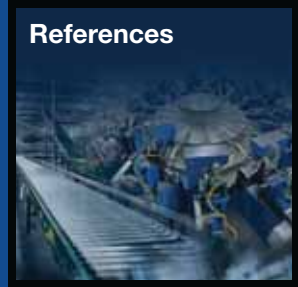

Be Certain with Belden

Part Number Configurations: Pico M8, Cord Sets

RKMWV / LED A 3 - 06 / 2M

Poles	Type	Wires/ Gauge	Cable Type	Jacket	UL Rating	Color Code	Female Straight	Female 90°	Male Straight	Male 90°	Light Emit- ting Diode	Pins	Cable Code	Standard Cable Lengths (Feet and Meters)
3	Coupling Nut	3/22 AWG	PVC	Orange	AWM 2464	IEC	RKMV	RKMWV	RSMV	RSMWV		3	06	2M, 5M, 10M
3	Coupling Nut	3/22 AWG	PVC	Orange	AWM 2464	IEC		RKMWV			LED A	3	06	2M, 5M, 10M
3	Snap-In	3/22 AWG	PVC	Orange	AWM 2464	IEC	RKM	RKMW				3	06	2M, 5M, 10M
3	Snap-In	3/22 AWG	PVC	Orange	AWM 2464	IEC		RKMW			LED A	3	06	2M, 5M, 10M
3	Coupling Nut	3/22 AWG	PUR, Halogen Free	Black	AWM 21198	IEC	RKMV	RKMWV	RSMV	RSMWV		3	224	2M, 5M, 10M
3	Snap-In	3/22 AWG	PUR, Halogen Free	Black	AWM 21198	IEC	RKM	RKMW				3	224	2M, 5M, 10M
3	Snap-In	3/22 AWG	PUR, Halogen Free	Black	AWM 21198	IEC		RKMW			LED A	3	224	2M, 5M, 10M
3	Coupling Nut	3/24 AWG	PUR, Halogen Free	Grey	AWM 20233	IEC	RKMVS	RKMWVS				3	357	5M
4	Coupling Nut	4/24 AWG	PVC	Orange	AWM 2464	IEC	RKMV	RKMWV	RSMV	RSMWV		4	07	2M, 5M, 10M
4	Snap-In	4/24 AWG	PVC	Orange	AWM 2464	IEC	RKM	RKMW				4	07	2M, 5M, 10M
4	Coupling Nut	3/22 AWG	PUR, Halogen Free	Black	AWM 21198	IEC		RKMWV			LED A	4	224	2M, 5M, 10M
4	Coupling Nut	4/22 AWG	PUR, Halogen Free	Black	AWM 21198	IEC	RKMV	RKMWV	RSMV	RSMWV		4	225	2M, 5M, 10M
4	Snap-In	4/22 AWG	PUR, Halogen Free	Black	AWM 21198	IEC	RKM	RKMW				4	225	2M, 5M, 10M
4	Coupling Nut	4/24 AWG	PUR, Halogen Free	Grey		IEC	RKMVS	RKMWVS				4	358	5M
8	Snap-In	8/26 AWG	PUR, Halogen Free	Black	AWM 21198	IEC	RKMV					8	354	2M, 5M, 10M
8	Snap-In	8/26 AWG	PUR, Halogen Free	Black	AWM 21198	IEC			RSM			8	354	2M, 5M, 10M

Table 12: Part Number Configurations for Pico M8 Cord Sets

EXAMPLE: Single and Double Ended Cord sets

RKMWV/LED A 3-06/2M = Pico M8, Single Ended Cordset, Female 90°, 3 Pole, PVC, Orange Cable, AWM 2464, IEC Color Code, 2 Meter Cable Length. To build a Double Ended Cordset, add **RSMV** before **RKMWV/LED**, e.g. **RSMV 3-RKMWV 3-224/2M**. **NOTE:** Double Ended Cordsets and Cable lengths vary from the chart listing above - see actual technical specifications for part number in question.

NOTE: Areas without a part number identifier are considered to be a special order.

Part Number Configurations: Pico M8, Distribution Boxes

ASBM 4 / LED 3 - 343 / 5M



Ports	Signals Per Port	Voltage Rating	Housing Color	On-Board Connector or Integrated Control Cable Type	M8 Distribution Box	Number of Ports	Light Emitting Diode	Port Pins	Control Cable Code	Cable Lengths
4	1	10-30 V DC	Black	On-Board M12 Connector	ASBSM	4	LED	3		
4	1	10-30 V DC	Black	PUR, Halogen Free, Black	ASBM	4	LED	3	343	5M, 10M, 15M
4	1	10-30 V DC	Orange	On-Board M12 Connector	SBS	4	LED	3		
6	1	10-30 V DC	Black	On-Board M12 Connector	ASBSM	6	LED	3		
6	1	10-30 V DC	Black	PUR, Halogen Free, Black	ASBM	6	LED	3	344	5M, 10M, 15M
8	1	10-30 V DC	Black	On-Board M12 Connector	ASBSM	8	LED	3		
8	1	10-30 V DC	Black	PUR, Halogen Free, Black	ASBM	8	LED	3	345	5M, 10M, 15M
8	1	10-30 V DC	Orange	PUR, Halogen Free, Black	SB	8	LED	3	333	5M, 10M
10	1	10-30 V DC	Black	On-Board M12 Connector	ASBSM	10	LED	3		
10	1	10-30 V DC	Black	PUR, Halogen Free, Black	ASBM	10	LED	3	346	5M, 10M, 15M
12	1	10-30 V DC	Black	PUR, Halogen Free, Black	ASBM	12	LED	3	347	5M, 10M, 15M

Table 13: Part Number Configurations for Pico M8 Distribution Boxes

EXAMPLE: Distribution Box

ASBM 4/LED 3-343/5M = Pico M8, Distribution Box, 4 Port with Light Emitting Diodes (LED) and 5 meter PUR, halogen free black control cable.

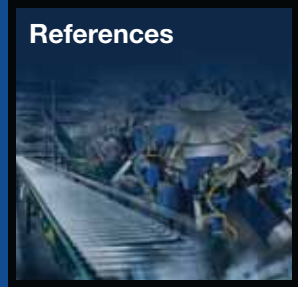

Be Certain with Belden

Part Number Configurations: Pico M8, Receptacles and Field Attachable Connectors

RSMF 3 / 0.5M

Poles	Panel Mount	Mounting	Threads	Voltage Rating	Color Code	Female Straight	Male Straight	Pins	Lead Length
3	Rear	PCB	M10 x 1	60 V	IEC	RKMHL	RSMHL	3/S 5.5	
4	Rear	PCB	M10 x 1	60 V	IEC	RKMHL	RSMHL	4/S 5.5	
3	Front		M8 x 0.5	60 V	IEC	RKMF	RSMF	3	0.5 M
4	Front		M8 x 0.5	60 V	IEC	RKMF	RSMF	4	0.5 M
8	Front		M8 x 0.5	32 V	IEC		RSMF	8	0.5 M

Table 14: Part Number Configurations for Pico M8 Receptacles

EXAMPLE: Receptacle

RSMF 3/0.5M = Pico M8, Receptacle, Male Straight, 3 Pins with 0.5 meter leads.

NOTE: Areas without a part number identifier are considered to be a special order.

RKMC 4

Poles	Screw Joint	Male Straight Solder Connections	Male 90° Solder Connections	Male Straight Screw Terminals	Female Straight Solder Connections	Female 90° Solder Connections	Female Straight Screw Terminals	Pins
3	Ø 3.5 - 5.0 mm	RSMC	RSMCW	RSMCK	RKMC	RKMCW	RKMCK	3
4	Ø 3.5 - 5.0 mm	RSMC	RSMCW	RSMCK	RKMC	RKMCW	RKMCK	4

Table 15: Part Number Configurations for Pico M8 Field Attachable Connectors

EXAMPLE: Field Attachable Connector

RKMC 4 = Pico M8, Field Attachable Connector, Female Straight with Ø 3.5 - 5.0 mm Screw Joint.

NOTE: Areas without a part number identifier are considered to be a special order.

Cable Index

Cable No.	Conductors	Gauge	Material	Jacket Color	Voltage Rating	UL	Color Code	Outside Diameter
06	3	3/22 AWG	PVC	Orange	300 V	AWM 2464	IEC	.197" / Ø 5.0mm
07	4	4/24 AWG	PVC	Orange	300 V	AWM 2464	IEC	.197" / Ø 5.0mm
56	5	5/22 AWG	PVC	Orange	300 V	AWM 2464	IEC	.224" / Ø 5.7mm
138	9	8x 0.34mm ² , 1x 0.75mm ²	PUR/PVC	Black	300 V		IEC	.354" / Ø 9.0mm
139	17	16x 0.34mm ² , 1x 0.75mm ²	PUR/PVC	Black	300 V		IEC	.425" / Ø 10.8mm
182	4	4/22 AWG	PVC, Shielded	Orange	300 V		IEC	.217" / Ø 5.5mm
183	5	5/22 AWG	PVC, Shielded	Orange	300 V		IEC	.236" / Ø 6.0mm
184	8	8/24 AWG	PVC, Shielded	Orange	300 V		IEC	.260" / Ø 6.6mm
224	3	3/22 AWG	PUR, Halogen Free	Black	300 V	AWM 21198	IEC	.169" / Ø 4.3mm
225	4	4/22 AWG	PUR, Halogen Free	Black	300 V	AWM 21198	IEC	.185" / Ø 4.7mm
226	3	3/20 AWG	PUR, Halogen Free	Black	300 V	AWM 21198	IEC	.181" / Ø 4.6mm
228	5	5/20 AWG	PUR, Halogen Free	Black	300 V	AWM 21198	IEC	.213" / Ø 5.4mm
242	19	3X1mm ² , 16x 0.50mm ²	PUR, Halogen Free	Black	300 V	AWM 21198	IEC	.457" / Ø 11.6mm
251	4	4/22 AWG	PUR, Halogen Free, Weld Spark Proof	Orange	300 V	AWM 21198	IEC	.185" / Ø 4.7mm
256	4	3X1mm ² , 8x 0.50mm ²	PUR, Halogen Free	Black	300 V	AWM 21198	IEC	.366" / Ø 9.3mm
259	5	5x 0.50mm ²	PUR, Halogen Free, Weld Spark Proof	Orange	300 V	AWM 21198	IEC	.217" / Ø 5.5 mm
260	3	3/22 AWG	PUR, Halogen Free, Weld Spark Proof	Orange	300 V	AWM 21198	IEC	.177" / Ø 4.5mm
265	4	4/22 AWG	PUR, Halogen Free	Grey	300 V	AWM 21198	IEC	.185" / Ø 4.7mm
268	6	6/22 AWG	PUR, Halogen Free, Weld Spark Proof	Orange	300 V	AWM 21198	IEC	.236" / Ø 6.0mm
278	8	3x 1mm ² , 16x 0.50mm ²	PVC	Black	300 V	AWM 2654	IEC	.457" / Ø 11.6mm
282	8	7/24 AWG	PUR, Halogen Free, Shielded	Black	300 V	AWM 21198	IEC	.236" / Ø 6.0mm
288	4	4/22 AWG	PVC, Shielded	Black	300 V	AWM 21198	IEC	.217" / Ø 5.5mm
298	5	5/22 AWG	PUR, Halogen Free, Shielded	Black	300 V	AWM 21198	IEC	.236" / Ø 6.0mm
299	8	8/24 AWG	PUR, Halogen Free, Shielded	Black	300 V	AWM 21198	IEC	.260" / Ø 6.6mm
320	11	8x 0.34mm ² , 3x 0.75mm ²	PVC	Black	300 V	AWM 2654	IEC	.374" / Ø 9.5mm
328	7	4x 0.34mm ² , 3x 0.75mm ²	PUR, Halogen Free	Black	300 V	AWM 21198	IEC	.268" / Ø 6.8mm
330	9	6x 0.34mm ² , 3x 0.75mm ²	PUR, Halogen Free	Black	300 V	AWM 21198	IEC	.299" / Ø 7.6mm
331	11	8x 0.34mm ² , 3x 0.75mm ²	PUR, Halogen Free	Black	300 V	AWM 21198	IEC	.315" / Ø 8.0mm
332	15	3X1mm ² , 12x 0.50mm ²	PUR, Halogen Free	Black	300 V	AWM 21198	IEC	.358" / Ø 9.1mm
333	10	2x0.50mm ² , 8x 0.34mm ²	PUR, Halogen Free	Black	300 V	AWM 21198	IEC	.347" / Ø 8.8mm
337	6	6/22 AWG	PUR, Halogen Free	Black	300 V	AWM 21198	IEC	.236" / Ø 6.0mm
343	6	6/24 AWG	PUR, Halogen Free	Black	300 V	AWM 21198	IEC	.201" / Ø 5.1mm
344	8	8/24AWG	PUR, Halogen Free	Black	300 V	AWM 21198	IEC	.236" / Ø 6.0mm
345	10	10/24AWG	PUR, Halogen Free	Black	300 V	AWM 21198	IEC	.248" / Ø 6.3mm
346	12	12/24AWG	PUR, Halogen Free	Black	300 V	AWM 21198	IEC	.252" / Ø 6.4mm
347	14	14/24AWG	PUR, Halogen Free	Black	300 V	AWM 21198	IEC	.284" / Ø 7.2mm
348	12	2x 0.25mm ² /10x 0.14mm ²	PUR, Halogen Free	Black	300 V	AWM 21198	IEC	.236" / Ø 6.0mm
354	8	8/26 AWG	PUR, Halogen Free	Black	300 V	AWM 21198	IEC	.197" / Ø 5.0mm
357	3	3/24 AWG	PUR, Halogen Free	Grey	300 V	AWM 20233	IEC	.181" / Ø 4.6mm
358	4	4/24 AWG	PUR, Shielded	Grey	300 V		IEC	.205" / Ø 5.2mm
601	3	3/18 AWG	PVC	Yellow	300 V	AWM 2661	IEC (AC)	.290" / Ø 7.4mm
602	4	4/18 AWG	PUR	Yellow	300 V	AWM 20233	IEC	.230" / Ø 5.9mm

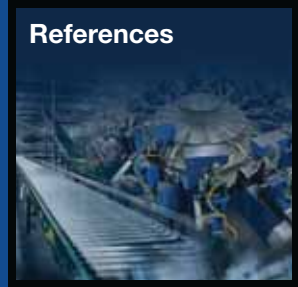

Be Certain with Belden

Cable Index

Cable No.	Conductors	Gauge	Material	Jacket Color	Voltage Rating	UL	Color Code	Outside Diameter
603	2	2/18 AWG	PVC	Yellow	300 V	AWM 2661	IEC	.290" / Ø 7.4mm
610	3	3/22 AWG	PUR	Yellow	300 V	AWM 20233	IEC	.190" / Ø 4.8mm
612	5	5/22 AWG	PVC	Yellow	300 V	AWM 2661	IEC	.210" / Ø 5.3mm
618	3	3/22 AWG	PVC	Yellow	300 V	AWM 2661	Automotive	.180" / Ø 4.6mm
619	3	3/18 AWG	CPE	Yellow	600 V	SOOW	U.S.	.370" / Ø 9.4mm
622	7	7/16 AWG	PVC	Yellow	600 V	STOW	U.S.	.560" / Ø 14.2mm
623	9	9/16 AWG	PVC	Yellow	600 V	STOW	U.S.	.660" / Ø 16.8mm
627	8	8/24 AWG	PVC	Black	300 V	AWM 2661	IEC	.250" / Ø 6.4mm
632	3	3/22 AWG	PVC	Yellow	300 V	AWM 2661	IEC	.190" / Ø 4.8mm
633	4	4/22 AWG	PVC	Yellow	300 V	AWM 2661	IEC	.190" / Ø 4.8mm
635	4	4/22 AWG	PVC, Shielded	Yellow	300 V	AWM 2661	IEC	.230" / Ø 5.9mm
637	4	4/18 AWG	TPE	Yellow	300 V	PLTC	IEC	.280" / Ø 7.1mm
643	4	4/22 AWG	TPE	Yellow	300 V	PLTC	IEC	.246" / Ø 6.3mm
644	5	5/22 AWG	PUR	Yellow	300 V	AWM 20233	IEC	.210" / Ø 5.3mm
645	3	3/18 AWG	PUR	Yellow	300 V	AWM 20233	IEC	.220" / Ø 5.6mm
649	7	7/18 AWG	PUR	Yellow	300 V	AWM 20233	U.S.	.270" / Ø 6.9mm
650	8	8/18 AWG	PUR	Yellow	300 V	AWM 20233	U.S.	.292" / Ø 7.4mm
651	9	9/18 AWG	PUR	Yellow	300 V	AWM 20233	U.S.	.313" / Ø 8.0mm
652	10	10/18 AWG	PUR	Yellow	300 V	AWM 20233	U.S.	.340" / Ø 8.6mm
654	12	12/18 AWG	PUR	Yellow	300 V	AWM 20233	U.S.	.354" / Ø 9.0mm
664	3	3/22 AWG	PUR	Yellow	300 V	AWM 20233	Automotive	.190" / Ø 4.8mm
669	19	19/18 AWG	PUR	Yellow	300 V	AWM 20233	Numeric	.489" / Ø 12.4mm
673	5	5/22 AWG	PVC	Yellow	300 V	AWM 20233	Automotive	.210" / Ø 5.3mm
674	4	4/22 AWG	PVC	Yellow	300 V	AWM 2661	Automotive	.190" / Ø 4.8mm
676	12	12/18 AWG	PUR	Yellow	300 V	AWM 20233	Numeric	.390" / Ø 9.9mm
678	2	2/16 AWG	PVC	Yellow	600 V	STOW	U.S.	.375" / Ø 9.5mm
679	4	4/22 AWG	PUR	Yellow	300 V	AWM 20233	IEC	.190" / Ø 4.8mm
688	3	3/18 AWG	PVC	Yellow	300 V	AWM 2661	Automotive	.290" / Ø 7.4mm
689	4	4/18 AWG	PVC	Yellow	300 V	AWM 2661	Automotive	.290" / Ø 7.4mm
696	6	6/16 AWG	PVC	Yellow	600 V	STOW	U.S.	.560" / Ø 14.2mm
697	6	6/18 AWG	PVC	Yellow	600 V	STOW	U.S.	.502" / Ø 12.8mm
698	8	8/16 AWG	PVC	Yellow	600 V	STOW	U.S.	.585" / Ø 14.9mm
699	10	10/16 AWG	PVC	Yellow	600 V	STOW	U.S.	.660" / Ø 16.8mm
724	12	12/16 AWG	TPE	Yellow	600 V	SE00W	U.S.	.690" / Ø 17.5mm
728	12	11/18 AWG	TPE	Yellow	600 V	SE00W	IEC	.596" / Ø 15.1mm
731	3	3/18 AWG	TPE	Yellow	300 V	PLTC	IEC	.284" / Ø 7.2mm
738	3	3/16 AWG	TPE	Yellow	600 V	SE00W	U.S.	.390" / Ø 9.9mm
739	4	4/16 AWG	TPE	Yellow	600 V	SE00W	U.S.	.415" / Ø 10.5mm
741	3	3/16 AWG	TPE	Yellow	600 V	SE00W	Automotive	.390" / Ø 9.9mm
742	5	5/16 AWG	TPE	Yellow	600 V	SE00W	Automotive	.495" / Ø 12.6mm
755	5	5/18 AWG	TPE	Yellow	300 V	PLTC	Automotive	.333" / Ø 8.5mm
777	5	5/16 AWG	TPE	Yellow	600 V	SE00W	U.S.	.495" / Ø 12.6mm
794	5	5/18 AWG	TPE	Yellow	300 V	PLTC	IEC	.304" / Ø 7.7mm

International Protection Classes According to DIN EN 60529 (IEC 529/VDE 047 T1)

The International Electrotechnical

Commission (IEC) is the international standards and conformity assessment body for all fields of electro technology.

IEC International Standard 60529 (Edition 2.1: 2001-02) is a classification of degrees of protection provided by enclosures as a system for specifying the enclosures of electrical equipment on the basis of the degree of protection provided by the enclosure.

Ingress Protection as it relates to sealing against the entry of solid and liquid objects. Complete details of this standard can be obtained from the IEC. This uniform and widely

acknowledged classification system provides equipment designers and specifying agents with a convenient and reliable method of comparing relative levels of sealing between competing (connector) products. In its simplest form, the classification system consists of the letters "IP" followed by two separate digits, which denote increasingly greater sealing from solid objects and from water.

For example, a product rated as being sealed to IP55 will provide some degree of protection from penetration by dust and a jet spray of water, but it would not be expected to completely seal against all dust or being immersed in water.

With an IP67 rating a product will be "dust tight" and remain completely sealed when immersed in water for 30 minutes. The chart below clearly defines levels of IP ratings and should be used as a guide during the specification and design process.

Protection Against Solid Foreign Objects Penetrating the Product.

IP







Ingress Protection

6

First Index Figure
Protection Against
Foreign Objects

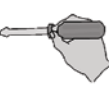
7

Second Index Figure
Protection Against Water



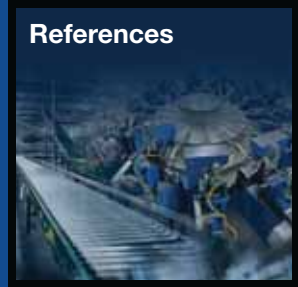





1st Index Number	Icon	Brief Description	Definition
0		No protection	Not applicable
1		Protected against solid foreign objects of 50 mm Ø and >	The object probe, sphere of 50 mm Ø, shall not fully penetrate**
2		Protected against solid foreign objects of 12.5 mm Ø and >	The object probe, sphere of 12.5 mm Ø, shall not fully penetrate**
3		Protected against solid foreign objects of 2.5 mm Ø and >	The object probe, sphere of 2.5 mm Ø, shall not fully penetrate**
4		Protected against solid foreign objects of 1.0 mm Ø and >	The object probe, sphere of 1.0 mm Ø, shall not fully penetrate**
5		Dust protected	Ingress of dust is not totally prevented, but dust shall not penetrate in a quantity to interfere with satisfactory operation of the apparatus or to impair safety.
6		Dust tight	No ingress of dust



Be Certain with Belden

International Protection Classes According to DIN EN 60529 (IEC 529/VDE 047 T1)

Protection Class - Protection Against Ingress of Water with Adverse Effects.	IP Ingress Protection	6 First Index Figure Protection Against Foreign Objects	7 Second Index Figure Protection Against Water
---	---------------------------------	---	--

1st Index Number	Icon	Brief Description	Definition
0		No protection.	Not applicable.
1		Protected against vertically falling water drops.	Vertically falling drops shall have no harmful effects.
2		Protected against vertically falling water drops when the enclosure is tilted up 15°.	Vertically falling drops shall have no harmful effects when the enclosure is tilted at an angle up to 15° on either side of the vertical.
3		Protected against spraying water.	Water sprayed at an angle up to 60° on either side of the vertical shall have no harmful effects.
4		Protected against splashing water.	Water splashed against the enclosure from any direction shall have no harmful effect.
5		Protected against water jets.	Water projected in jets against the enclosure from any direction shall have no harmful effects.
6		Protected against powerful water jets	Water projected in powerful jets against the enclosure shall have no harmful effects.
7		Protected against the effects of temporary immersion in water.	Ingress of water in quantities causing harmful effects shall not be possible when the enclosure is temporarily immersed in water under standardized conditions of pressure and time.
8		Protected against the effects of continuous immersion in water.	Ingress of water in quantities causing harmful effects shall not be possible when the enclosure is continuously immersed in water under the conditions which shall be agreed between the manufacturer and user, but which are more severe than for numeral 7, above.
9K		Protected against water from high-pressure / steam jet cleaners.	Water directed against the enclosure from any direction under extremely high pressure and must have no adverse effects.

Glossary of Terms

A

Abrasion Resistance

The ability of wire or cable to resist wear and tear to the surface.

AC (Alternating Current)

See Alternating Current.

ACR (Attenuation Cross Talk Ratio)

Attenuation Cross Talk Ratio – the difference between attenuation and cross talk measured in decibel at a given frequency.

AF (Audio Frequency)

AM (Amplitude Modulation)

Alternating Current (AC or a.c.)

Electrical current, which changes magnitude and direction in a regular periodic way and is often described by the formula $I(t) = I_0 \sin(\omega t + \phi)$, where I_0 is the peak value or amplitude of the current, ω is the angular frequency, ϕ is the phase constant and $(\omega t + \phi)$ is called the phase of the current.

American Society for Testing and Materials

See ASTM.

Ambient Temperature

The temperature of a medium (gas or liquid) surrounding an object.

American Wire Gauge (AWG)

The U.S. standard system to specify size of electrical wiring.

AMP (A) (Ampere)

A unit of measure for electrical current.

Ampere (A)

The unit of current. One ampere is the current flowing through one ohm of resistance at one volt potential.

Amplitude Modulation (AM)

ANSI (American National Standards Institute)

Appliance Wiring Material (AWM). UL designation for cable intended for use in the appliance wiring industry.

Armored Cable

A cable provided with a wrapping of metal providing for mechanical protection.

ASTM (American Society for Testing and Materials)

Acronym for American Society for Testing and Materials – a standards organization, which suggests test methods, definitions or practices.

Audio Frequency (AF) – 20 – 20,000 cycles per second

AUTO

Automotive Industry Wiring Color Code for conductors.

AWG (American Wire Gauge)

A numerical standard used to refer to the diameter cross-sectional area of a wire. Smaller numbers refer to larger cross sectional areas. Is sometimes referred to as the Brown and Sharpe (B&S) wire gauge.

B

Binder

A spirally wrapped tape or thread used for holding assembled cable components in place awaiting subsequent manufacturing operations.

BNC (Bayonet Neil Concelman)

A coaxial connector used exclusively in video and RF applications.

Braid

A metal mesh or screen material, usually copper, which is used in a cable to shield against electrical interference and reinforces the cable jacket against damage.

Bridge Rectifier

An electrical device made up of four diodes, performing the function of full wave rectification (converts the full AC sine wave to DC).

C

Cable

Either a stranded conductor with or without insulation and other coverings (single conductor cable), or a combination of conductors insulated from one another (multiple conductor cable).

Capacitor

An electronic device, which can be used to store an electric charge or to allow alternating current to flow. The ideal capacitor will not allow steady state or DC current to flow. The capacitor is used in many applications such as transient suppression, electrical noise filtering, timing circuits, etc.

CATV (Community Antenna Television)

CCTV (Closed Circuit Television)

CEC (Canadian Electrical Code)
Canadian version of USNEC.

Color Code

Used to identify wires or circuits by color, utilizing solid colors, tracers, braids, and other surface printing.

Conductivity

The ability of a material to allow electrons to flow, measured by the current per unit of voltage applied. It is the reciprocal of resistivity.

Conductor

A material that can easily conduct the flow of electrical current. Metals are considered to be good conductors for carrying electrical current.

Connector

A device used to provide rapid connect or disconnect for electrical cable and wire terminations.

Connector Insert

Insulating device that holds the contacts in their proper location.

Contact

The parts of a connector that carries the electrical current through the circuit.

Contact Holder

Insulating device that holds the contacts in their proper position.

Control Cable

A term sometimes used to describe the cable that runs between the PLC and a distribution box (Lumberg ASB or ZV product).

Cord

A small and flexible insulated cable.

CPE (Chlorinated Polyethylene)

A flexible synthetic rubber material with high tear strength and provides good resistance to most inorganic chemicals. It is inherently difficult to ignite.

CPU (Central Processing Unit)

Creepage

Refers to the conduction of electricity across the surface of a dielectric.

Crimp Termination

A connection, in which a metal sleeve is secured to a conductor by mechanically crimping the sleeve with pliers, presses or automated crimping machines.

CRT (Cathode Ray Tube)

CSA (Canadian Standards Association)

The Canadian equivalent to the Underwriters Laboratories organization.

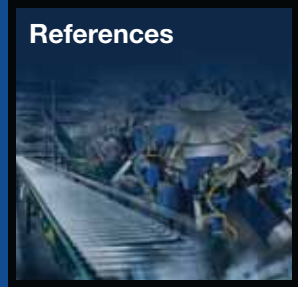

Be Certain with Belden

Glossary of Terms

Current (I)

This is the rate in which electricity is transferred. Practical unit is the ampere, which represents the transfer of one coulomb per second. In a simple circuit, current (I) produced by a cell or electromotive force (E) when there is an external resistance (R) and internal resistance (r) is: $I = E / (R + r)$.

Current Carrying Capacity

The maximum current a conductor can safely carry without exceeding its insulation and jacket temperature limitations.

Current Surge

This is a short-term (transient) condition causing a larger than normal amount of current to flow through a conductor. A current surge can often cause damage to an electrical device if it is not properly protected.

Cut-Through Resistance

The ability of a material to withstand mechanical pressure, usually a sharp edge or small bend radius, without separation.

D

dB (Decibel)

Used to express acoustical power.

DC (Direct Current)

Electrical current that flows in one direction only.

Dielectric Strength

The voltage that an insulator can withstand before breakdown occurs. Usually expressed as a voltage gradient (such as volts per mil).

DIN (Deutsches Institut für Normung)

The German Standardization Institute.

DIN 43650

A German standard, stating the characteristics and requirements of connectors for magnetic valves used in hydraulics and pneumatics.

Diode

This is a solid-state electronic component, which will allow current to flow in only one direction, similar to a check valve used in hydraulic or pneumatic applications. The diode is used in applications such as transient suppression, power supply circuits etc.

Direct Current (DC)

The flow of electrical current in one direction.

Drain Wire

In a cable, the bare wire laid under a metallic foil or braid and is used as a ground connection.

Distribution Box

Sometimes referred to as Junction or Multi Box is designed to distribute a signal to multiple locations.

E

E

The symbol for Voltage or electromotive force.

Earth

The British term for zero voltage reference.

EFP (Electronic Field Production)

Video production, non-news production, done outside the studio.

EIA

Electronic Industries Association – formerly RMA or RETMA.

Electronic Magnetic Sensor

This is a solid-state device, which is used to sense a magnetic field.

EMF (Electromotive Force)

Voltage

EMI (Electromagnetic Interference)

ENG (Electronic News Gathering)

EPDM (Ethylenepropylenediene Monomer)

A material with good electrical insulating qualities.

EPR (Ethylenepropylene Copolymer Rubber)

A material with good electrical insulating qualities.

ETP (Electrolytic Tough Pitch)

A copper refining process.

EU (European Union Directives)

A copper refining process.

EV (Electron Volt)

Extruded Cable with conductors that are uniformly insulated and formed by applying a homogeneous insulation material in a continuous extrusion process.

F

f

The symbol for Frequency.

FAS

Fire Alarm and Signal Cable – cable designation.

FEP (Fluorinated Ethylenepropylene)

A thermoplastic material with good electrical insulating properties and chemical and heat resistance.

Fillers

Non-conducting components cabled with the insulated conductors or optical fibers to impart roundness, flexibility, tensile strength, or a combination of all three, to the cable.

FM (Frequency Modulation)

G

Gauss (Ga)

Unit of measure for magnetic flux density.

GHz (Gigahertz)

A unit of frequency equal to 1 billion (10⁹) hertz.

Ground (GND)

An electrical connection between a circuit and earth.

Ground Loop

A completed circuit between shielded pairs of a multiple pair created by random contact between shields. Also, is an undesirable circuit condition in which interference is created by ground currents when grounds are connected at more than one point.

Ground Potential

A circuit, terminal or chassis is said to be at ground potential when it is used as a reference point for other potentials in the system.

H

Hertz (Hz)

The unit of measure for frequency in cycles per second.

HF (High Frequency)

The band from 3 to 30 MHz in the radio spectrum.

Hygroscopic

Capable of absorbing moisture from the air.

I

I²R

Formula for power in watts, where I = current in amperes, and R = resistance in ohms.

ICEA (Insulated Cable Engineers Association)

IEC (International Electrotechnical Commission)

Glossary of Terms

European Standardization Agency.

IF (Intermediate – Frequency)

IFB (Interrupted Feed Back)

Input

A signal (or power) which is applied to a piece of electrical apparatus or the terminals on the apparatus to which a signal or power is applied.

Insertion Force

The force required to insert a contact into the mating contact.

Insulation

A material having good dielectric properties that is used to separate close electrical components, such as cable conductors and circuit components.

Insulation Resistance

The resistance measured in Ohms at a designated voltage between two or more conductors separated by the insulation whose resistance is being measured.

IP (Ingress Protection)

Rating of protection.

IP65

Dust tight. An environmental protection for a type of enclosure - according to the German Standard DIN 40050. Provides protection against water spray from all directions at 43 PSI through a 12mm nozzle.

IP67

Protected against the effects of temporary immersion in water (30 minutes – depth of 1 meter).

IP68

Protected against the effects of continuous immersion in water at a pressure specified by the manufacturer. Lumberg's requirement is 10 Bar (143 PSI) at 24 hours.

Irradiation

Relating to a cable jacket where the material is exposed to high-energy emissions for the purpose of cross-linking the molecular structure.

IRS (Ignition Radiation Suppression)

ISO (International Standards Organization)

J

Jacket

A rubber or plastic covering applied over the primary insulation, braids, shields, and cable components.

K

KPSI

Tensile strength expressed in thousands of pounds per square inch.

KV (Kilovolt)

The measurement of Kilovolt=1000 volts

KVA (Kilovolt ampere)

KW (Kilowatt)

L

LED (Light Emitting Diode)

A solid-state device, which emits light when current, passes through it.

LF (Low Frequency)

Line Voltage

The value of the potential existing on a supply or power line.

Load

A device that consumes power from a source and uses that power to perform a function.

M

M (Mutual Inductance)

The alpha character for Mutual Inductance.

mA (Mill Ampere)

One thousandth of an ampere.

MATV (Master Antenna Television)

MF (Microfarad)

One millionth of a farad.

MH (Megahertz)

A unit of frequency equal to one million hertz.

Moisture Resistance

The ability of a material to resist absorbing moisture from the air or from water when immersed.

Molded Plug

A connector over molded onto either end of a cord or cable.

MOV (Metal Oxide Varistor)

A solid-state device used to suppress voltage surges/spikes.

MSHA (Mine Safety and Health Administration)

Multibox

Sometimes referred to as Distribution or Junction Box -

designed to distribute a signal to multiple locations.

mV (Millivolt)

One thousandth of a volt.

mW (Milliwatt)

One thousandth of a watt.

Mylar

The DuPont trademark for polyester film.

N

NA (Numerical Aperture)

A measure of the angular acceptance for a fiber.

National Electrical Code (NEC)

A set of regulations governing construction and installation of electrical wiring and apparatus in the United States, established by the American National Board of Fire Underwriters.

NEMA (National Electrical Manufacturers Association) – **sets the standards for industrial control equipment.**

NEMA 4

Intended for indoor or outdoor use primarily to provide a degree of protection against windblown dust and rain, splashing water and hose directed water.

NEMA 6

Intended for indoor or outdoor use primarily to provide a degree of protection against entry of water during occasional temporary submersion at a limited depth.

NEMA 6P

Intended for indoor or outdoor use primarily to provide a degree of protection against entry of water during occasional temporary submersion at a limited depth. (Requirement; 6 ft. of water for 24 hours).

Neoprene

Is a synthetic rubber with good resistance to oil, chemical and flame. Also referred to as polychloroprene.

Nitrile (Buna)

This is a rubber like manmade material used extensively in gasket and sealing applications.

Nm (Nanometer)

One billionth (10⁻⁹) of a meter.

Noise

In a cable or circuit, any extraneous electrical signal that tends to interfere with the signal normally present in or passing through the system.

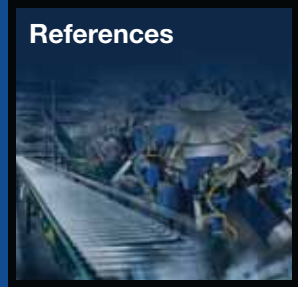

Be Certain with Belden

Glossary of Terms

Normally Closed

The state of the output or switch is ON with no external influence.

Normally Open

The state of the output or switch is OFF with no external influence NPN (Sinking) Acronym used to describe the polarization of a bipolar junction transistor (BJTs). Also associated with a sinking output.

NPN (Sinking)

Acronym used to describe the polarization of a bipolar junction transistor (BJTs). Also associated with a sinking output.

NPN Output

Transistor output that switches the common or negative voltage to the load (current sinking) connected between output and positive supply.

Nylon

This is the generic name for synthetic fiber forming polyamides.

O

OFHC (Oxygen Free High Conductivity Copper)

Ohm

The electrical unit of resistance. The value of resistance by which a potential difference of one volt will maintain a current of one ampere.

Ohm's Law

$E = I \times R$. Voltage (E) is directly proportional to the product of current (I) and resistance (R) of circuit.

Opto-Coupled

Refers to a technique used to optically activate (turn on) an electronic device usually a transistor or triac, thus physically separating two sides of a circuit, similar to a solenoid relay. The typical opto coupler incorporates an LED (light emitting diode) as the actuating device.

Output

The useful power or signal delivered by a circuit or device.

P

PA (Polyamide, Nylon)

PAL (Phase Alternate Line)

A European color TV system featuring 625 lines per frame, 25 frames and 50 fields per second.

Plastic

High polymeric substances, including both natural and synthetic products, but excluding the rubbers, that are capable of flowing under heat and pressure.

PLTC (Power Limited Tray Cable)

NEC classification for cable resistant to the spread of fire and is suitable for use in cable trays at 300V rating.

Plug

A connector associated with being attached to a cable.

PNP (Sourcing)

Acronym used to describe the polarization of a bipolar junction transistor (BJTs). Also associated with a sourcing output.

PNP Output

A transistor output that switches the positive voltage to the load (current sourcing) connected between output and common.

Polarization

The feature of a connector that prevents mismatching by allowing plugging to occur only when the connectors are properly oriented.

Polyurethane (PUR)

Is a thermoplastic material with good natural chemical resistance.

Polyvinyl Chloride (PVC)

Is a thermoplastic material with good specific properties when blended with additives.

POM (Polyoxymethylene, Acetal, Delrin)

Polyoxymethylene – a crystalline thermoplastic polymer with a high melting point. It is suitable for mechanical parts or electrical insulators that require structural strength at above normal temperatures.

Potting

This is the sealing of a cable termination or other component with a liquid that thermo sets into an elastomer.

PUR (Polyurethane)

Broad class of polymers noted for good abrasion and solvent resistance.

PVC (Polyvinyl Chloride)

A general purpose thermoplastic widely used for wire and cable insulation and jackets.

PVDF (Polyvinylidene Fluoride)

Q

R

Receptacle

The connector is usually mounted in a fixed location and mates with a plug type connector.

Rectification

This is a term used to describe an electrical process, which converts AC (alternating current) to DC (direct current).

Reed Switch

This is a miniature mechanical switch, which changes states when a magnetic field is applied.

Resistance (RI)

The measurement of difficulty in moving electrical current through a medium when voltage is applied. It is measured in ohms.

Resistor

This is an electrical device, which opposes the flow of current. Higher resistor Ohm values offer more resistance to the flow of current.

Retractable Cord (Coiled Cord)

A cord having a specially treated jacket or insulation, so that it will retract like a spring. Retraction may be added to all or part of a cord's length.

RF (Radio Frequency)

RG/U (RG) (Radio Guide)

A military designation for a coaxial cable, and 'U' stands for Universal.

RGB (Red, Green, Blue)

3 parts of color video signal; also refers to multi coaxial cables carrying the above signals.

RJ45

Modular telecommunications connector.

RMS (Root Mean Square)

Rubber

A general term used to describe wire insulation made of thermosetting elastomer, such as natural or synthetic rubbers, neoprene, Hypalon, CPE butyl rubber and others.

S

SAE (Society of Automotive Engineers)

SBR

A copolymer of styrene and butadiene. Most commonly used type of synthetic rubber.

Glossary of Terms

SDI (Serial Digital)

Digital information that is transmitted in serial form.

SDL (Shielded Data Link)

Separator

Pertaining to the wire and cable, a layer of textile, paper, etc. which is placed between the outer jacket and core construction to enhance jacket strip ability.

Serve

A filament or group of filaments such as fibers or wires, wound around a central core.

Shield

A conductive envelope around the primary conductors that provides an electronic barrier to electromagnetic interference.

Signal

Any visible or audible indication that can convey information. Also, the information conveyed through a communication system.

Silicone

This is a rubber like manmade material used extensively in gasket and sealing applications. It is very resistant to a great range of chemicals including oils and solvents, and has a very wide temperature range.

Sinking

The term is used here to describe the way a switch is connected in the circuit. If the switch completes the electrical circuit by connecting the load to ground(/) it is considered to be sinking the load. In a solid-state device this is equivalent to a NPN output.

SJ00

A UL designation for a rubber jacketed junior service cord with oil resistant conductors and jacket. Voltage rating is 300V.

SJ00W

Same as SJ00, but with UL rating for outdoor use.

SNR (Signal to Noise Ratio)

Commonly used interchangeably with ACR

Solid Conductor

A conductor consisting of a single wire.

Solid State

This is a term used often to describe an electronic device, which is made up of solid components (no moving parts).

S00

A UL designation for a rubber insulated hard service cord with oil resistance primaries and jacket. Voltage rating is 600V.

S00W

Same as S00 with UL rating for outdoor use.

S00W-A

UL rating superceded by S00W cable.

Sourcing

The term is used here to describe the way a switch is connected in the circuit. If the switch completes the electrical circuit by connecting the load to the positive (+) it is considered to be sourcing the load.

SPDT (Single Pole Double Throw) - Switches

SRL (Structured Return Loss)

The magnitude of internal cable reflections, measured in dB".

STO

A UL designation for a thermoplastic (usually PVC) insulated hard service cord with oil resistant outer jacket. Voltage rating is 600V.

STOW

Same as STO with UL rating for outdoor use.

STOW-A

Obsolete – replaced by STOW.

STP (Shielded Twisted Pair)

Stranded Conductor

A conductor composed of groups of wires twisted together.

SVHS (Super VHS)

A video format in which the two parts of the VHS signal are transmitted separately providing for better picture resolution with less noise.

SWR (Standing Wave Ration)

A ratio of the maximum amplitude to the minimum amplitude of a standing wave stated in current or voltage amplitudes.

T

Temperature Rating

The maximum temperature at which a material may be used in continuous operation without loss of its basic properties.

TFE (Tetrafluoroethylene)

A thermoplastic material with good electrical insulating

properties and chemical and heat resistance.

Thermoplastic

A material that will soften, flow or distort appreciably when subjected to heat and pressure.

Thermoset

A material that hardens or sets when heat is applied, and which, once set, cannot be softened by heating. The application of heat is called "curing".

TIA (Telecommunications Industry Association)

TPE (Thermoplastic Elastomer)

Used as a jacket material in multiconductor cables, TPE is a thermoplastic compound resistant to the harmful effects of weld slag and chemicals, especially oil.

TP-PMD (Twisted Pair - Physical Medium Dependent)

TPU (Thermo Plastic-Poly Urethane)

Transistor

This is a solid-state device used in electronic circuits. It is often used in switching or amplifier applications.

Triac

This is a solid-state device often used to switch AC voltage/current.

Twisted Pairs

One or more pairs of insulated conductors twisted together to reduce cross talk.

U

UHF (Ultra High Frequency) – 300 to 3,000 MHz"

UL (Underwriter's Laboratories)

A nonprofit organization, which tests and verifies construction and performance of electronic parts.

UP (Universal Power)

UTD (Unshielded Twisted Pair)

V

VA (Volt Ampere)

A designation of power in terms of voltage and current.

VDE (Verband Deutscher Elektrotechniker)

German approval agency equivalent to UL.

Volt (V)

The unit of measure for electrical potential.

Voltage

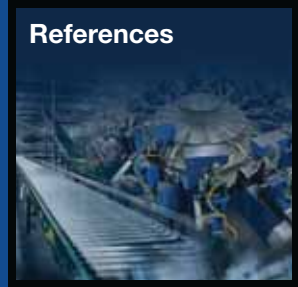

Be Certain with Belden

Glossary of Terms

The term most often used in place of electromotive force, potential difference, or voltage drop. Designates the electrical pressure existing between two points that is capable of producing a current when a closed circuit is connected between these points.

Voltage Rating

The highest voltage that may be continuously applied to a wire in conformance with standards or specifications.

Voltage Spike

This is a short-term (transient) condition causing a larger than normal amount of voltage to be applied to a circuit. Voltage spikes can often cause damage to an electric device if it is not properly protected.

VW-1

A flammability rating established by Underwriters Laboratories for wires and cables that pass a specially designed vertical flame test, formerly designated FR1.

W

W (Watt or Wattage)

A unit of measure for electrical power.

Watt (W)

The unit of measure for electrical power.

Wicking

Capillary absorption of a liquid along the fibers of the base material.

Withdrawal Force

The force required to separate two mated contacts or group of contacts.

X

X

The alpha symbol for Reactance – opposition to alternating electric current flow caused by inductance and capacitance in a circuit.

XLR

A multi pin audio connector (typically 3 pins) used in a microphone, line level and snake cable connections.

Y

Z

Part Number Index

Part Number	Page No.	Part Number	Page No.	Part Number	Page No.
0906 UTP 101	216-217	ASB 2-RKT 4-3-632/2 M	202-203	ASB 2-RKWT 4-3-645/5 M	202-203
0906 UTP 201	226-227	ASB 2-RKT 4-3-632/5 M	202-203	ASB 2-RKWT/LED A 3-224/1 M	194-195
0906 UTP 202	226-227	ASB 2-RKT 4-3-637/0.3 M	202-203	ASB 2-RKWT/LED A 3-224/1.5 M	194-195
0906 UTP 203	228-229	ASB 2-RKT 4-3-637/0.6 M	202-203	ASB 2-RKWT/LED A 3-224/2 M	194-195
0906 UTP 204	228-229	ASB 2-RKT 4-3-637/1 M	202-203	ASB 2-RST 5-228/0.2-RKT 5-228/1 M	196-197
0906 UTP 301	218-219	ASB 2-RKT 4-3-637/1.5 M	202-203	ASB 2-RST 5-228/0.2-RKT 5-228/1.5 M	196-197
0906 UTP 302	220-221	ASB 2-RKT 4-3-637/2 M	202-203	ASB 2-RST 5-228/0.2-RKT 5-228/2 M	196-197
0906 UTP 303	222-223	ASB 2-RKT 4-3-637/5 M	202-203	ASB 2-VAD 1A-1-3-226/1 M	198-199
0906 UTP 312	224-225	ASB 2-RKT 4-3-643/0.3 M	202-203	ASB 2-VAD 1A-1-3-226/1.5 M	198-199
0909 UAC 101	236	ASB 2-RKT 4-3-643/0.6 M	202-203	ASB 2-VAD 1A-1-3-226/2 M	198-199
0936 DFC 351	268-269	ASB 2-RKT 4-3-643/1 M	202-203	ASB 2-VB 1A-1-1-226/1 M	200-201
0936 DMC 351	268-269	ASB 2-RKT 4-3-643/1.5 M	202-203	ASB 2-VB 1A-1-1-226/1.5 M	200-201
0976 EFC 152	248-249	ASB 2-RKT 4-3-643/2 M	202-203	ASB 2-VB 1A-1-1-226/2 M	200-201
0976 EMC 102	322-323	ASB 2-RKT 4-3-643/5 M	202-203	ASB 2-VBD 1A-1-1-226/1 M	198-199
0976 PFC 101	320-321	ASB 2-RKT 4-3-645/0.3 M	202-203	ASB 2-VBD 1A-1-1-226/1.5 M	198-199
0976 PFC 102	322-323	ASB 2-RKT 4-3-645/0.6 M	202-203	ASB 2-VBD 1A-1-1-226/2 M	198-199
0976 PMC 101	320-321	ASB 2-RKT 4-3-645/1 M	202-203	ASB 2-VC 1A-1-3-226/1 M	200-201
0976 PMC 102	322-323	ASB 2-RKT 4-3-645/1.5 M	202-203	ASB 2-VC 1A-1-3-226/1.5 M	200-201
AKB 2-RST 3-602/0.3 M	204-205	ASB 2-RKT 4-3-645/2 M	202-203	ASB 2-VC 1A-1-3-226/2 M	200-201
AKB 2-RST 3-602/0.6 M	204-205	ASB 2-RKT 4-3-645/5 M	202-203	ASB 4 5-4-328/5 M	26-27
AKB 2-RST 3-602/1 M	204-205	ASB 2-RKWT 4-3-224/1 M	192-193	ASB 4 5-4-328/10 M	26-27
AKB 2-RST 3-602/1.5 M	204-205	ASB 2-RKWT 4-3-224/1.5 M	192-193	ASB 4/LED 5-4-328/5 M	28-29
AKB 2-RST 3-602/2 M	204-205	ASB 2-RKWT 4-3-224/2 M	192-193	ASB 4/LED 5-4-328/10 M	28-29
AKB 2-RST 3-602/5 M	204-205	ASB 2-RKWT 4-3-251/1 M	192-193	ASB 4/LED 5-4-328/RS120M	30-31
ASB 2 4-3-632/0.3 M	202-203	ASB 2-RKWT 4-3-251/1.5 M	192-193	ASB 6 5-4-330/5 M	26-27
ASB 2 4-3-632/0.6 M	202-203	ASB 2-RKWT 4-3-251/2 M	192-193	ASB 6 5-4-330/10 M	26-27
ASB 2 4-3-632/1 M	202-203	ASB 2-RKWT 4-3-632/0.3 M	202-203	ASB 8 5-4-331/5 M	26-27
ASB 2 4-3-632/1.5 M	202-203	ASB 2-RKWT 4-3-632/0.6 M	202-203	ASB 8 5-4-331/10 M	26-27
ASB 2 4-3-632/2 M	202-203	ASB 2-RKWT 4-3-632/1 M	202-203	ASB 6/LED 5-4-330/5 M	28-29
ASB 2 4-3-632/5 M	202-203	ASB 2-RKWT 4-3-632/1.5 M	202-203	ASB 6/LED 5-4-330/10 M	28-29
ASB 2-RKMWW/LED A 3-224/1 M	194-195	ASB 2-RKWT 4-3-632/2 M	202-203	ASB 8/LED 5-4/1.5M	32-33
ASB 2-RKMWW/LED A 3-224/1.5 M	194-195	ASB 2-RKWT 4-3-632/5 M	202-203	ASB 8/LED 5-4-331/5 M	28-29
ASB 2-RKMWW/LED A 3-224/2 M	194-195	ASB 2-RKWT 4-3-637/0.3 M	202-203	ASB 8/LED 5-4-331/10 M	28-29
ASB 2-RKT 4-3-224/1 M	192-193	ASB 2-RKWT 4-3-637/0.6 M	202-203	ASB 8/LED 5-4-331/RS120M	30-31
ASB 2-RKT 4-3-224/1.5 M	192-193	ASB 2-RKWT 4-3-637/1 M	202-203	ASBA 2-RKT 4-3-224/1 M	192-193
ASB 2-RKT 4-3-224/2 M	192-193	ASB 2-RKWT 4-3-637/1.5 M	202-203	ASBA 2-RKT 4-3-224/1.5 M	192-193
ASB 2-RKT 4-3-251/1 M	192-193	ASB 2-RKWT 4-3-637/2 M	202-203	ASBA 2-RKT 4-3-224/2 M	192-193
ASB 2-RKT 4-3-251/1.5 M	192-193	ASB 2-RKWT 4-3-637/5 M	202-203	ASBM 4/LED 3-343/5 M	16-17
ASB 2-RKT 4-3-251/2 M	192-193	ASB 2-RKWT 4-3-645/0.3 M	202-203	ASBM 4/LED 3-343/10 M	16-17
ASB 2-RKT 4-3-632/0.3 M	202-203	ASB 2-RKWT 4-3-645/0.6 M	202-203	ASBM 4/LED 3-343/15 M	16-17
ASB 2-RKT 4-3-632/0.6 M	202-203	ASB 2-RKWT 4-3-645/1 M	202-203	ASBM 6/LED 3-344/5 M	16-17
ASB 2-RKT 4-3-632/1 M	202-203	ASB 2-RKWT 4-3-645/1.5 M	202-203	ASBM 6/LED 3-344/10 M	16-17
ASB 2-RKT 4-3-632/1.5 M	202-203	ASB 2-RKWT 4-3-645/2 M	202-203	ASBM 6/LED 3-344/15 M	16-17

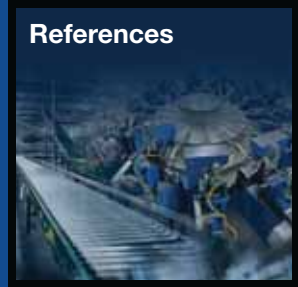

Be Certain with Belden

Part Number Index

Part Number	Page No.	Part Number	Page No.	Part Number	Page No.
ASBM 8/LED 3-345/5 M	16-17	ASBV 6 5-332/5 M	34-35	PRKWT/LED P 4-07/5 M	94-95
ASBM 8/LED 3-345/10 M	16-17	ASBV 6 5-332/10 M	34-35	PRKWT/LED P 4-07/10 M	94-95
ASBM 8/LED 3-345/15 M	16-17	ASBV 6/LED 5-332/5 M	36-37	PRKWT/LED P 4-07/25 M	94-95
ASBM 10/LED 3-346/5 M	16-17	ASBV 6/LED 5-332/10 M	36-37	PRSFM 4	250-251
ASBM 10/LED 3-346/10 M	16-17	ASBV 6/LED 5-332/15 M	36-37	PRSFM 4/0.5 M	266-267
ASBM 10/LED 3-346/15 M	16-17	ASBV 8 4-3-139/RS190M	38-39	PRSFM 5	250-251
ASBM 12/LED 3-347/5 M	16-17	ASBV 8 5-242/5 M	34-35	PRSFM 5/0.5 M	266-267
ASBM 12/LED 3-347/10 M	16-17	ASBV 8 5-242/10 M	34-35	PRSFM 8/0.5 M	266-267
ASBM 12/LED 3-347/15 M	16-17	ASBV 8/LED 5-242/5 M	36-37	PRST 4-07/10 M	90-91
ASBS 2 M12-4S-90	212-213	ASBV 8/LED 5-242/10 M	36-37	PRST 4-07/25 M	90-91
ASBS 2 M12-5	208-209	ASBV 8/LED 5-242/15 M	36-37	PRST 4-07/5 M	90-91
ASBS 2 M12-5 1-1	208-209	ASBV 8/LED 5-242/RS190M	40-41	PRST 4-PRKT 4-07/2 M	158-159
ASBS 2 M12-5-90	212-213	ASNBL 8/LED 5-4-320/5 M	24-25	PRST 4-PRKT 4-07/5 M	158-159
ASBS 2 M12-5S	208-209	ASNBL 8/LED 5-4-320/10 M	24-25	PRST 4-PRKWT/LED P 4-07/2 M	160-161
ASBS 2 M12-S2325	212-213	ASNBL 8/LED 5-4-320/15 M	24-25	PRST 4-PRKWT/LED P 4-07/5 M	160-161
ASBS 2 M12-S2326	210-211	ASNBV 8/LED 5-278/5 M	22-23	PZVK	236
ASBS 2 M8	208-209	ASNBV 8/LED 5-278/10 M	22-23	RK 20-603/2 M	114-115
ASBS 2 M8-90	212-213	ASNBV 8/LED 5-278/15 M	22-23	RK 20-603/5 M	114-115
ASBS 4/LED 5-4	44-45	AWKZ	239	RK 20-603/10 M	114-115
ASBS 6 5-4	42-43	AWKZ 12/19	239	RK 20-678/6 F	106-107
ASBS 6/LED 5-4	44-45	AWKZ 3/4	239	RK 20-678/12 F	106-107
ASBS 8 5-4	42-43	DMWKZ	238	RK 20-678/15 F	106-107
ASBS 8/LED 5-4	44-45	DMWKZ 8	238	RK 20-678/20 F	106-107
ASBS 8/LED 5-4/4E4A	46-47	DMWKZ K 12	238	RK 20-678/30 F	106-107
ASBSA 2 M12-3	208-209	DMWKZ K 8	238	RK 30-601/2 M	118-119
ASBSM 4/LED 3	14-15	FASBS 2 M12-5S	214-215	RK 30-601/5 M	118-119
ASBSM 6/LED 3	14-15	FWD 5	252-253	RK 30-601/10 M	118-119
ASBSM 8/LED 3	14-15	FWD 5B	252-253	RK 30-619/6 F	106-107
ASBSM 10/LED 3	14-15	PRKFM 4/0.5 M	266-267	RK 30-619/12 F	106-107
ASBSV 4 5-4	48-49	PRKFM 5/0.5 M	266-267	RK 30-619/15 F	106-107
ASBSV 6 5-4	48-49	PRKFM 8/0.5 M	266-267	RK 30-619/20 F	106-107
ASBSV 8 5-4	48-49	PRKT 4-07/5 M	92-93	RK 30-619/30 F	106-107
ASBSV 4/LED 5-4	50-51	PRKT 4-07/10 M	92-93	RK 30-645/2 M	114-115
ASBSV 6/LED 5-4	50-51	PRKT 4-07/25 M	92-93	RK 30-645/5 M	114-115
ASBSV 8/LED 5-4	50-51	PRKT 5-56/5 M	92-93	RK 30-645/10 M	114-115
ASBSVD 8/LED W5	52-53	PRKT 5-56/10 M	92-93	RK 30-731/6 F	114-115
ASBV 4 4-3-138/RS120M	38-39	PRKT 5-56/25 M	92-93	RK 30-731/12 F	114-115
ASBV 4 5-256/5 M	34-35	PRKWT 4-07/5 M	92-93	RK 30-731/15 F	114-115
ASBV 4 5-256/10 M	34-35	PRKWT 4-07/10 M	92-93	RK 30-731/20 F	114-115
ASBV 4/LED 5-256/5 M	36-37	PRKWT 4-07/25 M	92-93	RK 30-731/30 F	114-115
ASBV 4/LED 5-256/10 M	36-37	PRKWT 5-56/5 M	92-93	RK 30-741/6 F	110-111
ASBV 4/LED 5-256/15 M	36-37	PRKWT 5-56/10 M	92-93	RK 30-741/12 F	110-111
ASBV 4/LED 5-256/RS120M	40-41	PRKWT 5-56/25 M	92-93	RK 30-741/15 F	110-111

Part Number Index

Part Number	Page No.	Part Number	Page No.	Part Number	Page No.
RK 30-741/20 F	110-111	RK 60A-697/20 F	106-107	RK 120M-654/12 F	126-127
RK 30-741/30 F	110-111	RK 60A-697/30 F	106-107	RK 120M-654/15 F	126-127
RK 30-738/6 F	106-107	RK 60B-696/6 F	122-123	RK 120M-654/20 F	126-127
RK 30-738/12 F	106-107	RK 60B-696/12 F	122-123	RK 120M-654/30 F	126-127
RK 30-738/15 F	106-107	RK 60B-696/15 F	122-123	RK 100M-699/6 F	128-129
RK 30-738/20 F	106-107	RK 60B-696/20 F	122-123	RK 100M-699/12 F	128-129
RK 30-738/30 F	106-107	RK 60B-696/30 F	122-123	RK 100M-699/15 F	128-129
RK 40-602/2 M	114-115	RK 70M-622/6 F	122-123	RK 100M-699/20 F	128-129
RK 40-602/5 M	114-115	RK 70M-622/12 F	122-123	RK 100M-699/30 F	128-129
RK 40-602/10 M	114-115	RK 70M-622/15 F	122-123	RK 120M-724/6 F	128-129
RK 40-637/6 F	114-115	RK 70M-622/20 F	122-123	RK 120M-724/12 F	128-129
RK 40-637/12 F	114-115	RK 70M-622/30 F	122-123	RK 120M-724/15 F	128-129
RK 40-637/15 F	114-115	RK 70M-649/6 F	124-125	RK 120M-724/20 F	128-129
RK 40-637/20 F	114-115	RK 70M-649/12 F	124-125	RK 120M-724/30 F	128-129
RK 40-637/30 F	114-115	RK 70M-649/15 F	124-125	RK 120M-728/6 F	130-131
RK 40-739/6 F	106-107	RK 70M-649/20 F	124-125	RK 120M-728/12 F	130-131
RK 40-739/12 F	106-107	RK 70M-649/30 F	124-125	RK 120M-728/15 F	130-131
RK 40-739/15 F	106-107	RK 80M-650/6 F	124-125	RK 120M-728/20 F	130-131
RK 40-739/20 F	106-107	RK 80M-650/12 F	124-125	RK 120M-728/30 F	130-131
RK 40-739/30 F	106-107	RK 80M-650/15 F	124-125	RK 120M-676/2 M	132-133
RK 50-742/6 F	110-111	RK 80M-650/20 F	124-125	RK 120M-676/5 M	132-133
RK 50-742/12 F	110-111	RK 80M-650/30 F	124-125	RK 120M-676/10 M	132-133
RK 50-742/15 F	110-111	RK 80M-698/6 F	122-123	RK 120M-676/15 M	132-133
RK 50-742/20 F	110-111	RK 80M-698/12 F	122-123	RK 190M-669/2 M	132-133
RK 50-742/30 F	110-111	RK 80M-698/15 F	122-123	RK 190M-669/5 M	132-133
RK 50-755/6 F	110-111	RK 80M-698/20 F	122-123	RK 190M-669/10 M	132-133
RK 50-755/12 F	110-111	RK 80M-698/30 F	122-123	RK 190M-669/15 M	132-133
RK 50-755/15 F	110-111	RK 90M-623/6 F	128-129	RKC 30/11	328-329
RK 50-755/20 F	110-111	RK 90M-623/12 F	128-129	RKC 30/9	328-329
RK 50-755/30 F	110-111	RK 90M-623/15 F	128-129	RKC 3U/7	324-325
RK 50-777/6 F	106-107	RK 90M-623/20 F	128-129	RKC 3U/9	324-325
RK 50-777/12 F	106-107	RK 90M-623/30 F	128-129	RKC 4/3/7	304-305
RK 50-777/15 F	106-107	RK 90M-651/6 F	126-127	RKC 4/3/9	304-305
RK 50-777/20 F	106-107	RK 90M-651/12 F	126-127	RKC 4/7	304-305
RK 50-777/30 F	106-107	RK 90M-651/15 F	126-127	RKC 4/9	304-305
RK 50-794/6 F	114-115	RK 90M-651/20 F	126-127	RKC 4/DUO	316-317
RK 50-794/12 F	114-115	RK 90M-651/30 F	126-127	RKC 5/DUO	316-317
RK 50-794/15 F	114-115	RK 100M-652/6 F	126-127	RKC 40/9	328-329
RK 50-794/20 F	114-115	RK 100M-652/12 F	126-127	RKC 5/7	304-305
RK 50-794/30 F	114-115	RK 100M-652/15 F	126-127	RKC 5/9	304-305
RK 60A-697/6 F	106-107	RK 100M-652/20 F	126-127	RKC 50/11	328-329
RK 60A-697/12 F	106-107	RK 100M-652/30 F	126-127	RKC 50/16	328-329
RK 60A-697/15 F	106-107	RK 120M-654/6 F	126-127	RKC 50/9	328-329

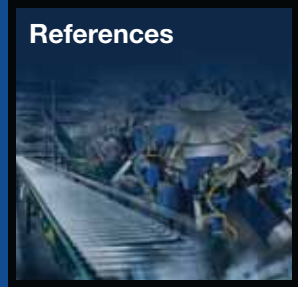

Be Certain with Belden

Part Number Index

Part Number	Page No.	Part Number	Page No.	Part Number	Page No.
RKC 8/9	304-305	RKF 30/11-05	280-281	RKF 190M-669/1F	296-297
RKC 120/13.5	334-335	RKF 30/13.5-01	280-281	RKFM 4/0.5 M	260-261
RKC 190/13.5	334-335	RKF 30/13.5-05	280-281	RKFM 4-3/0.5 M	260-261
RKC/LED 4/7	308-309	RKF 30-601/0.3 M	288-289	RKFM 5/0.5 M	260-261
RKC/LED 4/9	308-309	RKF 30-695/0.3 M	286-287	RKFM 5/20/0.5 M	262-263
RKCN 4/7	312-313	RKF 301-638/1F	282-283	RKFM 8/0.5 M	260-261
RKCN 4/9	312-313	RKF 301-641/1F	284-285	RKFPM 4/0,5 M	264-265
RKCN 4/DUO	318-319	RKF 4 U/1F	276-277	RKFPM 4-3/0,5 M	264-265
RKCN 5/7	312-313	RKF 4/0.5M	254-255	RKFPM 5/0,5 M	264-265
RKCN 5/9	312-313	RKF 4-1/2-14/0.5 M	258-259	RKFPM 8/0,5 M	264-265
RKCN 8/9	312-313	RKF 4-3/0.5M	254-255	RKHL 4/S 5.5	248-249
RKCQ 4/3/7	310-311	RKF 4-3-1/2-14/0.5 M	258-259	RKHL 5/S 5.5	248-249
RKCQ 4/3/9	310-311	RKF 4-3-S3103/0.5 M	256-257	RKHL 8/S 5,5	248-249
RKCQ 4/7	310-311	RKF 4-S3103/0.5 M	256-257	RKM 3-06/2 M	68-69
RKCQ 4/9	310-311	RKF 40/11-02	280-281	RKM 3-06/5 M	68-69
RKCQS 4/3/9	322-323	RKF 40/13.5-02	280-281	RKM 3-06/10 M	68-69
RKCQS 4/9	322-323	RKF 40-693/0.3 M	286-287	RKM 3-224/2 M	68-69
RKCS 4/9	320-321	RKF 401-639/1F	282-283	RKM 3-224/5 M	68-69
RKCS 5/9	320-321	RKF 5 TB	270-271	RKM 3-224/10 M	68-69
RKCS 8/9	320-321	RKF 5 U/1F	276-277	RKM 4-07/2 M	68-69
RKCW 120/13.5	334-335	RKF 5/0.5M	254-255	RKM 4-07/5 M	68-69
RKCW 190/13.5	334-335	RKF 5-1/2-14/0.5 M	258-259	RKM 4-07/10 M	68-69
RKCW 3U/7	326-327	RKF 5-S3103/0.5 M	256-257	RKM 4-225/2 M	68-69
RKCW 3U/9	326-327	RKF 50/11-04	280-281	RKM 4-225/5 M	68-69
RKCW 4/3/7	306-307	RKF 50/13.5-04	280-281	RKM 4-225/10 M	68-69
RKCW 4/3/9	306-307	RKF 50-694/0.3 M	286-287	RKMC 3	298-299
RKCW 4/7	306-307	RKF 501-642/1F	284-285	RKMC 4	298-299
RKCW 4/9	306-307	RKF 501-677/1F	282-283	RKMCK 3	302-303
RKCW 5/7	306-307	RKF 501-690/1F	284-285	RKMCK 4	302-303
RKCW 5/9	306-307	RKF 601A-697/1F	282-283	RKMCW 3	300-301
RKCW 8/9	306-307	RKF 601B-696/1F	290-291	RKMCW 4	300-301
RKCW/LED 4/7	308-309	RKF 701M-622/1F	290-291	RKMF 3/0,5 M	238-239
RKCW/LED 4/9	308-309	RKF 8/0.5M	254-255	RKMF 4/0,5 M	238-239
RKCWN 4/7	314-315	RKF 8-1/2-14/0.5M	258-259	RKMHL 3/S 5,5	236-237
RKCWN 4/9	314-315	RKF 8-S3103/0.5 M	256-257	RKMHL 4/S 5,5	236-237
RKCWN 5/7	314-315	RKF 801M-698/1F	290-291	RKMV 3-06/2 M	64-65
RKCWN 5/9	314-315	RKF 901M-623/1F	292-293	RKMV 3-06/5 M	64-65
RKF 20/11-03	280-281	RKF 1001M-699/1F	292-293	RKMV 3-06/10 M	64-65
RKF 20/13.5-03	280-281	RKF 1201M-624/1F	292-293	RKMV 3-224/2 M	64-65
RKF 201-678/1F	282-283	RKF 1201M-630/0.3M	294-295	RKMV 3-224/5 M	64-65
RKF 20-603/0.3 M	286-287	RKF 1201M-676/1F	296-297	RKMV 3-224/10 M	64-65
RKF 3 U/1F	276-277	RKF 120M-676/1F	296-297	RKMV 4-07/2 M	64-65
RKF 30/11-01	280-281	RKF 1901M-669/1F	296-297	RKMV 4-07/5 M	64-65

Part Number Index

Part Number	Page No.	Part Number	Page No.	Part Number	Page No.
RKMV 4-07/10 M	64-65	RKMWV/LED A 3-224/5 M	66-67	RKT 4-3-632/5 M	80-81
RKMV 4-225/2 M	64-65	RKMWV/LED A 3-224/10 M	66-67	RKT 4-3-632/10 M	80-81
RKMV 4-225/5 M	64-65	RKMWVS 3-357/5 M	72-73	RKT 4-3-645/2 M	80-81
RKMV 4-225/10 M	64-65	RKMWVS 4-358/5 M	72-73	RKT 4-3-645/5 M	80-81
RKMV 8-354/2 M	64-65	RKT 3U-226/5 M	96-97	RKT 4-3-645/10 M	80-81
RKMV 8-354/5 M	64-65	RKT 3U-618/6 F	98-99	RKT 4-3-731/2 M	80-81
RKMV 8-354/10 M	64-65	RKT 3U-618/12 F	98-99	RKT 4-3-731/5 M	80-81
RKMVS 3-357/5 M	72-73	RKT 3U-618/15 F	98-99	RKT 4-3-731/10 M	80-81
RKMVS 4-358/5 M	72-73	RKT 3U-618/20 F	98-99	RKT 4-602/2 M	80-81
RKMW 3-06/2 M	68-69	RKT 3U-619/6 F	102-103	RKT 4-602/5 M	80-81
RKMW 3-06/5 M	68-69	RKT 3U-619/12 F	102-103	RKT 4-602/10 M	80-81
RKMW 3-06/10 M	68-69	RKT 3U-61915 F	102-103	RKT 4-633/2 M	80-81
RKMW 3-224/2 M	68-69	RKT 3U-619/20 F	102-103	RKT 4-633/5 M	80-81
RKMW 3-224/5 M	68-69	RKT 3U-664/6 F	98-99	RKT 4-633/10 M	80-81
RKMW 3-224/10 M	68-69	RKT 3U-664/12 F	98-99	RKT 4-637/2 M	80-81
RKMW 4-07/2 M	68-69	RKT 3U-664/15 F	98-99	RKT 4-637/5 M	80-81
RKMW 4-07/5 M	68-69	RKT 3U-664/20 F	98-99	RKT 4-637/10 M	80-81
RKMW 4-07/10 M	68-69	RKT 3U-688/6 F	98-99	RKT 4-643/2 M	80-81
RKMW 4-225/2 M	68-69	RKT 3U-688/12 F	98-99	RKT 4-643/5 M	80-81
RKMW 4-225/5 M	68-69	RKT 3U-688/15 F	98-99	RKT 4-643/10 M	80-81
RKMW 4-225/10 M	68-69	RKT 3U-688/20 F	98-99	RKT 4-679/2 M	80-81
RKMW/LED A 3-06/2 M	70-71	RKT 4-07/2 M	78-79	RKT 4-679/5 M	80-81
RKMW/LED A 3-06/5 M	70-71	RKT 4-07/5 M	78-79	RKT 4-679/10 M	80-81
RKMW/LED A 3-06/10 M	70-71	RKT 4-07/10 M	78-79	RKT 4U-674/6 F	98-99
RKMW/LED A 3-224/2 M	70-71	RKT 4-225/2 M	78-79	RKT 4U-674/12 F	98-99
RKMW/LED A 3-224/5 M	70-71	RKT 4-225/5 M	78-79	RKT 4U-674/15 F	98-99
RKMW/LED A 3-224/10 M	70-71	RKT 4-225/10 M	78-79	RKT 4U-674/20 F	98-99
RKMWV 3-06/2 M	64-65	RKT 4-251/2 M	78-79	RKT 4U-689/6 F	98-99
RKMWV 3-06/5 M	64-65	RKT 4-251/5 M	78-79	RKT 4U-689/12 F	98-99
RKMWV 3-06/10 M	64-65	RKT 4-251/10 M	78-79	RKT 4U-689/15 F	98-99
RKMWV 3-224/2 M	64-65	RKT 4-3-06/2 M	78-79	RKT 4U-689/20 F	98-99
RKMWV 3-224/5 M	64-65	RKT 4-3-06/5 M	78-79	RKT 5-56/2 M	78-79
RKMWV 3-224/10 M	64-65	RKT 4-3-06/10 M	78-79	RKT 5-56/5 M	78-79
RKMWV 4-07/2 M	64-65	RKT 4-3-224/2 M	78-79	RKT 5-56/10 M	78-79
RKMWV 4-07/5 M	64-65	RKT 4-3-224/5 M	78-79	RKT 5-228/2 M	78-79
RKMWV 4-07/10 M	64-65	RKT 4-3-224/10 M	78-79	RKT 5-228/5 M	78-79
RKMWV 4-225/2 M	64-65	RKT 4-3-260/2 M	78-79	RKT 5-228/10 M	78-79
RKMWV 4-225/5 M	64-65	RKT 4-3-260/5 M	78-79	RKT 5-259/2 M	78-79
RKMWV 4-225/10 M	64-65	RKT 4-3-260/10 M	78-79	RKT 5-259/5 M	78-79
RKMWV/LED A 3-06/2 M	66-67	RKT 4-3-610/2 M	80-81	RKT 5-259/10 M	78-79
RKMWV/LED A 3-06/5 M	66-67	RKT 4-3-610/5 M	80-81	RKT 5-612/2 M	80-81
RKMWV/LED A 3-06/10 M	66-67	RKT 4-3-610/10 M	80-81	RKT 5-612/5 M	80-81
RKMWV/LED A 3-224/2 M	66-67	RKT 4-3-632/2 M	80-81	RKT 5-612/10 M	80-81

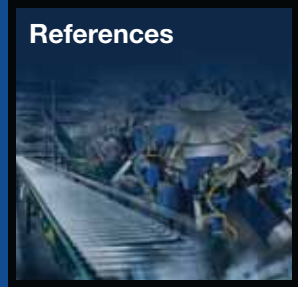

Be Certain with Belden

Part Number Index

Part Number	Page No.	Part Number	Page No.	Part Number	Page No.
RKT 5-644/2 M	80-81	RKT/LED C 4-3-610/1 M	84-85	RKUE 19-242/10 M	134-135
RKT 5-644/5 M	80-81	RKT/LED C 4-3-610/2 M	84-85	RKUE 19-242/15 M	134-135
RKT 5-644/10 M	80-81	RKT/LED C 4-3-610/5 M	84-85	RKUE 19-242/20 M	134-135
RKT 5U-673/6 F	98-99	RKT/LED C 4-3-610/10 M	84-85	RKV	236
RKT 5U-673/12 F	98-99	RKT/LED C 4-3-632/1 M	84-85	RKV M23	236
RKT 5U-673/15 F	98-99	RKT/LED C 4-3-632/2 M	84-85	RKW 20-603/2 M	116-117
RKT 5U-673/20 F	98-99	RKT/LED C 4-3-632/5 M	84-85	RKW 20-603/5 M	116-117
RKT 5U-755/6 F	98-99	RKT/LED C 4-3-632/10 M	84-85	RKW 20-603/10 M	116-117
RKT 5U-755/12 F	98-99	RKT/LED F 4-633/1 M	84-85	RKW 20-678/6 F	108-109
RKT 5U-755/15 F	98-99	RKT/LED F 4-633/2 M	84-85	RKW 20-678/12 F	108-109
RKT 5U-755/20 F	98-99	RKT/LED F 4-633/5 M	84-85	RKW 20-678/15 F	108-109
RKT 8-282/2 M	78-79	RKT/LED F 4-633/10 M	84-85	RKW 20-678/20 F	108-109
RKT 8-282/5 M	78-79	RKT/LED F 4-679/1 M	84-85	RKW 20-678/30 F	108-109
RKT 8-282/10 M	78-79	RKT/LED F 4-679/2 M	84-85	RKW 30-601/2 M	120-121
RKT 8-6-268/2 M	78-79	RKT/LED F 4-679/5 M	84-85	RKW 30-601/5 M	120-121
RKT 8-6-268/5 M	78-79	RKT/LED F 4-679/10 M	84-85	RKW 30-601/10 M	120-121
RKT 8-6-268/10 M	78-79	RKTS 4-182/2 M	88-89	RKW 30-619/6 F	108-109
RKT 8-6-337/2 M	78-79	RKTS 4-182/5 M	88-89	RKW 30-619/12 F	108-109
RKT 8-6-337/5 M	78-79	RKTS 4-182/10 M	88-89	RKW 30-619/15 F	108-109
RKT 8-6-337/10 M	78-79	RKTS 4-288/2 M	88-89	RKW 30-619/20 F	108-109
RKT 8-627/2 M	80-81	RKTS 4-288/5 M	88-89	RKW 30-619/30 F	108-109
RKT 8-627/5 M	80-81	RKTS 4-288/10 M	88-89	RKW 30-645/2 M	116-117
RKT 8-627/10 M	80-81	RKTS 5-183/2 M	88-89	RKW 30-645/5 M	116-117
RKT 12-348/2 M	78-79	RKTS 5-183/5 M	88-89	RKW 30-645/10 M	116-117
RKT 12-348/5 M	78-79	RKTS 5-183/10 M	88-89	RKW 30-731/6 F	116-117
RKT 12-348/10 M	78-79	RKTS 5-298/2 M	88-89	RKW 30-731/12 F	116-117
RKT/LED A 4-3-06/2 M	82-83	RKTS 5-298/5 M	88-89	RKW 30-731/15 F	116-117
RKT/LED A 4-3-06/5 M	82-83	RKTS 5-298/10 M	88-89	RKW 30-731/20 F	116-117
RKT/LED A 4-3-06/10 M	82-83	RKTS 8-184/2 M	88-89	RKW 30-731/30 F	116-117
RKT/LED A 4-3-224/2 M	82-83	RKTS 8-184/5 M	88-89	RKW 30-738/6 F	108-109
RKT/LED A 4-3-224/5 M	82-83	RKTS 8-184/10 M	88-89	RKW 30-738/12 F	108-109
RKT/LED A 4-3-224/10 M	82-83	RKTS 8-299/2 M	88-89	RKW 30-738/15 F	108-109
RKT/LED A 4-3-260/2 M	82-83	RKTS 8-299/5 M	88-89	RKW 30-738/20 F	108-109
RKT/LED A 4-3-260/5 M	82-83	RKTS 8-299/10 M	88-89	RKW 30-738/30 F	108-109
RKT/LED A 4-3-260/10 M	82-83	RKU 12-256/5 M	134-135	RKW 30-741/6 F	112-113
RKT/LED A 4-3-610/1 M	84-85	RKU 12-256/10 M	134-135	RKW 30-741/12 F	112-113
RKT/LED A 4-3-610/2 M	84-85	RKU 12-256/15 M	134-135	RKW 30-741/15 F	112-113
RKT/LED A 4-3-610/5 M	84-85	RKU 12-256/20 M	134-135	RKW 30-741/20 F	112-113
RKT/LED A 4-3-610/10 M	84-85	RKU 19-242/5 M	134-135	RKW 30-741/30 F	112-113
RKT/LED A 4-3-632/1 M	84-85	RKU 19-242/10 M	134-135	RKW 40-602/2 M	116-117
RKT/LED A 4-3-632/2 M	84-85	RKU 19-242/15 M	134-135	RKW 40-602/5 M	116-117
RKT/LED A 4-3-632/5 M	84-85	RKU 19-242/20 M	134-135	RKW 40-602/10 M	116-117
RKT/LED A 4-3-632/10 M	84-85	RKUE 19-242/5 M	134-135	RKW 40-637/6 F	116-117

Part Number Index

Part Number	Page No.	Part Number	Page No.	Part Number	Page No.
RKW 40-637/12 F	116-117	RKWT 3U-664/12 F	100-101	RKWT 4-637/2 M	80-81
RKW 40-637/15 F	116-117	RKWT 3U-664/15 F	100-101	RKWT 4-637/5 M	80-81
RKW 40-637/20 F	116-117	RKWT 3U-664/20 F	100-101	RKWT 4-637/10 M	80-81
RKW 40-637/30 F	116-117	RKWT 3U-688/6 F	100-101	RKWT 4-643/2 M	80-81
RKW 40-739/6 F	108-109	RKWT 3U-688/12 F	100-101	RKWT 4-643/5 M	80-81
RKW 40-739/12 F	108-109	RKWT 3U-688/15 F	100-101	RKWT 4-643/10 M	80-81
RKW 40-739/15 F	108-109	RKWT 3U-688/20 F	100-101	RKWT 4-679/2 M	80-81
RKW 40-739/20 F	108-109	RKWT 4-3-06/2 M	78-79	RKWT 4-679/5 M	80-81
RKW 40-739/30 F	108-109	RKWT 4-3-06/5 M	78-79	RKWT 4-679/10 M	80-81
RKW 50-742/6 F	112-113	RKWT 4-3-06/10 M	78-79	RKWT 4U-689/6 F	100-101
RKW 50-742/12 F	112-113	RKWT 4-3-224/2 M	78-79	RKWT 4U-689/12 F	100-101
RKW 50-742/15 F	112-113	RKWT 4-3-224/5 M	78-79	RKWT 4U-689/15 F	100-101
RKW 50-742/20 F	112-113	RKWT 4-3-224/10 M	78-79	RKWT 4U-689/20 F	100-101
RKW 50-742/30 F	112-113	RKWT 4-3-260/2 M	78-79	RKWT 4U-674/6 F	100-101
RKW 50-755/6 F	112-113	RKWT 4-3-260/5 M	78-79	RKWT 4U-674/12 F	100-101
RKW 50-755/12 F	112-113	RKWT 4-3-260/10 M	78-79	RKWT 4U-674/15 F	100-101
RKW 50-755/15 F	112-113	RKWT 4-3-610/2 M	80-81	RKWT 4U-674/20 F	100-101
RKW 50-755/20 F	112-113	RKWT 4-3-610/5 M	80-81	RKWT 5-56/2 M	78-79
RKW 50-755/30 F	112-113	RKWT 4-3-610/10 M	80-81	RKWT 5-56/5 M	78-79
RKW 50-794/6 F	116-117	RKWT 4-3-632/2 M	80-81	RKWT 5-56/10 M	78-79
RKW 50-794/12 F	116-117	RKWT 4-3-632/5 M	80-81	RKWT 5-228/2 M	78-79
RKW 50-794/15 F	116-117	RKWT 4-3-632/10 M	80-81	RKWT 5-228/5 M	78-79
RKW 50-794/20 F	116-117	RKWT 4-3-645/2 M	80-81	RKWT 5-228/10 M	78-79
RKW 50-794/30 F	116-117	RKWT 4-3-645/5 M	80-81	RKWT 5-259/2 M	78-79
RKW 50-777/6 F	108-109	RKWT 4-3-645/10 M	80-81	RKWT 5-259/5 M	78-79
RKW 50-777/12 F	108-109	RKWT 4-3-731/2 M	80-81	RKWT 5-259/10 M	78-79
RKW 50-777/15 F	108-109	RKWT 4-3-731/5 M	80-81	RKWT 5-612/2 M	80-81
RKW 50-777/20 F	108-109	RKWT 4-3-731/10 M	80-81	RKWT 5-612/5 M	80-81
RKW 50-777/30 F	108-109	RKWT 4-07/2 M	78-79	RKWT 5-612/10 M	80-81
RKW 60A-697/6 F	108-109	RKWT 4-07/5 M	78-79	RKWT 5-644/2 M	80-81
RKW 60A-697/12 F	108-109	RKWT 4-07/10 M	78-79	RKWT 5-644/5 M	80-81
RKW 60A-697/15 F	108-109	RKWT 4-225/2 M	78-79	RKWT 5-644/10 M	80-81
RKW 60A-697/20 F	108-109	RKWT 4-225/5 M	78-79	RKWT 5U-673/6 F	100-101
RKW 60A-697/30 F	108-109	RKWT 4-225/10 M	78-79	RKWT 5U-673/12 F	100-101
RKWT 3U-618/6 F	100-101	RKWT 4-251/2 M	78-79	RKWT 5U-673/15 F	100-101
RKWT 3U-618/12 F	100-101	RKWT 4-251/5 M	78-79	RKWT 5U-673/20 F	100-101
RKWT 3U-618/15 F	100-101	RKWT 4-251/10 M	78-79	RKWT 5U-755/6 F	100-101
RKWT 3U-618/20 F	100-101	RKWT 4-602/2 M	80-81	RKWT 5U-755/12 F	100-101
RKWT 3U-619/6 F	104-105	RKWT 4-602/5 M	80-81	RKWT 5U-755/15 F	100-101
RKWT 3U-619/12 F	104-105	RKWT 4-602/10 M	80-81	RKWT 5U-755/20 F	100-101
RKWT 3U-619/15 F	104-105	RKWT 4-633/2 M	80-81	RKWT 8-6-268/2 M	78-79
RKWT 3U-619/20 F	104-105	RKWT 4-633/5 M	80-81	RKWT 8-6-268/5 M	78-79
RKWT 3U-664/6 F	100-101	RKWT 4-633/10 M	80-81	RKWT 8-6-268/10 M	78-79

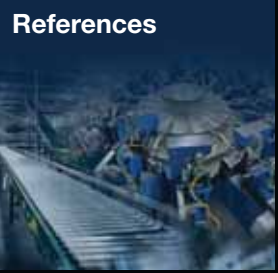

Part Number Index

Part Number	Page No.	Part Number	Page No.	Part Number	Page No.
RKWT 8-6-337/2 M	78-79	RKWT/LED P 4-251/2 M	82-83	RS 201-678/15 F	106-107
RKWT 8-6-337/5 M	78-79	RKWT/LED P 4-251/5 M	82-83	RS 201-678/20 F	106-107
RKWT 8-6-337/10 M	78-79	RKWT/LED P 4-251/10 M	82-83	RS 201-678/30 F	106-107
RKWT 8-282/2 M	78-79	RKWT/LED P 4-633/1 M	84-85	RS 30-601/2 M	118-119
RKWT 8-282/5 M	78-79	RKWT/LED P 4-633/2 M	84-85	RS 30-601/5 M	118-119
RKWT 8-282/10 M	78-79	RKWT/LED P 4-633/5 M	84-85	RS 30-601/10 M	118-119
RKWT 8-627/2 M	80-81	RKWT/LED P 4-633/10 M	84-85	RS 30-645/2 M	114-115
RKWT 8-627/5 M	80-81	RKWT/LED P 4-679/1 M	84-85	RS 30-645/5 M	114-115
RKWT 8-627/10 M	80-81	RKWT/LED P 4-679/2 M	84-85	RS 30-645/10 M	114-115
RKWT 12-348/2 M	78-79	RKWT/LED P 4-679/5 M	84-85	RS 30-731/6 F	114-115
RKWT 12-348/5 M	78-79	RKWT/LED P 4-679/10 M	84-85	RS 30-731/12 F	114-115
RKWT 12-348/10 M	78-79	RKWT/LED W 4-265/2 M	82-83	RS 30-731/15 F	114-115
RKWT/LED A 4-3-06/2 M	82-83	RKWT/LED W 4-265/5 M	82-83	RS 30-731/20 F	114-115
RKWT/LED A 4-3-06/5 M	82-83	RKWT/LED W 4-265/10 M	82-83	RS 30-731/30 F	114-115
RKWT/LED A 4-3-06/10 M	82-83	RKWT 4-182/2 M	88-89	RS 301-619/6 F	106-107
RKWT/LED A 4-3-224/2 M	82-83	RKWT 4-182/5 M	88-89	RS 301-619/12 F	106-107
RKWT/LED A 4-3-224/5 M	82-83	RKWT 4-182/10 M	88-89	RS 301-619/15 F	106-107
RKWT/LED A 4-3-224/10 M	82-83	RKWT 4-288/2 M	88-89	RS 301-619/20 F	106-107
RKWT/LED A 4-3-260/2 M	82-83	RKWT 4-288/5 M	88-89	RS 301-619/30 F	106-107
RKWT/LED A 4-3-260/5 M	82-83	RKWT 4-288/10 M	88-89	RS 301-738/6 F	106-107
RKWT/LED A 4-3-260/10 M	82-83	RKWT 5-298/2 M	88-89	RS 301-738/12 F	106-107
RKWT/LED A 4-3-610/1 M	84-85	RKWT 5-298/5 M	88-89	RS 301-738/15 F	106-107
RKWT/LED A 4-3-610/2 M	84-85	RKWT 5-298/10 M	88-89	RS 301-738/20 F	106-107
RKWT/LED A 4-3-610/5 M	84-85	RKWT 8-299/2 M	88-89	RS 301-738/30 F	106-107
RKWT/LED A 4-3-610/10 M	84-85	RKWT 8-299/5 M	88-89	RS 301-741/6 F	110-111
RKWT/LED A 4-3-632/1 M	84-85	RKWT 8-299/10 M	88-89	RS 301-741/12 F	110-111
RKWT/LED A 4-3-632/2 M	84-85	RKWU 12-256/5 M	136-137	RS 301-741/15 F	110-111
RKWT/LED A 4-3-632/5 M	84-85	RKWU 12-256/10 M	136-137	RS 301-741/20 F	110-111
RKWT/LED A 4-3-632/10 M	84-85	RKWU 12-256/15 M	136-137	RS 301-741/30 F	110-111
RKWT/LED C 4-3-610/1 M	84-85	RKWU 12-256/20 M	136-137	RS 40-602/2 M	114-115
RKWT/LED C 4-3-610/2 M	84-85	RKWU 19-242/5 M	136-137	RS 40-602/5 M	114-115
RKWT/LED C 4-3-610/5 M	84-85	RKWU 19-242/10 M	136-137	RS 40-602/10 M	114-115
RKWT/LED C 4-3-610/10 M	84-85	RKWU 19-242/15 M	136-137	RS 40-637/6 F	114-115
RKWT/LED C 4-3-632/1 M	84-85	RKWU 19-242/20 M	136-137	RS 40-637/12 F	114-115
RKWT/LED C 4-3-632/2 M	84-85	RKWUE 19-242/5 M	136-137	RS 40-637/15 F	114-115
RKWT/LED C 4-3-632/5 M	84-85	RKWUE 19-242/10 M	136-137	RS 40-637/20 F	114-115
RKWT/LED C 4-3-632/10 M	84-85	RKWUE 19-242/15 M	136-137	RS 40-637/30 F	114-115
RKWT/LED P 4-07/2 M	82-83	RKWUE 19-242/20 M	136-137	RS 401-739/6 F	106-107
RKWT/LED P 4-07/5 M	82-83	RS 20-603/2 M	114-115	RS 401-739/12 F	106-107
RKWT/LED P 4-07/10 M	82-83	RS 20-603/5 M	114-115	RS 401-739/15 F	106-107
RKWT/LED P 4-225/2 M	82-83	RS 20-603/10 M	114-115	RS 401-739/20 F	106-107
RKWT/LED P 4-225/5 M	82-83	RS 201-678/6 F	106-107	RS 401-739/30 F	106-107
RKWT/LED P 4-225/10 M	82-83	RS 201-678/12 F	106-107	RS 50-794/6 F	114-115

Part Number Index

Part Number	Page No.	Part Number	Page No.	Part Number	Page No.
RS 50-794/12 F	114-115	RS 801M-650/30 F	124-125	RS 1201M-728/20 F	130-131
RS 50-794/15 F	114-115	RS 801M-698/6 F	122-123	RS 1201M-728/30 F	130-131
RS 50-794/20 F	114-115	RS 801M-698/12 F	122-123	RS 1901M-669/2 M	132-133
RS 50-794/30 F	114-115	RS 801M-698/15 F	122-123	RS 1901M-669/5 M	132-133
RS 501-742/6 F	110-111	RS 801M-698/20 F	122-123	RS 1901M-669/10 M	132-133
RS 501-742/12 F	110-111	RS 801M-698/30 F	122-123	RS 1901M-669/15 M	132-133
RS 501-742/15 F	110-111	RS 901M-623/6 F	128-129	RSC 3/7	304-305
RS 501-742/20 F	110-111	RS 901M-623/12 F	128-129	RSC 3/9	304-305
RS 501-742/30 F	110-111	RS 901M-623/15 F	128-129	RSC 30/9	328-329
RS 501-755/6 F	110-111	RS 901M-623/20 F	128-129	RSC 30/11	328-329
RS 501-755/12 F	110-111	RS 901M-623/30 F	128-129	RSC 301/9	330-331
RS 501-755/15 F	110-111	RS 901M-651/6 F	126-127	RSC 301/11	330-331
RS 501-755/20 F	110-111	RS 901M-651/12 F	126-127	RSC 301/13.5	330-331
RS 501-755/30 F	110-111	RS 901M-651/15 F	126-127	RSC 301/16	330-331
RS 501-777/6 F	106-107	RS 901M-651/20 F	126-127	RSC 3U/7	324-325
RS 501-777/12 F	106-107	RS 901M-651/30 F	126-127	RSC 3U/9	324-325
RS 501-777/15 F	106-107	RS 1001M-652/6 F	126-127	RSC 4/7	304-305
RS 501-777/20 F	106-107	RS 1001M-652/12 F	126-127	RSC 4/9	304-305
RS 501-777/30 F	106-107	RS 1001M-652/15 F	126-127	RSC 4/DUO	316-317
RS 601A-697/6 F	106-107	RS 1001M-652/20 F	126-127	RSC 40/9	328-329
RS 601A-697/12 F	106-107	RS 1001M-652/30 F	126-127	RSC 401/9	330-331
RS 601A-697/15 F	106-107	RS 1001M-699/6 F	128-129	RSC 401/11	330-331
RS 601A-697/20 F	106-107	RS 1001M-699/12 F	128-129	RSC 401/13.5	330-331
RS 601A-697/30 F	106-107	RS 1001M-699/15 F	128-129	RSC 401/16	330-331
RS 601B-696/6 F	122-123	RS 1001M-699/20 F	128-129	RSC 5/7	304-305
RS 601B-696/12 F	122-123	RS 1001M-699/30 F	128-129	RSC 5/9	304-305
RS 601B-696/15 F	122-123	RS 1201M-654/6 F	126-127	RSC 5/DUO	316-317
RS 601B-696/20 F	122-123	RS 1201M-654/12 F	126-127	RSC 50/9	328-329
RS 601B-696/30 F	122-123	RS 1201M-654/15 F	126-127	RSC 50/11	328-329
RS 701M-622/6 F	122-123	RS 1201M-654/20 F	126-127	RSC 50/16	328-329
RS 701M-622/12 F	122-123	RS 1201M-654/30 F	126-127	RSC 501/9	330-331
RS 701M-622/15 F	122-123	RS 1201M-676/2 M	132-133	RSC 501/11	330-331
RS 701M-622/20 F	122-123	RS 1201M-676/5 M	132-133	RSC 501/13.5	330-331
RS 701M-622/30 F	122-123	RS 1201M-676/10 M	132-133	RSC 501/16	330-331
RS 701M-649/6 F	124-125	RS 1201M-676/15 M	132-133	RSC 8/9	304-305
RS 701M-649/12 F	124-125	RS 1201M-724/6 F	128-129	RSC 190/9	332-333
RS 701M-649/15 F	124-125	RS 1201M-724/12 F	128-129	RSC-F-120/13.5	332-333
RS 701M-649/20 F	124-125	RS 1201M-724/15 F	128-129	RSCN 4/7	312-313
RS 701M-649/30 F	124-125	RS 1201M-724/20 F	128-129	RSCN 4/9	312-313
RS 801M-650/6 F	124-125	RS 1201M-724/30 F	128-129	RSCN 4/DUO	318-319
RS 801M-650/12 F	124-125	RS 1201M-728/6 F	130-131	RSCN 5/7	312-313
RS 801M-650/15 F	124-125	RS 1201M-728/12 F	130-131	RSCN 5/9	312-313
RS 801M-650/20 F	124-125	RS 1201M-728/15 F	130-131	RSCN 8/9	312-313

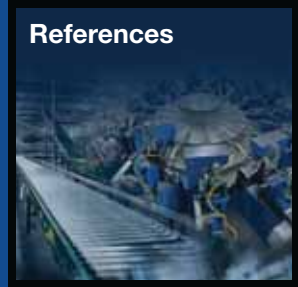

Be Certain with Belden

Part Number Index

Part Number	Page No.	Part Number	Page No.	Part Number	Page No.
RSCQ 3/7	310-311	RSF 30/11-01	280-281	RSFM 4	250-251
RSCQ 3/9	310-311	RSF 30/11-05	280-281	RSFM 4/0.5 M	260-261
RSCQ 4/7	310-311	RSF 30/13.5-01	280-281	RSFM 4/20/0.5 M	262-263
RSCQ 4/9	310-311	RSF 30/13.5-05	280-281	RSFM 5	250-251
RSCQS 3/9	322-323	RSF 30-601/0.3 M	288-289	RSFM 5/0.5 M	260-261
RSCQS 4/9	322-323	RSF 30-638/1F	282-283	RSFM 8/0.5 M	260-261
RSCS 4/9	320-321	RSF 30-641/1F	284-285	RSFPM 3/0,5 M	264-265
RSCS 5/9	320-321	RSF 30-695/0.3 M	286-287	RSFPM 4/0,5 M	264-265
RSCS 8/9	320-321	RSF 4 U/1F	276-277	RSFPM 5/0,5 M	264-265
RSCW 3/7	306-307	RSF 4/0.5M	254-255	RSFPM 8/0,5 M	264-265
RSCW 3/9	306-307	RSF 4-1/2-14/0.5 M	258-259	RSHL 4/S 5.5	248-249
RSCW 3U/7	326-327	RSF 4-S3103/0.5 M	256-257	RSHL 5/S 5.5	248-249
RSCW 3U/9	326-327	RSF 40/11-02	280-281	RSHL 8/S 5,5	248-249
RSCW 4/7	306-307	RSF 40/13.5-02	280-281	RSKF 8	237
RSCW 4/9	306-307	RSF 40-639/1F	282-283	RSKF 9	237
RSCW 5/7	306-307	RSF 40-693/0.3 M	286-287	RSKF 11	237
RSCW 5/9	306-307	RSF 5 TB	270-271	RSKF 13.5	237
RSCW 8/9	306-307	RSF 5-S3103/0.5 M	256-257	RSKFM 16	237
RSCWN 4/7	314-315	RSF 5 U/1F	276-277	RSKFM 20	237
RSCWN 4/9	314-315	RSF 5/0.5M	254-255	RSM 8-354/2 M	62-63
RSCWN 5/7	314-315	RSF 5-1/2-14/0.5 M	258-259	RSM 8-354/5 M	62-63
RSCWN 5/9	314-315	RSF 50/11-04	280-281	RSM 8-354/10 M	62-63
RSE 3 U	278-279	RSF 50/13.5-04	280-281	RSMC 3	298-299
RSE 4	272-273	RSF 50-642/1F	284-285	RSMC 4	298-299
RSE 4 L	272-273	RSF 50-677/1F	282-283	RSMCK 3	302-303
RSE 4 U	278-279	RSF 50-690/1F	284-285	RSMCK 4	302-303
RSE 5	272-273	RSF 50-694/0.3 M	286-287	RSMCW 3	300-301
RSE 5 U	278-279	RSF 60A-697/1F	282-283	RSMCW 4	300-301
RSEL 4	274-275	RSF 60B-696/1F	290-291	RSME 3	240-241
RSEL 5	274-275	RSF 70M-622/1F	290-291	RSMEB 3	244-245
RSEL 8	274-275	RSF 8-S3103/0.5 M	256-257	RSMEB 4	244-245
RSELP 4	274-275	RSF 8/0.5M	254-255	RSMED 3	244-245
RSELP 5	274-275	RSF 8-1/2-14/0.5M	258-259	RSMED 4	244-245
RSEM 8	242-243	RSF 80M-698/1F	290-291	RSMEDG 8	246-247
RSEQ 5	272-273	RSF 90M-623/1F	292-293	RSMEDGN 3	246-247
RSF 20/11-03	280-281	RSF 100M-699/1F	292-293	RSMEDGN 4	246-247
RSF 20/13.5-03	280-281	RSF 120M-624/1F	292-293	RSMEH 3	244-245
RSF 20-603/0.3 M	286-287	RSF 120M-630/0.3M	294-295	RSMEH 4	244-245
RSF 20-678/1F	282-283	RSF 120M-676/1F	296-297	RSMEJ 3	244-245
RSF 3 U/1F	276-277	RSF 190M-669/1F	296-297	RSMEK 3L	240-241
RSF 3-1/2-14/0.5 M	258-259	RSFM 3	250-251	RSMEK 4	240-241
RSF 3-S3103/0.5 M	256-257	RSFM 3/0.5 M	260-261	RSMF 3/0,5 M	238-239
RSF 3/0.5 M	254-255	RSFM 3/20/0.5 M	262-263	RSMF 4/0,5 M	238-239

Part Number Index

Part Number	Page No.	Part Number	Page No.	Part Number	Page No.
RSMF 8/0,5 M	238-239	RSMWV 4-07/5 M	60-61	RSRK 40-602/0.3 M	170-171
RSMHL 3/S 5.5	236-237	RSMWV 4-07/10 M	60-61	RSRK 40-602/0.6 M	170-171
RSMHL 4/S 5.5	236-237	RSMWV 4-225/2 M	60-61	RSRK 40-602/1 M	170-171
RSMV 3-06/2 M	60-61	RSMWV 4-225/5 M	60-61	RSRK 40-602/2 M	170-171
RSMV 3-06/5 M	60-61	RSMWV 4-225/10 M	60-61	RSRK 40-602/5 M	170-171
RSMV 3-06/10 M	60-61	RSRK 20-603/0.3 M	170-171	RSRK 40-637/6 F	170-171
RSMV 3-224/2 M	60-61	RSRK 20-603/0.6 M	170-171	RSRK 40-637/12 F	170-171
RSMV 3-224/5 M	60-61	RSRK 20-603/1 M	170-171	RSRK 40-637/15 F	170-171
RSMV 3-224/10 M	60-61	RSRK 20-603/2 M	170-171	RSRK 40-637/20 F	170-171
RSMV 3-RKM 3-224/0.6 M	138-139	RSRK 20-603/5 M	170-171	RSRK 40-637/30 F	170-171
RSMV 3-RKM 3-224/1 M	138-139	RSRK 201-678/6 F	166-167	RSRK 401-739/6 F	166-167
RSMV 3-RKM 3-224/2 M	138-139	RSRK 201-678/12 F	166-167	RSRK 401-739/12 F	166-167
RSMV 3-RKMV 3-224/0.6 M	138-139	RSRK 201-678/15 F	166-167	RSRK 401-739/15 F	166-167
RSMV 3-RKMV 3-224/1 M	138-139	RSRK 201-678/20 F	166-167	RSRK 401-739/20 F	166-167
RSMV 3-RKMV 3-224/2 M	138-139	RSRK 201-678/30 F	166-167	RSRK 401-739/30 F	166-167
RSMV 3-RKMWV 3-224/0.6 M	140-141	RSRK 30-601/2 M	172-173	RSRK 50-794/6 F	170-171
RSMV 3-RKMWV 3-224/1 M	140-141	RSRK 30-601/5 M	172-173	RSRK 50-794/12 F	170-171
RSMV 3-RKMWV 3-224/2 M	140-141	RSRK 30-601/10 M	172-173	RSRK 50-794/15 F	170-171
RSMV 3-RKMWV/LED A 3-224/0.6 M	140-141	RSRK 30-645/0.3 M	170-171	RSRK 50-794/20 F	170-171
RSMV 3-RKMWV/LED A 3-224/1 M	140-141	RSRK 30-645/0.6 M	170-171	RSRK 50-794/30 F	170-171
RSMV 3-RKMWV/LED A 3-224/2 M	140-141	RSRK 30-645/1 M	170-171	RSRK 501-742/6 F	168-169
RSMV 3-RKT 4-3-224/0.6 M	142-143	RSRK 30-645/2 M	170-171	RSRK 501-742/12 F	168-169
RSMV 3-RKT 4-3-224/1 M	142-143	RSRK 30-645/5 M	170-171	RSRK 501-742/15 F	168-169
RSMV 3-RKT 4-3-224/2 M	142-143	RSRK 30-731/6 F	170-171	RSRK 501-742/20 F	168-169
RSMV 3-RKWT 4-3-224/0.6 M	142-143	RSRK 30-731/12 F	170-171	RSRK 501-742/30 F	168-169
RSMV 3-RKWT 4-3-224/1 M	142-143	RSRK 30-731/15 F	170-171	RSRK 501-755/6 F	168-169
RSMV 3-RKWT 4-3-224/2 M	142-143	RSRK 30-731/20 F	170-171	RSRK 501-755/12 F	168-169
RSMV 3-RKWT/LED A 4-3-224/0.6 M	144-145	RSRK 30-731/30 F	170-171	RSRK 501-755/15 F	168-169
RSMV 3-RKWT/LED A 4-3-224/1 M	144-145	RSRK 301-619/6 F	166-167	RSRK 501-755/20 F	168-169
RSMV 3-RKWT/LED A 4-3-224/2 M	144-145	RSRK 301-619/12 F	166-167	RSRK 501-755/30 F	168-169
RSMV 4-07/2 M	60-61	RSRK 301-619/15 F	166-167	RSRK 501-777/6 F	166-167
RSMV 4-07/5 M	60-61	RSRK 301-619/20 F	166-167	RSRK 501-777/12 F	166-167
RSMV 4-07/10 M	60-61	RSRK 301-619/30 F	166-167	RSRK 501-777/15 F	166-167
RSMV 4-225/2 M	60-61	RSRK 301-738/6 F	166-167	RSRK 501-777/20 F	166-167
RSMV 4-225/5 M	60-61	RSRK 301-738/12 F	166-167	RSRK 501-777/30 F	166-167
RSMV 4-225/10 M	60-61	RSRK 301-738/15 F	166-167	RSRK 601A-697/6 F	166-167
RSMWV 3-06/2 M	60-61	RSRK 301-738/20 F	166-167	RSRK 601A-697/12 F	166-167
RSMWV 3-06/5 M	60-61	RSRK 301-738/30 F	166-167	RSRK 601A-697/15 F	166-167
RSMWV 3-06/10 M	60-61	RSRK 301-741/6 F	168-169	RSRK 601A-697/20 F	166-167
RSMWV 3-224/2 M	60-61	RSRK 301-741/12 F	168-169	RSRK 601A-697/30 F	166-167
RSMWV 3-224/5 M	60-61	RSRK 301-741/15 F	168-169	RSRK 601B-696/6 F	174-175
RSMWV 3-224/10 M	60-61	RSRK 301-741/20 F	168-169	RSRK 601B-696/12 F	174-175
RSMWV 4-07/2 M	60-61	RSRK 301-741/30 F	168-169	RSRK 601B-696/15 F	174-175

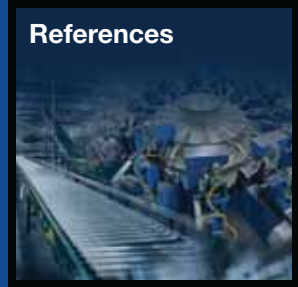

Be Certain with Belden

Part Number Index

Part Number	Page No.	Part Number	Page No.	Part Number	Page No.
RSRK 601B-696/20 F	174-175	RSRK 1201M-654/12 F	180-181	RSRKW 30-738/6 F	166-167
RSRK 601B-696/30 F	174-175	RSRK 1201M-654/15 F	180-181	RSRKW 30-738/12 F	166-167
RSRK 701M-622/6 F	174-175	RSRK 1201M-654/20 F	180-181	RSRKW 30-738/15 F	166-167
RSRK 701M-622/12 F	174-175	RSRK 1201M-654/30 F	180-181	RSRKW 30-738/20 F	166-167
RSRK 701M-622/15 F	174-175	RSRK 1201M-676/1 M	182-183	RSRKW 30-738/30 F	166-167
RSRK 701M-622/20 F	174-175	RSRK 1201M-676/2 M	182-183	RSRKW 301-619/6 F	166-167
RSRK 701M-622/30 F	174-175	RSRK 1201M-676/3 M	182-183	RSRKW 301-619/12 F	166-167
RSRK 701M-649/6 F	176-177	RSRK 1201M-676/5 M	182-183	RSRKW 301-619/15 F	166-167
RSRK 701M-649/12 F	176-177	RSRK 1201M-724/6 F	180-181	RSRKW 301-619/20 F	166-167
RSRK 701M-649/15 F	176-177	RSRK 1201M-724/12 F	180-181	RSRKW 301-619/30 F	166-167
RSRK 701M-649/20 F	176-177	RSRK 1201M-724/15 F	180-181	RSRKW 301-741/6 F	168-169
RSRK 701M-649/30 F	176-177	RSRK 1201M-724/20 F	180-181	RSRKW 301-741/12 F	168-169
RSRK 801M-650/6 F	176-177	RSRK 1201M-724/30 F	180-181	RSRKW 301-741/15 F	168-169
RSRK 801M-650/12 F	176-177	RSRK 1201M-728/6 F	178-179	RSRKW 301-741/20 F	168-169
RSRK 801M-650/15 F	176-177	RSRK 1201M-728/12 F	178-179	RSRKW 301-741/30 F	168-169
RSRK 801M-650/20 F	176-177	RSRK 1201M-728/15 F	178-179	RSRKW 40-602/0.3 M	170-171
RSRK 801M-650/30 F	176-177	RSRK 1201M-728/20 F	178-179	RSRKW 40-602/0.6 M	170-171
RSRK 801M-698/6 F	174-175	RSRK 1201M-728/30 F	178-179	RSRKW 40-602/1 M	170-171
RSRK 801M-698/12 F	174-175	RSRK 1901M-669/2 M	182-183	RSRKW 40-602/2 M	170-171
RSRK 801M-698/15 F	174-175	RSRK 1901M-669/5 M	182-183	RSRKW 40-602/5 M	170-171
RSRK 801M-698/20 F	174-175	RSRKW 20-603/0.3 M	170-171	RSRKW 40-637/6 F	170-171
RSRK 801M-698/30 F	174-175	RSRKW 20-603/0.6 M	170-171	RSRKW 40-637/12 F	170-171
RSRK 901M-623/6 F	180-181	RSRKW 20-603/1 M	170-171	RSRKW 40-637/15 F	170-171
RSRK 901M-623/12 F	180-181	RSRKW 20-603/2 M	170-171	RSRKW 40-637/20 F	170-171
RSRK 901M-623/15 F	180-181	RSRKW 20-603/5 M	170-171	RSRKW 40-637/30 F	170-171
RSRK 901M-623/20 F	180-181	RSRKW 201-678/6 F	166-167	RSRKW 401-739/6 F	166-167
RSRK 901M-623/30 F	180-181	RSRKW 201-678/12 F	166-167	RSRKW 401-739/12 F	166-167
RSRK 901M-651/6 F	180-181	RSRKW 201-678/15 F	166-167	RSRKW 401-739/15 F	166-167
RSRK 901M-651/12 F	180-181	RSRKW 201-678/20 F	166-167	RSRKW 401-739/20 F	166-167
RSRK 901M-651/15 F	180-181	RSRKW 201-678/30 F	166-167	RSRKW 401-739/30 F	166-167
RSRK 901M-651/20 F	180-181	RSRKW 30-601/2 M	172-173	RSRKW 50-794/6 F	170-171
RSRK 901M-651/30 F	180-181	RSRKW 30-601/5 M	172-173	RSRKW 50-794/12 F	170-171
RSRK 1001M-652/6 F	180-181	RSRKW 30-601/10 M	172-173	RSRKW 50-794/15 F	170-171
RSRK 1001M-652/12 F	180-181	RSRKW 30-645/0.3 M	170-171	RSRKW 50-794/20 F	170-171
RSRK 1001M-652/15 F	180-181	RSRKW 30-645/0.6 M	170-171	RSRKW 50-794/30 F	170-171
RSRK 1001M-652/20 F	180-181	RSRKW 30-645/1 M	170-171	RSRKW 501-742/6 F	168-169
RSRK 1001M-652/30 F	180-181	RSRKW 30-645/2 M	170-171	RSRKW 501-742/12 F	168-169
RSRK 1001M-699/6 F	180-181	RSRKW 30-645/5 M	170-171	RSRKW 501-742/15 F	168-169
RSRK 1001M-699/12 F	180-181	RSRKW 30-731/6 F	170-171	RSRKW 501-742/20 F	168-169
RSRK 1001M-699/15 F	180-181	RSRKW 30-731/12 F	170-171	RSRKW 501-742/30 F	168-169
RSRK 1001M-699/20 F	180-181	RSRKW 30-731/15 F	170-171	RSRKW 501-755/6 F	168-169
RSRK 1001M-699/30 F	180-181	RSRKW 30-731/20 F	170-171	RSRKW 501-755/12 F	168-169
RSRK 1201M-654/6 F	180-181	RSRKW 30-731/30 F	170-171	RSRKW 501-755/15 F	168-169

Part Number Index

Part Number	Page No.	Part Number	Page No.	Part Number	Page No.
RSRKW 501-755/20 F	168-169	RST 3-RKMV 3-224/2 M	146-147	RST 3-RKWT 4-3-632/5 M	154-155
RSRKW 501-755/30 F	168-169	RST 3-RKMV 3-224/5 M	146-147	RST 3-RKWT 4-3-645/10 M	154-155
RSRKW 501-777/6 F	166-167	RST 3-RKMV/LED A 3-224/0.3 M	148-149	RST 3-RKWT 4-3-645/2 M	154-155
RSRKW 501-777/12 F	166-167	RST 3-RKMV/LED A 3-224/0.6 M	148-149	RST 3-RKWT 4-3-645/5 M	154-155
RSRKW 501-777/15 F	166-167	RST 3-RKMV/LED A 3-224/1 M	148-149	RST 3-RKWT 4-3-731/2 M	154-155
RSRKW 501-777/20 F	166-167	RST 3-RKMV/LED A 3-224/1.5 M	148-149	RST 3-RKWT 4-3-731/5 M	154-155
RSRKW 501-777/30 F	166-167	RST 3-RKMV/LED A 3-224/2 M	148-149	RST 3-RKWT 4-3-731/10 M	154-155
RSRKW 601A-697/6 F	166-167	RST 3-RKMV/LED A 3-224/5 M	148-149	RST 3-RKWT/LED A 4-3-224/0.3 M	156-157
RSRKW 601A-697/12 F	166-167	RST 3-RKMV/LED A 3-224/0.3 M	148-149	RST 3-RKWT/LED A 4-3-224/0.6 M	156-157
RSRKW 601A-697/15 F	166-167	RST 3-RKMV/LED A 3-224/0.6 M	148-149	RST 3-RKWT/LED A 4-3-224/1 M	156-157
RSRKW 601A-697/20 F	166-167	RST 3-RKMV/LED A 3-224/1 M	148-149	RST 3-RKWT/LED A 4-3-224/1.5 M	156-157
RSRKW 601A-697/30 F	166-167	RST 3-RKMV/LED A 3-224/1.5 M	148-149	RST 3-RKWT/LED A 4-3-224/2 M	156-157
RST 3-06/2 M	74-75	RST 3-RKMV/LED A 3-224/2 M	148-149	RST 3-RKWT/LED A 4-3-224/5 M	156-157
RST 3-06/5 M	74-75	RST 3-RKMV/LED A 3-224/5 M	148-149	RST 3-RKWT/LED A 4-3-260/0.3 M	156-157
RST 3-06/10 M	74-75	RST 3-RKT 4-3-224/0.3 M	150-151	RST 3-RKWT/LED A 4-3-260/0.6 M	156-157
RST 3-224/2 M	74-75	RST 3-RKT 4-3-224/0.6 M	150-151	RST 3-RKWT/LED A 4-3-260/1 M	156-157
RST 3-224/5 M	74-75	RST 3-RKT 4-3-224/1 M	150-151	RST 3-RKWT/LED A 4-3-260/1.5 M	156-157
RST 3-224/10 M	74-75	RST 3-RKT 4-3-224/1.5 M	150-151	RST 3-RKWT/LED A 4-3-260/2 M	156-157
RST 3-260/2 M	74-75	RST 3-RKT 4-3-224/2 M	150-151	RST 3-RKWT/LED A 4-3-260/5 M	156-157
RST 3-260/5 M	74-75	RST 3-RKT 4-3-224/5 M	150-151	RST 3U-226/5 M	96-97
RST 3-260/10 M	74-75	RST 3-RKT 4-3-610/10 M	154-155	RST 3U-618/6 F	98-99
RST 3-610/2 M	76-77	RST 3-RKT 4-3-610/2 M	154-155	RST 3U-618/12 F	98-99
RST 3-610/5 M	76-77	RST 3-RKT 4-3-610/5 M	154-155	RST 3U-618/15 F	98-99
RST 3-610/10 M	76-77	RST 3-RKT 4-3-632/10 M	154-155	RST 3U-618/20 F	98-99
RST 3-632/2 M	76-77	RST 3-RKT 4-3-632/2 M	154-155	RST 3U-619/6 F	102-103
RST 3-632/5 M	76-77	RST 3-RKT 4-3-632/5 M	154-155	RST 3U-619/12 F	102-103
RST 3-632/10 M	76-77	RST 3-RKT 4-3-645/10 M	154-155	RST 3U-61915 F	102-103
RST 3-645/2 M	76-77	RST 3-RKT 4-3-645/2 M	154-155	RST 3U-619/20 F	102-103
RST 3-645/5 M	76-77	RST 3-RKT 4-3-645/5 M	154-155	RST 3U-664/6 F	98-99
RST 3-645/10 M	76-77	RST 3-RKT 4-3-731/10 M	154-155	RST 3U-664/12 F	98-99
RST 3-731/2 M	76-77	RST 3-RKT 4-3-731/2 M	154-155	RST 3U-664/15 F	98-99
RST 3-731/5 M	76-77	RST 3-RKT 4-3-731/5 M	154-155	RST 3U-664/20 F	98-99
RST 3-731/10 M	76-77	RST 3-RKWT 4-3-224/0.3 M	150-151	RST 3U-688/6 F	98-99
RST 3-RKM 3-224/0.3 M	146-147	RST 3-RKWT 4-3-224/0.6 M	150-151	RST 3U-688/12 F	98-99
RST 3-RKM 3-224/0.6 M	146-147	RST 3-RKWT 4-3-224/1 M	150-151	RST 3U-688/15 F	98-99
RST 3-RKM 3-224/1 M	146-147	RST 3-RKWT 4-3-224/1.5 M	150-151	RST 3U-688/20 F	98-99
RST 3-RKM 3-224/1.5 M	146-147	RST 3-RKWT 4-3-224/2 M	150-151	RST 3U-RKT 3U-618/3 F	162-163
RST 3-RKM 3-224/2 M	146-147	RST 3-RKWT 4-3-224/5 M	150-151	RST 3U-RKT 3U-618/6 F	162-163
RST 3-RKM 3-224/5 M	146-147	RST 3-RKWT 4-3-610/10 M	154-155	RST 3U-RKT 3U-618/12 F	162-163
RST 3-RKMV 3-224/0.3 M	146-147	RST 3-RKWT 4-3-610/2 M	154-155	RST 3U-RKT 3U-618/15 F	162-163
RST 3-RKMV 3-224/0.6 M	146-147	RST 3-RKWT 4-3-610/5 M	154-155	RST 3U-RKT 3U-619/3 F	164-165
RST 3-RKMV 3-224/1 M	146-147	RST 3-RKWT 4-3-632/10 M	154-155	RST 3U-RKT 3U-619/6 F	164-165
RST 3-RKMV 3-224/1.5 M	146-147	RST 3-RKWT 4-3-632/2 M	154-155	RST 3U-RKT 3U-619/12 F	164-165

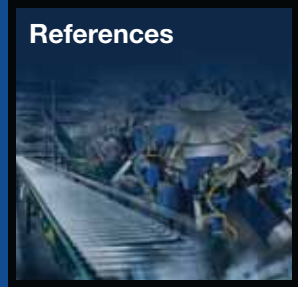

Be Certain with Belden

Part Number Index

Part Number	Page No.	Part Number	Page No.	Part Number	Page No.
RST 3U-RKT 3U-619/15 F	164-165	RST 4-643/2 M	76-77	RST 4-RKWT 4-633/5 M	154-155
RST 3U-RKT 3U-664/3 F	162-163	RST 4-643/5 M	76-77	RST 4-RKWT 4-633/10 M	154-155
RST 3U-RKT 3U-664/6 F	162-163	RST 4-643/10 M	76-77	RST 4-RKWT 4-637/2 M	154-155
RST 3U-RKT 3U-664/12 F	162-163	RST 4-679/2 M	76-77	RST 4-RKWT 4-637/5 M	154-155
RST 3U-RKT 3U-664/15 F	162-163	RST 4-679/5 M	76-77	RST 4-RKWT 4-637/10 M	154-155
RST 3U-RKT 3U-688/3 F	162-163	RST 4-679/10 M	76-77	RST 4-RKWT 4-643/2 M	154-155
RST 3U-RKT 3U-688/6 F	162-163	RST 4-RKT 4-225/0.3 M	150-151	RST 4-RKWT 4-643/5 M	154-155
RST 3U-RKT 3U-688/12 F	162-163	RST 4-RKT 4-225/0.6 M	150-151	RST 4-RKWT 4-643/10 M	154-155
RST 3U-RKT 3U-688/15 F	162-163	RST 4-RKT 4-225/1 M	150-151	RST 4-RKWT 4-679/2 M	154-155
RST 3U-RKWT 3U-618/3 F	162-163	RST 4-RKT 4-225/1.5 M	150-151	RST 4-RKWT 4-679/5 M	154-155
RST 3U-RKWT 3U-618/6 F	162-163	RST 4-RKT 4-225/2 M	150-151	RST 4-RKWT 4-679/10 M	154-155
RST 3U-RKWT 3U-618/12 F	162-163	RST 4-RKT 4-225/5 M	150-151	RST 4-RKWT/LED P 4-225/0.3 M	156-157
RST 3U-RKWT 3U-618/15 F	162-163	RST 4-RKT 4-251/0.3 M	150-151	RST 4-RKWT/LED P 4-225/0.6 M	156-157
RST 3U-RKWT 3U-619/3 F	164-165	RST 4-RKT 4-251/0.6 M	150-151	RST 4-RKWT/LED P 4-225/1 M	156-157
RST 3U-RKWT 3U-619/6 F	164-165	RST 4-RKT 4-251/1 M	150-151	RST 4-RKWT/LED P 4-225/1.5 M	156-157
RST 3U-RKWT 3U-619/12 F	164-165	RST 4-RKT 4-251/1.5 M	150-151	RST 4-RKWT/LED P 4-225/2 M	156-157
RST 3U-RKWT 3U-619/15 F	164-165	RST 4-RKT 4-251/2 M	150-151	RST 4-RKWT/LED P 4-225/5 M	156-157
RST 3U-RKWT 3U-664/3 F	162-163	RST 4-RKT 4-251/5 M	150-151	RST 4-RKWT/LED P 4-251/0.3 M	156-157
RST 3U-RKWT 3U-664/6 F	162-163	RST 4-RKT 4-602/10 M	154-155	RST 4-RKWT/LED P 4-251/0.6 M	156-157
RST 3U-RKWT 3U-664/12 F	162-163	RST 4-RKT 4-602/2 M	154-155	RST 4-RKWT/LED P 4-251/1 M	156-157
RST 3U-RKWT 3U-664/15 F	162-163	RST 4-RKT 4-602/5 M	154-155	RST 4-RKWT/LED P 4-251/1.5 M	156-157
RST 3U-RKWT 3U-688/3 F	162-163	RST 4-RKT 4-633/10 M	154-155	RST 4-RKWT/LED P 4-251/2 M	156-157
RST 3U-RKWT 3U-688/6 F	162-163	RST 4-RKT 4-633/2 M	154-155	RST 4-RKWT/LED P 4-251/5 M	156-157
RST 3U-RKWT 3U-688/12 F	162-163	RST 4-RKT 4-633/5 M	154-155	RST 4-RKWT/LED R 4-251/0.3 M	156-157
RST 3U-RKWT 3U-688/15 F	162-163	RST 4-RKT 4-637/10 M	154-155	RST 4-RKWT/LED R 4-251/0.6 M	156-157
RST 4-07/2 M	74-75	RST 4-RKT 4-637/2 M	154-155	RST 4-RKWT/LED R 4-251/1 M	156-157
RST 4-07/5 M	74-75	RST 4-RKT 4-637/5 M	154-155	RST 4-RKWT/LED R 4-251/1.5 M	156-157
RST 4-07/10 M	74-75	RST 4-RKT 4-643/10 M	154-155	RST 4-RKWT/LED R 4-251/2 M	156-157
RST 4-225/2 M	74-75	RST 4-RKT 4-643/2 M	154-155	RST 4-RKWT/LED R 4-251/5 M	156-157
RST 4-225/5 M	74-75	RST 4-RKT 4-643/5 M	154-155	RST 4U-674/6 F	98-99
RST 4-225/10 M	74-75	RST 4-RKT 4-679/2 M	154-155	RST 4U-674/12 F	98-99
RST 4-251/2 M	74-75	RST 4-RKT 4-679/5 M	154-155	RST 4U-674/15 F	98-99
RST 4-251/5 M	74-75	RST 4-RKT 4-679/10 M	154-155	RST 4U-674/20 F	98-99
RST 4-251/10 M	74-75	RST 4-RKWT 4-225/0.3 M	150-151	RST 4U-689/6 F	98-99
RST 4-602/2 M	76-77	RST 4-RKWT 4-225/0.6 M	150-151	RST 4U-689/12 F	98-99
RST 4-602/5 M	76-77	RST 4-RKWT 4-225/1 M	150-151	RST 4U-689/15 F	98-99
RST 4-602/10 M	76-77	RST 4-RKWT 4-225/1.5 M	150-151	RST 4U-689/20 F	98-99
RST 4-633/2 M	76-77	RST 4-RKWT 4-225/2 M	150-151	RST 4U-RKT 4U-674/3 F	162-163
RST 4-633/5 M	76-77	RST 4-RKWT 4-225/5 M	150-151	RST 4U-RKT 4U-674/6 F	162-163
RST 4-633/10 M	76-77	RST 4-RKWT 4-602/2 M	154-155	RST 4U-RKT 4U-674/12 F	162-163
RST 4-637/2 M	76-77	RST 4-RKWT 4-602/5 M	154-155	RST 4U-RKT 4U-674/15 F	162-163
RST 4-637/5 M	76-77	RST 4-RKWT 4-602/10 M	154-155	RST 4U-RKT 4U-689/3 F	162-163
RST 4-637/10 M	76-77	RST 4-RKWT 4-633/2 M	154-155	RST 4U-RKT 4U-689/6 F	162-163

Part Number Index

Part Number	Page No.	Part Number	Page No.	Part Number	Page No.
RST 4U-RKT 4U-689/12 F	162-163	RST 5-3-VB 1A-1-1-226/1.5 M	188-189	RST 5-3-VCD 1A-1-3-226/2 M	190-191
RST 4U-RKT 4U-689/15 F	162-163	RST 5-3-VB 1A-1-1-226/2 M	188-189	RST 5-3-VCD 1A-1-3-226/5 M	190-191
RST 4U-RKWT 4U-689/3 F	162-163	RST 5-3-VB 1A-1-1-226/5 M	188-189	RST 5-3-VCD 1A-1-3-241/0.3 M	190-191
RST 4U-RKWT 4U-689/6 F	162-163	RST 5-3-VB 1A-1-2-226/0.3 M	188-189	RST 5-3-VCD 1A-1-3-241/0.6 M	190-191
RST 4U-RKWT 4U-689/12 F	162-163	RST 5-3-VB 1A-1-2-226/0.6 M	188-189	RST 5-3-VCD 1A-1-3-241/1 M	190-191
RST 4U-RKWT 4U-689/15 F	162-163	RST 5-3-VB 1A-1-2-226/1 M	188-189	RST 5-3-VCD 1A-1-3-241/1.5 M	190-191
RST 4U-RKWT 4U-674/3 F	162-163	RST 5-3-VB 1A-1-2-226/1.5 M	188-189	RST 5-3-VCD 1A-1-3-241/2 M	190-191
RST 4U-RKWT 4U-674/6 F	162-163	RST 5-3-VB 1A-1-2-226/2 M	188-189	RST 5-3-VCD 1A-1-3-241/5 M	190-191
RST 4U-RKWT 4U-674/12 F	162-163	RST 5-3-VB 1A-1-2-226/5 M	188-189	RST 5-56/2 M	74-75
RST 4U-RKWT 4U-674/15 F	162-163	RST 5-3-VBD 1A-1-1-226/0.3 M	188-189	RST 5-56/5 M	74-75
RST 5-228/2 M	74-75	RST 5-3-VBD 1A-1-1-226/0.6 M	188-189	RST 5-56/10 M	74-75
RST 5-228/5 M	74-75	RST 5-3-VBD 1A-1-1-226/1 M	188-189	RST 5-612/2 M	76-77
RST 5-228/10 M	74-75	RST 5-3-VBD 1A-1-1-226/1.5 M	188-189	RST 5-612/5 M	76-77
RST 5-259/2 M	74-75	RST 5-3-VBD 1A-1-1-226/2 M	188-189	RST 5-612/10 M	76-77
RST 5-259/5 M	74-75	RST 5-3-VBD 1A-1-1-226/5 M	188-189	RST 5-644/2 M	76-77
RST 5-259/10 M	74-75	RST 5-3-VBD 1A-1-1-241/0.3 M	188-189	RST 5-644/5 M	76-77
RST 5-3-VAD 1A-1-3-226/0.3 M	186-187	RST 5-3-VBD 1A-1-1-241/0.6 M	188-189	RST 5-644/10 M	76-77
RST 5-3-VAD 1A-1-3-226/0.6 M	186-187	RST 5-3-VBD 1A-1-1-241/1 M	188-189	RST 5-RKT 5-228/0.3 M	150-151
RST 5-3-VAD 1A-1-3-226/1 M	186-187	RST 5-3-VBD 1A-1-1-241/1.5 M	188-189	RST 5-RKT 5-228/0.6 M	150-151
RST 5-3-VAD 1A-1-3-226/1.5 M	186-187	RST 5-3-VBD 1A-1-1-241/2 M	188-189	RST 5-RKT 5-228/1 M	150-151
RST 5-3-VAD 1A-1-3-226/2 M	186-187	RST 5-3-VBD 1A-1-1-241/5 M	188-189	RST 5-RKT 5-228/1.5 M	150-151
RST 5-3-VAD 1A-1-3-226/5 M	186-187	RST 5-3-VBD 1A-1-2-226/0.3 M	188-189	RST 5-RKT 5-228/2 M	150-151
RST 5-3-VAD 1A-1-3-241/0.3 M	186-187	RST 5-3-VBD 1A-1-2-226/0.6 M	188-189	RST 5-RKT 5-228/5 M	150-151
RST 5-3-VAD 1A-1-3-241/0.6 M	186-187	RST 5-3-VBD 1A-1-2-226/1 M	188-189	RST 5-RKT 5-259/0.3 M	150-151
RST 5-3-VAD 1A-1-3-241/1 M	186-187	RST 5-3-VBD 1A-1-2-226/1.5 M	188-189	RST 5-RKT 5-259/0.6 M	150-151
RST 5-3-VAD 1A-1-3-241/1.5 M	186-187	RST 5-3-VBD 1A-1-2-226/2 M	188-189	RST 5-RKT 5-259/1 M	150-151
RST 5-3-VAD 1A-1-3-241/2 M	186-187	RST 5-3-VBD 1A-1-2-226/5 M	188-189	RST 5-RKT 5-259/1.5 M	150-151
RST 5-3-VAD 1A-1-3-241/5 M	186-187	RST 5-3-VBD 1A-1-2-241/0.3 M	188-189	RST 5-RKT 5-259/2 M	150-151
RST 5-3-VAD 1F-4-3-226/0.3 M	186-187	RST 5-3-VBD 1A-1-2-241/0.6 M	188-189	RST 5-RKT 5-259/5 M	150-151
RST 5-3-VAD 1F-4-3-226/0.6 M	186-187	RST 5-3-VBD 1A-1-2-241/1 M	188-189	RST 5-RKT 5-612/2 M	154-155
RST 5-3-VAD 1F-4-3-226/1 M	186-187	RST 5-3-VBD 1A-1-2-241/1.5 M	188-189	RST 5-RKT 5-612/5 M	154-155
RST 5-3-VAD 1F-4-3-226/1.5 M	186-187	RST 5-3-VBD 1A-1-2-241/2 M	188-189	RST 5-RKT 5-612/10 M	154-155
RST 5-3-VAD 1F-4-3-226/2 M	186-187	RST 5-3-VBD 1A-1-2-241/5 M	188-189	RST 5-RKT 5-644/2 M	154-155
RST 5-3-VAD 1F-4-3-226/5 M	186-187	RST 5-3-VC 1A-1-3-226/0.3 M	190-191	RST 5-RKT 5-644/5 M	154-155
RST 5-3-VAD 1F-4-3-241/0.3 M	186-187	RST 5-3-VC 1A-1-3-226/0.6 M	190-191	RST 5-RKT 5-644/10 M	154-155
RST 5-3-VAD 1F-4-3-241/0.6 M	186-187	RST 5-3-VC 1A-1-3-226/1 M	190-191	RST 5-RKWT 5-612/2 M	154-155
RST 5-3-VAD 1F-4-3-241/1 M	186-187	RST 5-3-VC 1A-1-3-226/1.5 M	190-191	RST 5-RKWT 5-612/5 M	154-155
RST 5-3-VAD 1F-4-3-241/1.5 M	186-187	RST 5-3-VC 1A-1-3-226/2 M	190-191	RST 5-RKWT 5-612/10 M	154-155
RST 5-3-VAD 1F-4-3-241/2 M	186-187	RST 5-3-VC 1A-1-3-226/5 M	190-191	RST 5-RKWT 5-644/2 M	154-155
RST 5-3-VAD 1F-4-3-241/5 M	186-187	RST 5-3-VCD 1A-1-3-226/0.3 M	190-191	RST 5-RKWT 5-644/5 M	154-155
RST 5-3-VB 1A-1-1-226/0.3 M	188-189	RST 5-3-VCD 1A-1-3-226/0.6 M	190-191	RST 5-RKWT 5-644/10 M	154-155
RST 5-3-VB 1A-1-1-226/0.6 M	188-189	RST 5-3-VCD 1A-1-3-226/1 M	190-191	RST 5U-755/6 F	98-99
RST 5-3-VB 1A-1-1-226/1 M	188-189	RST 5-3-VCD 1A-1-3-226/1.5 M	190-191	RST 5U-755/12 F	98-99

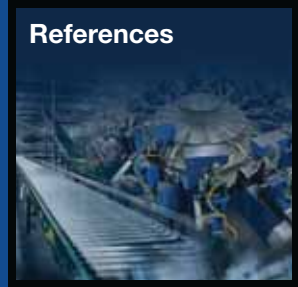

Be Certain with Belden

Part Number Index

Part Number	Page No.	Part Number	Page No.	Part Number	Page No.
RST 5U-755/15 F	98-99	RST 5-VAD 3C-4-2-259/1.5 M	186-187	RSTS 4-182/2 M	86-87
RST 5U-755/20 F	98-99	RST 5-VAD 3C-4-2-259/2 M	186-187	RSTS 4-182/5 M	86-87
RST 5U-673/6 F	98-99	RST 5-VAD 3C-4-2-259/5 M	186-187	RSTS 4-182/10 M	86-87
RST 5U-673/12 F	98-99	RST 8-282/2 M	74-75	RSTS 4-288/2 M	86-87
RST 5U-673/15 F	98-99	RST 8-282/5 M	74-75	RSTS 4-288/5 M	86-87
RST 5U-673/20 F	98-99	RST 8-282/10 M	74-75	RSTS 4-288/10 M	86-87
RST 5U-RKT 5U-673/3 F	162-163	RST 8-627/2 M	76-77	RSTS 5-183/2 M	86-87
RST 5U-RKT 5U-673/6 F	162-163	RST 8-627/5 M	76-77	RSTS 5-183/5 M	86-87
RST 5U-RKT 5U-673/12 F	162-163	RST 8-627/10 M	76-77	RSTS 5-183/10 M	86-87
RST 5U-RKT 5U-673/15 F	162-163	RST 8-RKT 8-6-268/2 M	150-151	RSTS 5-298/2 M	86-87
RST 5U-RKT 5U-755/3 F	162-163	RST 8-RKT 8-6-268/5 M	150-151	RSTS 5-298/5 M	86-87
RST 5U-RKT 5U-755/6 F	162-163	RST 8-RKT 8-6-268/10 M	150-151	RSTS 5-298/10 M	86-87
RST 5U-RKT 5U-755/12 F	162-163	RST 8-RKT 8-6-337/2 M	150-151	RSTS 8-184/2 M	86-87
RST 5U-RKT 5U-755/15 F	162-163	RST 8-RKT 8-6-337/5 M	150-151	RSTS 8-184/5 M	86-87
RST 5U-RKWT 5U-673/3 F	162-163	RST 8-RKT 8-6-337/10 M	150-151	RSTS 8-184/10 M	86-87
RST 5U-RKWT 5U-673/6 F	162-163	RST 8-RKT 8-282/0.3 M	150-151	RSTS 8-299/2 M	86-87
RST 5U-RKWT 5U-673/12 F	162-163	RST 8-RKT 8-282/0.6 M	150-151	RSTS 8-299/5 M	86-87
RST 5U-RKWT 5U-673/15 F	162-163	RST 8-RKT 8-282/1 M	150-151	RSTS 8-299/10 M	86-87
RST 5U-RKWT 5U-755/3 F	162-163	RST 8-RKT 8-282/1.5 M	150-151	RS-TU	237
RST 5U-RKWT 5U-755/6 F	162-163	RST 8-RKT 8-282/2 M	150-151	RS-TU B	237
RST 5U-RKWT 5U-755/12 F	162-163	RST 8-RKT 8-282/5 M	150-151	RS-TU C	237
RST 5U-RKWT 5U-755/15 F	162-163	RST 8-RKT 8-627/0.3 M	152-153	RSUF 12-256/5 M	134-135
RST 5-VAD 3C-4-1-228/0.3 M	186-187	RST 8-RKT 8-627/0.6 M	152-153	RSUF 12-256/10 M	134-135
RST 5-VAD 3C-4-1-228/0.6 M	186-187	RST 8-RKT 8-627/1 M	152-153	RSUF 12-256/15 M	134-135
RST 5-VAD 3C-4-1-228/1 M	186-187	RST 8-RKT 8-627/2 M	152-153	RSUF 12-256/20 M	134-135
RST 5-VAD 3C-4-1-228/1.5 M	186-187	RST 8-RKT 8-627/5 M	152-153	RSUF 19-242/5 M	134-135
RST 5-VAD 3C-4-1-228/2 M	186-187	RST 8-RKWT 8-6-268/2 M	150-151	RSUF 19-242/10 M	134-135
RST 5-VAD 3C-4-1-228/5 M	186-187	RST 8-RKWT 8-6-268/5 M	150-151	RSUF 19-242/15 M	134-135
RST 5-VAD 3C-4-1-259/0.3 M	186-187	RST 8-RKWT 8-6-268/10 M	150-151	RSUF 19-242/20 M	134-135
RST 5-VAD 3C-4-1-259/0.6 M	186-187	RST 8-RKWT 8-6-337/2 M	150-151	RSUF 19-RKWU 19-355/2 M	184-185
RST 5-VAD 3C-4-1-259/1 M	186-187	RST 8-RKWT 8-6-337/5 M	150-151	RSUF 19-RKWU 19-355/5 M	184-185
RST 5-VAD 3C-4-1-259/1.5 M	186-187	RST 8-RKWT 8-6-337/10 M	150-151	RSUF 19-RKWU 19-355/10 M	184-185
RST 5-VAD 3C-4-1-259/2 M	186-187	RST 8-RKWT 8-282/0.3 M	150-151	RSV	236
RST 5-VAD 3C-4-1-259/5 M	186-187	RST 8-RKWT 8-282/0.6 M	150-151	RSV M23	237
RST 5-VAD 3C-4-2-228/0.3 M	186-187	RST 8-RKWT 8-282/1 M	150-151	RSW 20-603/2 M	116-117
RST 5-VAD 3C-4-2-228/0.6 M	186-187	RST 8-RKWT 8-282/1.5 M	150-151	RSW 20-603/5 M	116-117
RST 5-VAD 3C-4-2-228/1 M	186-187	RST 8-RKWT 8-282/2 M	150-151	RSW 20-603/10 M	116-117
RST 5-VAD 3C-4-2-228/1.5 M	186-187	RST 8-RKWT 8-282/5 M	150-151	RSW 201-678/6 F	108-109
RST 5-VAD 3C-4-2-228/2 M	186-187	RST 8-RKWT 8-627/0.3 M	152-153	RSW 201-678/12 F	108-109
RST 5-VAD 3C-4-2-228/5 M	186-187	RST 8-RKWT 8-627/0.6 M	152-153	RSW 201-678/15 F	108-109
RST 5-VAD 3C-4-2-259/0.3 M	186-187	RST 8-RKWT 8-627/1 M	152-153	RSW 201-678/20 F	108-109
RST 5-VAD 3C-4-2-259/0.6 M	186-187	RST 8-RKWT 8-627/2 M	152-153	RSW 201-678/30 F	108-109
RST 5-VAD 3C-4-2-259/1 M	186-187	RST 8-RKWT 8-627/5 M	152-153	RSW 30-601/2 M	120-121

Part Number Index

Part Number	Page No.	Part Number	Page No.	Part Number	Page No.
RSW 30-601/5 M	120-121	RSW 50-794/6 F	116-117	ZBR 5/10	238
RSW 30-601/10 M	120-121	RSW 50-794/12 F	116-117	ZBR 8/40	238
RSW 30-645/2 M	116-117	RSW 50-794/15 F	116-117	ZBS	238
RSW 30-645/5 M	116-117	RSW 50-794/20 F	116-117	ZBST	239
RSW 30-645/10 M	116-117	RSW 50-794/30 F	116-117	ZKS 1	237
RSW 30-731/6 F	116-117	RSW 501-742/6 F	112-113	ZKS 2	237
RSW 30-731/12 F	116-117	RSW 501-742/12 F	112-113	ZLU 4-30	54-55
RSW 30-731/15 F	116-117	RSW 501-742/15 F	112-113	ZLU 4L-30	54-55
RSW 30-731/20 F	116-117	RSW 501-742/20 F	112-113	ZLU 4-50	54-55
RSW 30-731/30 F	116-117	RSW 501-742/30 F	112-113	ZMS 19	240
RSW 301-619/6 F	108-109	RSW 501-755/6 F	112-113	ZV 2 4-3-225/2 M	206-207
RSW 301-619/12 F	108-109	RSW 501-755/12 F	112-113	ZV 2 4-3-225/5 M	206-207
RSW 301-619/15 F	108-109	RSW 501-755/15 F	112-113	ZV 2 4-3-225/10 M	206-207
RSW 301-619/20 F	108-109	RSW 501-755/20 F	112-113	ZVK	236
RSW 301-619/30 F	108-109	RSW 501-755/30 F	112-113	ZVK 2	236
RSW 301-738/6 F	108-109	RSW 601A-697/6 F	108-109	ZVKM	236
RSW 301-738/12 F	108-109	RSW 601A-697/12 F	108-109		
RSW 301-738/15 F	108-109	RSW 601A-697/15 F	108-109		
RSW 301-738/20 F	108-109	RSW 601A-697/20 F	108-109		
RSW 301-738/30 F	108-109	RSW 601A-697/30 F	108-109		
RSW 301-741/6 F	112-113	RSWU 12-ASB 8/LED 5-4-331/5 M	58-59		
RSW 301-741/12 F	112-113	RSWU 12-RKWU 12-256/2 M	184-185		
RSW 301-741/15 F	112-113	RSWU 12-RKWU 12-256/5 M	184-185		
RSW 301-741/20 F	112-113	RSWU 12-RKWU 12-256/10 M	184-185		
RSW 301-741/30 F	112-113	RSWU 12-SB 8/LED 3-333/5 M	56-57		
RSW 40-602/2 M	116-117	RSWUF 12-256/5 M	136-137		
RSW 40-602/5 M	116-117	RSWUF 12-256/10 M	136-137		
RSW 40-602/10 M	116-117	RSWUF 12-256/15 M	136-137		
RSW 40-637/6 F	116-117	RSWUF 12-256/20 M	136-137		
RSW 40-637/12 F	116-117	RSWUF 19-242/5 M	136-137		
RSW 40-637/15 F	116-117	RSWUF 19-242/10 M	136-137		
RSW 40-637/20 F	116-117	RSWUF 19-242/15 M	136-137		
RSW 40-637/30 F	116-117	RSWUF 19-242/20 M	136-137		
RSW 401-739/6 F	108-109	SB 8/LED 3-333/5 M	20-21		
RSW 401-739/12 F	108-109	SB 8/LED 3-333/10 M	20-21		
RSW 401-739/15 F	108-109	SBS 4/LED 3	18-19		
RSW 401-739/20 F	108-109	STS-Clip	239		
RSW 401-739/30 F	108-109	VAD 1A-1-3-M12-5	232-233		
RSW 50-777/6 F	108-109	VAD 1A-1-3-M8-3	234-235		
RSW 50-777/12 F	108-109	VAD 3C-4-1-M12-5	232-233		
RSW 50-777/15 F	108-109	VAD M12 1A-VAD 1A-1-3-226/0,4 M	230-231		
RSW 50-777/20 F	108-109	VAD M12 1A-VAD 1A-1-3-241/0,4 M	230-231		
RSW 50-777/30 F	108-109	VB 1A-1-2-M8-3	234-235		

Be Certain with Belden



Regarding the details in this catalog: Alterations may have been made to the product after the editorial deadline for this publication, namely 05/01/2011. The manufacturer reserves the right to alter the construction and form, manufacture different shades and amend the scope of delivery during the delivery period insofar as the alterations and differences are acceptable to the buyer while allowing for the seller's interests. Insofar as the seller or the manufacturer uses signs or numbers to mark the order or the ordered item, no rights may be derived from this alone. The illustrations may also contain accessories and special equipment which are not part of the mass-produced scope of delivery. Color differences are attributable to technical aspects of the printing process. This publication may also contain types and support services that are not made available/rendered in some countries. The information/details in this publication merely contain general descriptions or performance factors which, when applied in an actual situation, do not always correspond with the described form and may be amended by way of the further development of products. The desired performance factors shall only be deemed binding if these are expressly agreed on conclusion of the contract. This catalog by be used internationally. However, comments on statutory, legal, and fiscal provisions and effects only apply to the Federal Republic of Germany at the time of the editorial deadline for this publication. Please consult your pertinent seller about the provisions and effects that apply to your country and regarding the latest bidding version.

For complete **Terms and Conditions**, visit our website: www.lumberg-automationusa.com/terms.





lumbergautomation

A Belden BRAND

www.lumberg-automationusa.com

GLOBAL LOCATIONS

For worldwide Industrial Sales
and Technical Support, visit:
www.belden.com/industrial



AMERICAS

Belden Industrial Connectivity
1540 Orchard Drive
Chambersburg, PA 17201
Phone: 717-217-2299
Fax: 717-217-2279
www.lumberg-automationusa.com

EUROPE/AFRICA/MIDDLE EAST (EMEA)

Belden Deutschland GmbH
Im Gewerbepark 2
58579 Schalksmühle
GERMANY
Phone: +49-2355-8301
Fax: +49-2355-83-3 33
www.lumberg-automation.com